



www.groz-tools.com

TOOLS AND EQUIP MENT

FOR THE PROFESSIONAL



OUR STORY



**2 MILLION
SQUARE FEET
MANUFACTURING AREA**



**06
PLANTS**



**INDIA'S LARGEST
TOOLS MANUFACTURER**

**SALES
NETWORK**



**85
COUNTRIES**



**3000
WORKFORCE**

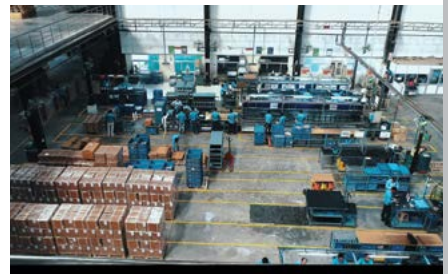

 **GROZ**



ISO 9001 : 2015
ISO 14001 : 2015
ISO 45001 : 2018



SA 8000 : 2014



Quality Assurance Statement

The satisfaction of all customers is the fundamental principle of the GROZ corporate philosophy

GROZ stands committed to the quality of its products and service with the assurance of complete back-up support

With a wide range of products, prompt service and vast experience, GROZ remains dedicated to the customer



INSIDE

I

PROFESSIONAL HAND TOOLS



STRIKING TOOLS

Indestructible Handle

Club Hammers	11
Sledge Hammers	12
Copper Head Sledge Hammers	14
Brass Head Sledge Hammers	15
Ball Pein Hammers	16
Blacksmith's/ Cross Pein Hammers	17
Claw Hammers	17

Steel Handle

Anti-shock Ball Pein Hammer	18
Anti-shock Drilling Hammer	18

Fibreglass Handle

Sledge Hammers	20
Ball Pein Hammers	21
Drilling Hammers	22
Engineer's Hammers	23
Blacksmith's/ Cross Pein Hammers	24
Claw Hammer	25
Axe	26
Dead Blow Hammers	27
Rubber Mallets	28
Double Face Plastic Mallet	29
Nail Punches Cushion Grip	30

IMPACT WRENCHES

Impact Wrenches	32
-----------------	----

TOOL STORAGE & ASSORTMENTS

27 Inch Rolling Tool Cabinet	34
27 Inch Rolling Tool Cabinet	36
27 Inch Rolling Tool Cabinet	38
Universal Tool Kit - 149 Piece	40
Automotive Tools Kit - 83 Piece	42
Nylon Tool Bags	44
Work Bench - Heavy Duty	45
Mini Tool Box with Lid	46
Cantilever Tool Box With Tools	48
5 Tray Cantilever Tool Box	50
Tool Cart Accessories - Magnetic	51
Magnetic Pads	52
Magnetic Tool Holders - Heavy Duty	53

TORQUE TOOLS

Ratcheting Torque Wrenches	54
Torque Wrenches - Cushion Grip	55
Classic Torque Wrenches	56
Aluminium Torque Wrenches	57
Torque Multipliers	58
Torque Extension Bars - 10 Pc Kit	59

AUTOMOTIVE TOOLS & ACCESSORIES

Strap Wrench	60
Tyre Levers	60

Pocket Pry Bars	61
13 Pc Automotive Maintenance Tool Kit	62
Magnetic Drain Plug Remover Tool	63
Gear Pullers	64
Quick Change Ratcheting Gear Pullers	65
Hydraulic Bottle Jacks	66
Hydraulic Floor Jack - 3 Ton	67
Hexagon Key Sets	68
7 Pc Insulation Screwdrivers Set	71

SPANNERS & PLIERS

Reversible Ratcheting Spanners	72
Ring Spanners	73
Double Open End Spanners	74
Insulation Pliers	75
Circclip Pliers	76
Adjustable Wrenches	76
Telescopic Wheel Wrench	77
Tap & Reamer Wrenches	78

HACKSAW FRAMES & BLADES

Handyman's Hacksaw	78
Super Cut Hi-Tension Hacksaw	79
Hacksaw Frame - Professional	79

VICES & CLAMPS

G Clamps - General Purpose	80
Mechanic's Vices / Bench Vices	80
Multi Purpose Vice	81

SOCKETS & ACCESSORIES

Hand Sockets	82
Socket Merchandiser	85
Impact Socket Hex	86
Socket Accessories	88
Socket Sets In Blow Moulded Cases	90
Hand Sockets Sets On Rails	92
Hand Socket Sets In Metal Cases	93
Slim Line Ratchet Handle	94
Round Head Ratchet Handle	95
Pear Head Ratchet Handle	95

II

LED WORKLIGHTS



WORKLIGHTS

Worklight - Cable Reel	97
Worklight - Impact Resistant	98
Worklight - Dual Power	100
Cordless Sitalamp - 3 Head Design	102
Site Lamp - AC Powered	104
Site Lamp With Tripod - AC Powered	105
Foldable Worklight - AC Powered	106
Worklight - Glare Free - Pocket Sized	107
Worklight - 270° Swivelling with Magnetic Base	108
Worklight - 360° Rotating Hook	109

Folding Worklight	110
Worklight - Intensity Control	112
Worklight - Intensity Control & Battery Display	114
Worklight - UV & Dual Charging	116
Folding Worklight - Intensity Control	118
3-in-1 Quick Connect Worklight	120
Inspection Light Flexible	122
Worklight - 360° Swivel	123
Inspection Lamp - Unbreakable	124
Underhood Light - Magnetic Ends	125
Underhood Light - High Intensity - Glare Free	126

FLASHLIGHTS

Spotlight - Waterproof	128
Pen Light - UV & Laser	129
Penlight	130
Penlight - Pivoting Head	131
Pick-Up Light Telescopic	132
Flashlight - Slim Pocket Size	133
Neck Light - Rechargeable	134
Flashlight - Superbright	135
Worklight - Slim Line	136
Worklight - Multiple Functions	137

HEAD LAMPS

Headlamp - Rechargeable With Hand Sensor	138
Headlamp - Dual Mode & Hand Sensor	139
Headlamp - High Powered Strip Light	140

FLOODLIGHTS

Floodlight - 12W	141
Floodlight - 15W	142
Floodlight - 15W Compact	143
Floodlight - 15W Super Cool	144
Floodlight - 18W Super Cool	145
Floodlight - 27W	146
Floodlight - 30W	147
Floodlight - 45W	148
Floodlight - 48W	149

LIGHT BARS

Light Bar - 36W	150
Light Bar - 72W	151
Light Bar - 120W	152



FLUID HANDLING



GREASE HANDLING

The Ultimate Lever Grease Gun	154
Lever Grease Gun Heavy Duty	154
Lever Grease Gun - Dual Piston	155
Lever Grease Guns Heavy Duty - V Series	156
Lever Grease Gun 'V' Series	156
Lever Grease Gun - Super Valve	157
Mini Lever Grease Gun	157
Pistol Grip Grease Gun	158

Mini Pistol Grease Gun - Deluxe	158
Mini Grease Gun Push Type	159
Air Operated Grease Gun	159
Battery Powered Grease Gun	160
USB Rechargeable Battery Grease Gun	162
Grease Gun Holder - Magnetic	163
Quick Lock Grease Coupler	164
Grease Coupler - Quick Disconnect	165
Hydraulic Couplers - Standard	166
Hydraulic Couplers - Professional	166
Hydraulic Couplers - Heavy Duty	167
Button Head Couplers	167
Grease Gun Hoses	168
Grease Gun Steel Extensions	168
Grease Cartridges	169
Ezee Lube Kit	169
Grease Fittings	170
Grease Feeders	171
Bucket Greaser with Quick Lock Coupler	172
Grease Pump - Heavy Duty	173
Bucket Greasers	174
Scoop & Swipe Set	175
Grease Pump - Foot Operated	176
Portable Greasing System	177
Air Operated Grease Ratio Pump 50:1	178
Grease Pump Kits with HD Trolley	180
Grease Pump Kits With Drum Cart	183
Grease Ratio Pump - High Volume	184
Grease Control Valve - Professional	185
Grease Control Valve - Booster	185
Grease Control Valve - Metered	186

OIL HANDLING

Lever Action Barrel Pump	187
Ezee Flow Pump	187
Rotary Barrel Pump	188
Rotary Barrel Pump - V Series	188
Bucket Oil Pumps	189
Bucket Oil Pump With Meter	189
Air Operated Transfer Pump	190
Air Operated Oil Ratio Pump - 6.5:1	191
Air Operated Oil Ratio Pump	192
Air Operated Stainless Steel Pump - 3:1	194
Oil Pump Kits With HD Trolley	195
Oil Pump Kits With Drum Cart	196
Electric Oil Pumps	197
Air Operated Double Diaphragm Pumps	198
Oil Management System	200
Mechanical Oil Meters	202
Mechanical Oil Control Gun	203
Electronic Pre-Set Oil Control Gun	204
Oil Control Guns	205
Transfer Gun	206
Oil Cans V Series	206
Hydraulic Oil Hoses	206
Measuring Jugs - Stackable	207
Flexible Spout Measures	208

Smart Funnels	208
Fuel & Oil Funnels	209
Conical Funnels	209
Plastic Funnel Set - 4 Pieces	210
Flexible Funnel	211

HOSE REELS

Metal Hose Reels	212
Air / Water Hose Reels - E Series	214
Air / Water Hose Reel	215

WASTE OIL HANDLING

Electric Waste Oil Pump	216
Air Operated Double Diaphragm Pumps	217
Waste Oil Drain Pressurized	218
Waste Oil Drain	219
Low Profile Truck Drain	220
Plastic Truck Drain	221
Drain Pan	222

FUEL HANDLING

Heavy Duty High Flow Electric Fuel Pumps - Explosion Proof	223
Heavy Duty Electric Fuel Pumps Explosion Proof	224
Continuous Duty Electric Diesel Pump	226
Electric Fuel Pump Continuous Duty - High Flow	227
Fuel Dispenser	228
Diesel Refilling System Mini Browser	229
Open Bowser AC Diesel Refilling System	230
Electric Diesel Pumps - V Series	231
Electric Diesel Pumps	232
Electric Diesel Pump - Heavy Duty	233
Industrial Rotary Drum Pumps	234
Rotary Booster Pump 3:1	235
Mechanical Diesel Meter	236
Mechanical Fuel Meter Oval Gear	237
Mechanical Fuel Meter In-line	238
Digital Oval Gear Fuel Meter	239
Digital Fuel Meter In-line	240
Digital Fuel Meter - Professional	241
Fuel Control Nozzles - Manual	242
Fuel Control Nozzles - Automatic	242
Fuel Control Nozzles Automatic - E Series	243
Fuel Control Nozzle Metered	243

Dual Plane Fuel Nozzle Swivels	244
Fuel Dispensing Kits	244
Filter Wrench	245
Portable Fuel Filter	245
Fuel Filter	246
Fuel Filter Spin-On Cartridge Style	247

DEF HANDLING

DEF Pumps Electric	248
DEF Dispenser	249
Electric DEF Transfer Pumps	250
DEF Transfer Systems	252
Battery Transfer Pump	254
Dry Cell DEF Pump	255
Rechargeable DEF Pump	256
Electric Drum/ IBC Pumps	257
Rotary Drum Pump Stainless Steel	258
Plastic Lever Pump	259
DEF Control Nozzle - Manual	260
DEF Control Nozzle - Automatic	260

SPECIALITY PUMPS

Nylon Chemical Pumps	261
Plastic Rotary Pump	261
Plastic Lever Pump - Value	262
Siphon Pumps	263
Siphon Pump With Back Flow Valve	264
Two-In-One Transfer Pump	265

DRUM HANDLING

Drum Trolley - Low Profile	266
Drum Wrench	266
4 Wheel Drum Dolly	267
Drum Cradle	267
Drum Trolleys - Heavy Duty	268
Drum Cart - Heavy Duty	270

AIR HANDLING

Air Blow Guns - Standard	271
Air Blow Gun Professional	271
Filter Regulator Combination	272
Filter Regulator & Lubricator - 2 Piece	272
Digital Air Pressure Gauge	273
Tyre Inflator Gauge for Cars	274
Tyre Inflator Gauge for Trucks	275
Tyre Pressure Gauge - Pen Type	276

NEW ADDITIONS

LOOK OUT
FOR
NEW!
THROUGHOUT
THE CATALOGUE

Anti-shock
Ball Pein Hammer



18

Anti-shock
Drilling Hammer



18

Dead Blow Hammers
Fibreglass Handle



27

Nail Punches
Cushion Grip



30

27 Inch
Rolling Tool Cabinet



34

27 Inch
Rolling Tool Cabinet



36

27 Inch
Rolling Tool Cabinet



38

Universal Tool Kit
149 Piece



40

Automotive Tools Kit
83 Piece



42

Work Bench
Heavy Duty



45

Mini Tool Box
with Lid



46

Tool Cart Accessories
Magnetic



51

Magnetic Pads



52

Torque Extension Bars
10 Pc Kit



59

**Pocket
Pry Bars**



61

**13 Pc Automotive
Maintenance Tool Kit**



62

**Magnetic Drain Plug
Remover Tool**



63

**Cordless Sitelamp
3 Head Design**



102

**Foldable Worklight
AC Powered**



106

**Worklight - Glare Free
Pocket Sized**



107

**3-in-1 Quick Connect
Worklight**



120

**Neck Light
Rechargeable**



134

**Flashlight
Superbright**



135

**Worklight
Slim Line**



136

**Worklight
Multiple Functions**



137

**Headlamp
Strip Light**



140

**Battery Powered
Grease Gun**

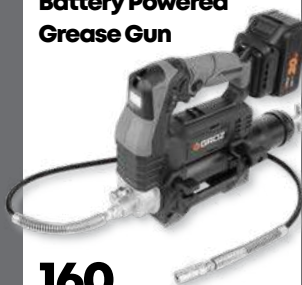

160

**Grease Gun Holder
Magnetic**



163

**Grease
Cartridges**



169

**Measuring Jugs
Stackable**



207

**Flexible
Funnels**



211

**Air / Water Hose Reels
E Series**



214

**Waste
Oil Drain**



219

**Open Bowser AC
Diesel Refilling System**



230

**Electric Diesel Pumps
V Series**



231

**Mechanical
Fuel Meter - Oval Gear**



237

**Mechanical
Fuel Meter In-line**



238

**Digital
Fuel Meter In-line**



240

**Fuel Control Nozzles
Automatic - E Series**



243

**Portable
Fuel Filter**



245

**Electric DEF Transfer
Pumps**



250

**Plastic
Lever Pump**



259

**Siphon Pump
With Back Flow Valve**



264

**Two-In-One
Transfer Pump**



265

**Tyre Pressure Gauge
Pen Style**



276

TERMS & CONDITIONS

Technical Data: All drawings, weights, dimensions, the descriptions & illustrations contained in the company's catalogues are only approximate and intended merely to give a general description of the goods described therein.

Specifications: Whilst every effort has been made to ensure accuracy of information given in this catalogue at the time of going to print, AUGUST 2025, our policy of continuous improvement determines the right to change specifications without notice. Customers must ensure that goods are suitable for the purpose intended.

Delay in Delivery: Delay in completion of work, delivery or in case of a contract for delivery by installments, delay in delivery of an installment shall not give rise to any liability upon the company whether or not any time of date is given in this respect and shall not entitle the customer to terminate the contract.

Liability: All goods are guaranteed to do the work for which they are designed. If the goods or any part thereof are defective solely as a result of faulty materials or workmanship of the company, the company's liability shall be limited, at its discretion either to replacing such goods or the defective parts. But no such liability shall arise unless notification of any defect is received by the company in writing within 90 days from the receipt of goods by the buyer and the allegedly defective goods are thereafter returned to the company carriage paid with appropriate pre-notification.

Indemnity: The customer shall indemnify the company against all claims in respect of any loss, injury or damage sustained by a third party arising from the sales of the goods to the buyer how so ever caused and also against all actions, proceedings, costs, claims, demands and expenses made, brought or claimed against the company in respect of the infringement of any patent, trademark or registered design.



01

**PROFESSIONAL
HAND TOOLS**

HAMMER MANUFACTURING UNIT

KAROLI, RAJASTHAN



300,000 sq. ft.
manufacturing facility

In-house capabilities

■ Tool & Die Making

■ CNC Forging Hammer

■ Modern Rotary Induction Hardening

■ Automated Assembly

■ Paint Shop

■ Consistent supply of volumes -
exceeding 1 million units/annum

HAMMER HEAD

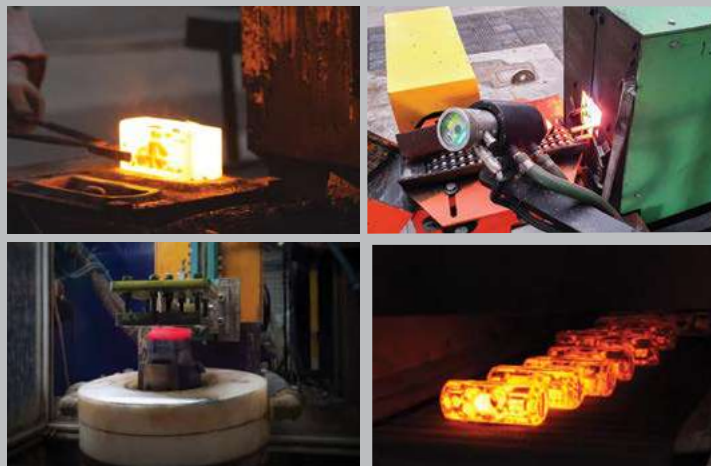
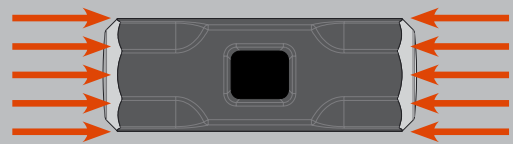

32%
ENHANCED LIFE

Using specially formulated chrome steel, each hammer head is carefully forged to prevent crack formation over time. Special heat treatment and tempering process ensures uniform hardness on all faces including the edges prevents mushrooming and accidents due to chipping. The hammers are DESIGNED TO ENDURE HARD STRIKES!

INDESTRUCTIBLE HANDLE



STEEL LOCKING PLATE

locks head to the handle eliminating loosening or dislodging

VULCANIZED RUBBER HANDLE

Absorbs impact & vibration reducing user fatigue

75X
STRONGER

SPRING STEEL BARS

Resist overstrike

PATENT PENDING

STEEL REINFORCED LANYARD HOLE



01

Club Hammers Indestructible Handle

CHID



A Club hammer is a small sledge hammer with relatively lighter weight and shorter handle

Handle

4 spring steel bars that run through the handle are locked with the hammer head using steel locking plate, ensuring that the head never gets dislodged

Ergonomic rubber grip handle absorbs vibration and reduces fatigue

Special bonding process ensures that the handle & head never get loose

Head

Available in 2 types

BS 876

For material, hardness & performance



SANS 387:2014



SPECIFICATIONS

WORKING TEMPERATURE RANGE	-10°C TO 50°C
---------------------------	---------------

WARNING*

Do not strike objects harder than 46 HRC. Striking items of a greater hardness is liable to cause fracture or chipping

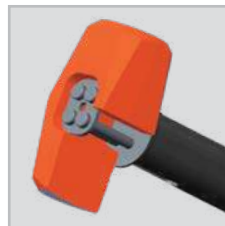

Steel Locking Plate



4 Spring Steel Bars



Ergonomic Rubber Grip Handle

a. Heavy Duty 50-58 HRC Head

Forged from special steel, the hammer head is induction case hardened 50-58 HRC. These hammers are especially useful in demolition work where the struck surface is softer than the hammer head

UTILITY

- Driving in stakes
- Metal-forming
- Setting bolts
- Minor demolition work

ORDERING INFORMATION

CAT NR.	HEAD WEIGHT		OVERALL LENGTH		BOX QTY.
	(LBS)	(KG)	(INCH)	(MM)	
* CHID/2.5/12	2.5	1.1	12	300	8
* CHID/4/12	4	1.8	12	300	8
CHID/4/16	4	1.8	16	400	8

* Best Seller

b. Soft Face 30 HRC Head

Forged from special steel, the hammer head is induction case hardened & then tempered to reduce hardness within 30-35 HRC. Softer head is designed to mushroom when striking harder base materials. Prevents damage to struck work pieces

UTILITY

- Metal forming
- Over ground mining
- Maintenance of cutting tools

ORDERING INFORMATION

CAT NR.	ORD NR.	HEAD WEIGHT		OVERALL LENGTH		BOX QTY.
		(LBS)	(KG)	(INCH)	(MM)	
CHID/SF/2.5/12	34550	2.5	1.1	12	300	8
CHID/SF/4/12	34551	4	1.8	12	300	8

02

Sledge Hammer Indestructible Handle

The 'BIG BOY' of hammers, Groz Sledge Hammers with patented Indestructible handle are designed to take a heavy beating

Handle

4 - 6 spring steel bars that run through the handle are locked with the hammer head using steel locking plates ensuring that the head never gets dislodged

Shorter handles 12" - 16" (300mm - 400mm) come with 4 spring steel bars. These hammers are useful in automotive applications

Longer handles come with 6 spring steel bars for added strength

Ergonomic rubber grip handle absorbs vibration and reduces fatigue

Special bonding process ensures that the handle & head never get loose

Head

Available in 2 types

a. Heavy Duty 50-58 HRC Head*

b. Soft Face 30 HRC Head

BS 876

For material, hardness & performance

SANS 387:2014



SPECIFICATIONS

WORKING TEMPERATURE RANGE	-10°C TO 50°C
---------------------------	---------------

WARNING*

Do not strike objects harder than 46 HRC. Striking items of a greater hardness is liable to cause fracture or chipping

a. Heavy Duty 50-58 HRC Head*

Forged from special steel, the hammer head is induction case hardened 50-58 HRC. These hammers are especially useful in demolition work where the struck surface is softer than the hammer head

UTILITY

- Driving in stakes
- Heavy demolition work
- Construction: fracturing stone & concrete
- Driving fence posts
- Police, fire & rescue
- Rebar work
- Railroads
- Bending & shaping metal

ORDERING INFORMATION

CAT NR.	HEAD WEIGHT		OVERALL LENGTH		BOX QTY.
	(LBS)	(KG)	(INCH)	(MM)	
SHID/6/24	6	2.7	24	600	4
SHID/6/30	6	2.7	30	750	4
* SHID/8/24	8	3.6	24	600	4
* SHID/8/30	8	3.6	30	750	4
SHID/8/36	8	3.6	36	900	4
SHID/10/30	10	4.5	30	750	4
SHID/12/30	12	5.5	30	750	4
* SHID/14/30	14	6.3	30	750	4
SHID/20/36	20	9	36	900	2

* Best Seller ◆ New

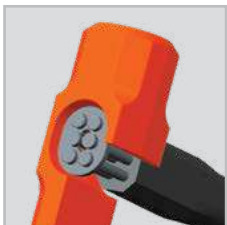

Steel Locking Plate



Spring Steel Bars



Ergonomic Rubber Grip Handle

b. Soft Face 30 HRC Head

Forged from special steel, the hammer head is induction case hardened & then tempered to reduce hardness within 30-35 HRC. Softer head is designed to mushroom when striking harder base materials. Prevents damage to struck work pieces.

UTILITY

- Agriculture
- Automotive
- Overground mining
- Railroad
- Maintenance of cutting tools

ORDERING INFORMATION

CAT NR.	HEAD WEIGHT		OVERALL LENGTH		BOX QTY.
	(LBS)	(KG)	(INCH)	(MM)	
SHID/SF/6/30	6	2.7	30	750	4
SHID/SF/8/30	8	3.6	30	750	4
SHID/SF/10/30	10	4.5	30	750	4
SHID/SF/12/30	12	5.5	30	750	4
SHID/SF/14/36	14	6.3	36	900	4

Copper head hammers
The ultimate safety tool are popular in
mining and automotive applications

Handle

4-6 spring steel bars that run through the
handle are locked with the hammer head
using steel locking plates ensuring that
the head never gets dislodged

Shorter handles 12" - 16" (300mm - 400mm)
come with 4 spring steel bars

Longer handles come with 6 spring steel
bars for added strength

Ergonomic rubber grip handle absorbs
shock & vibration reducing fatigue

Head

Hammer head is forged from 99.9% pure
copper for spark free use. Copper head
resists sparking & reduces marring of
most struck surfaces

Special bonding process ensures that the
handle and head never get loose



Spark -proof



UTILITY

- Metal forming
- Mining
- Underground mining
- Oil rigs
- Gas industry

SPECIFICATIONS

WORKING TEMPERATURE RANGE	-10°C TO 50°C
---------------------------	---------------

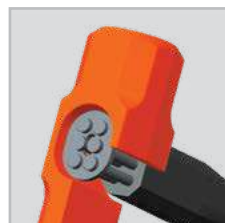

Steel Locking Plate



4 - 6 Spring Steel Bars



Ergonomic Rubber Grip Handle

ORDERING INFORMATION

CAT NR.	HEAD WEIGHT		OVERALL LENGTH		BOX QTY.
	(LBS)	(KG)	(INCH)	(MM)	
CHID/2.5/12/CU	2.5	1.1	12	300	8
CHID/2.5/16/CU	2.5	1.1	16	400	8
* CHID/4/12/CU	4	1.8	12	300	8
* SHID/8/24/CU	8	3.6	24	600	4
* SHID/14/30/CU	14	6.3	30	750	4

* Best Seller



04

Brass Head Sledge Hammers Indestructible Handle

SHID-BR

Brass head hammers are useful in combustible environments

Handle

4-6 spring steel bars that run through the handle are locked with the hammer head using steel locking plates ensuring that the head never get dislodged

Shorter handles 12" - 16" (300mm - 400mm) come with 4 spring steel bars

Longer handles come with 6 spring steel bars for added strength

Ergonomic rubber grip handle absorbs shocks & vibration hence reducing fatigue

Head

Drop forged brass head is spark resistant. It absorbs impact & reduces damage on the surface being hit.

These can be used safely in combustible environments

UTILITY

- Oil Rigs
- Gas Industry
- Automotive applications where the struck surface is soft



Mar Resistant Head



SPECIFICATIONS

WORKING TEMPERATURE RANGE	-10°C TO 50°C
---------------------------	---------------

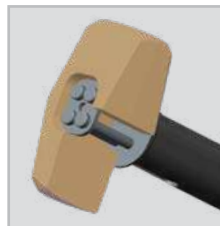

Steel Locking Plate



4-6 Spring Steel Bars



Ergonomic Rubber Grip Handle

ORDERING INFORMATION

CAT NR.	HEAD WEIGHT		OVERALL LENGTH		BOX QTY.
	(LBS)	(KG)	(INCH)	(MM)	
* SHID/2.5/12/BR	2.5	1.1	12	300	8
* SHID/4/12/BR	4	1.8	12	300	8
SHID/4/16/BR	4	1.8	16	400	8
◆ SHID/6/30/BR	6	2.7	30	750	4
◆ SHID/8/30/BR	8	3.6	30	750	4

* Best Seller

◆ New



A MUST HAVE TOOL for metal workers, The Ball Pein Hammer features a rounded end for pounding metals and a bevel on the other for regular hammering applications

Handle

2 spring steel bars that run through the handle are locked with the hammer head using steel locking plates ensuring that the head never gets dislodged

Ergonomic rubber grip handle absorbs shock & vibration reducing fatigue

Special bonding process ensures that the handle and head never get loose

UTILITY

- Bending & shaping metal
- Driving punches & chisels
- Concrete & stone work
- Hand forging
- Setting rivets
- Peen riveted & welded material
- Texturing face of metal

Head

Available in 2 types

SPECIFICATIONS

WORKING TEMPERATURE RANGE	-10°C TO 50°C
---------------------------	---------------

WARNING

Do not strike objects harder than 46 HRC. Striking items of a greater hardness is liable to cause fracture or chipping

a. Heavy Duty 50-58 HRC Head*

Forged from special steel, the hammer head is induction case hardened 50-58 HRC. These hammers are especially useful in applications where the struck surface is softer than the hammer head

ORDERING INFORMATION

CAT NR.	HEAD WEIGHT		OVERALL LENGTH		BOX QTY.
	(GMS)	(OZ)	(INCH)	(MM)	
BPID/16/14	450	16	14	350	8
BPID/20/14	565	20	14	350	8
* BPID/24/14	680	24	14	350	8
* BPID/32/14	900	32	14	350	8
BPID/48/14	1360	48	14	350	8

◆ New * Best Seller

BS 876

For material, hardness & performance

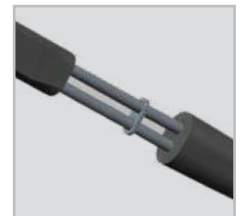

2 Spring Steel Bars

b. Soft Face 30 HRC Head

Forged from special steel, the hammer head is induction case hardened & then tempered to reduce hardness to within 30-35 HRC. Softer head is designed to mushroom when striking harder base materials. Prevents damage to struck work pieces

ORDERING INFORMATION

CAT NR.	HEAD WEIGHT		OVERALL LENGTH		BOX QTY.
	(GMS)	(OZ)	(INCH)	(MM)	
◆ BPID/SF/24/14	680	24	14	350	8

◆ New

06

Cross Pein Hammers Indestructible Handle

CPID

Handle

4 spring steel bars are locked with the hammer head using steel locking plates ensuring that the head never gets dislodged

Ergonomic rubber grip handle absorbs shock & vibration reducing fatigue

Head

Hammer head is forged from special steel & is induction case hardened to 50-58 HRC for extended life

Special bonding process ensures that the handle and head never get loose

UTILITY

- Heavy Forging
- Bending & Shaping Metal
- Spreading Metal
- Driving Punches & Chisels
- Driving Masonry Drills
- Concrete & Stone Work
- Starting Panel Pins & Tacks

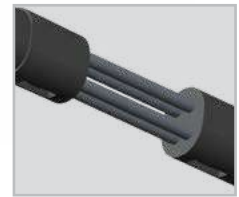

4 Spring Steel Bars

ORDERING INFORMATION

CAT NR.	HEAD WEIGHT		OVERALL LENGTH		BOX QTY.
	(LBS)	(KG)	(INCH)	(MM)	
CPID/2/16	2.5	1.15	16	400	8
* CPID/3/16	3.5	1.60	16	400	8

* Best Seller

SPECIFICATIONS

WORKING TEMPERATURE RANGE	-10°C TO 50°C
---------------------------	---------------

WARNING

Do not strike objects harder than 46 HRC. Striking items of a greater hardness is liable to cause fracture or chipping

07

Claw Hammer Indestructible Handle

CLID

Also known as a Nailing Hammer these are used in woodworking, prying & finishing jobs

Handle

2 spring steel bars are locked with the hammer head using steel locking plates ensuring that the head never gets dislodged

Ergonomic rubber grip handle absorbs shock & vibration reducing fatigue

Head

Hammer Head is forged from special steel &

induction case hardened 50-58 HRC for extended life

Special bonding process ensures that the handle and head never get loose. Well shaped, curved claw is tapered for maximum grip & higher leverage when gripping a nail

UTILITY

- Pulling Out Nails
- Lifting Floorboards
- Carpentry Work

SPECIFICATIONS

WORKING TEMPERATURE RANGE	-10°C TO 50°C
---------------------------	---------------

BS 876

For material, hardness & performance



2 Spring Steel Bars

ORDERING INFORMATION

CAT NR.	HEAD WEIGHT		OVERALL LENGTH		BOX QTY.
	(OZ)	(GMS)	(INCH)	(MM)	
CLID/16/13	16	450	13	330	12

WARNING

Do not strike objects harder than 46 HRC. Striking items of a greater hardness is liable to cause fracture or chipping. Do not use a claw hammer for striking cold chisels or for pulling out masonry nails

08

Anti-Shock Ball Pein Hammer

BPLV

A MUST HAVE TOOL for metal workers

Single-piece steel construction to absorb shock and reduce vibration

This also ensures that the head cannot get dislodged from the handle hence the hammer is unbreakable

Forged from special steel, the hammer head is induction case hardened to 50-58 HRC

The head features a rounded end for pounding metals and a bevel on the other for regular hammering applications

Handle with Cushioned TPR grip provides non-slip grip and increased control

Ideal for bending & shaping metal, driving punches & chisels, peen riveted or welded materials, setting rivets etc.

NEW!



ORDERING INFORMATION

CAT NR.	HEAD WEIGHT		OVERALL LENGTH		BOX QTY.
	(GMS)	(OZ)	(INCH)	(MM)	
BPLV/32/15	900	32	15	375	8

09

Anti-Shock Drilling Hammer

DHLV

Popularly called Stone Cutter's Hammers, these are designed for day-to-day demands of professional users

Single-piece steel construction absorbs shock and reduces vibration

This ensures the head cannot get dislodged from the handle hence the hammer is unbreakable.

Forged from special steel, the hammer head is induction case hardened to 50-58 HRC

Handle with Cushioned TPR grip provides slip-resistant grip and increased control

UTILITY

- Striking cold chisels, concrete chisels & brick bolsters
- Drive in stakes
- Rebar into the ground
- Break through concrete floors

NEW!



ORDERING INFORMATION

CAT NR.	HEAD WEIGHT		OVERALL LENGTH		BOX QTY.
	(LBS)	(KG)	(INCH)	(MM)	
DHLV/2.5/12	2.5	1.1	12	300	8

FIBREGLASS HANDLE

25%
WIDER NECK

Overstroke
protection

**EXCELLENT
STRENGTH &
DURABILITY**

Built, tested &
approved to
GROZ superior
quality &
specifications

FIBREGLASS HANDLE

Double injection
moulded
handle for
increased
strength, durability
& overstrike
protection

Well
balanced
hammer
head to
handle ratio
optimised
for balanced
blow each
time



Sledge Hammers are designed for heavy demolition and hammering applications

Head

Forged from fine-grained special steel the heads are induction hardened 50-58 HRC for increased durability

Handle

Lightweight yet durable dual injection moulded fibreglass handle for controlled and balanced swing

Designed with a 25% wider neck, handles are covered with a polypropylene jacket for protection against overstrikes

TPR grip on handle absorbs shock and vibration and provides a non-slip grip

Handles securely attached to the hammer head using a tough epoxy adhesive ensuring that the head does not loosen even with rough use

Available in two types

- a. Short Handle – 16" (400mm)**
- b. Long Handle – 36" (900mm)**

UTILITY

- Driving in stakes
- Metal forming
- Setting bolts
- Demolition jobs

BS 876
For material, hardness & performance

SANS 387:2014



ORDERING INFORMATION

CAT NR.	HEAD WEIGHT		OVERALL LENGTH		BOX QTY.
	(LBS)	(KG)	(INCH)	(MM)	
SHORT HANDLE					
SHFG/2.5/16	2.5	1.1	16	400	8
SHFG/4/16	4	1.8	16	400	8
LONG HANDLE					
SHFG/6/36	6	2.7	36	900	4
SHFG/8/36	8	3.6	36	900	4
SHFG/10/36	10	4.5	36	900	4
SHFG/12/36	12	5.5	36	900	2
SHFG/14/36	14	6.3	36	900	2
SHFG/16/36	16	7.3	36	900	2

WARNING

Do not strike objects harder than 46 HRC. Striking items of a greater hardness is liable to cause fracture or chipping

11

Ball Pein Hammers Fibreglass Handle

BPFG

A MUST HAVE TOOL for metal workers, The ball pein hammer features a rounded end for pounding metals and a bevel on the other for regular hammering applications

Head

Forged from fine-grained special steel the heads are induction hardened 50-58 HRC for increased durability

Handle

Lightweight yet durable dual injection moulded fibreglass handle for controlled and balanced swing

Designed with a 25% wider neck, handles are covered with a polypropylene jacket for protection against overstrikes

TPR grip on handle absorbs shock and vibration and provides a non-slip grip

Handles securely attached to the hammer head using a tough epoxy adhesive ensuring that the head does not fly away even with rough use

UTILITY

- Bending & shaping metal
- Driving punches & chisel
- Concrete & stone work
- Hand forging
- Setting rivets
- Peen riveted & welded material
- Texturing face of metal

BS 876

For material, hardness & performance



ORDERING INFORMATION

CAT NR.	HEAD WEIGHT		OVERALL LENGTH		BOX QTY.
	(GMS)	(OZ)	(INCH)	(MM)	
BPFG/4/11	113	4	11	275	10
BPFG/8/12	226	8	12	300	10
BPFG/12/13	340	12	13	330	10
BPFG/16/13	450	16	13	330	10
BPFG/24/14	680	24	14	350	10
BPFG/32/14	900	32	14	350	10
BPFG/40/16	1134	40	16	400	10
BPFG/48/16	1360	48	16	400	10

WARNING

Do not strike objects harder than 46 HRC. Striking items of a greater hardness is liable to cause fracture or chipping

Popularly called Stone Cutter's Hammers, these are ideal for day to day demands of construction professionals

Head

Fully forged head is induction hardened **50-58 HRC** and tempered for maximum strength and durability

Duly machined and polished faces are beveled to prevent chipping

Handle

Lightweight yet durable dual injection moulded fibreglass handle for controlled and balanced swing

Designed with a 25% wider neck, handles are covered with a polypropylene jacket for protection against overstrikes

TPR grip on handle absorbs shock and vibration and provides a non-slip grip

Handles securely attached to the hammer head using a tough epoxy adhesive ensuring that the head does not fly away even with rough use

UTILITY

- Striking cold chisels, concrete chisels & brick bolsters
- Drive in stakes
- Rebar into the ground
- Break through concrete floors

ASME
B107.400- 2018
BS 876
For material, hardness & performance



ORDERING INFORMATION

CAT NR.	HEAD SIZE		OVERALL LENGTH		BOX QTY.
	(LBS)	(GMS)	(INCH)	(MM)	
DHFG/2/11	2	900	11	280	8
DHFG/3/11	3	1300	11	280	8

WARNING

Do not strike objects harder than 46 HRC. Striking items of a greater hardness is liable to cause fracture or chipping



Head

Fully forged head is induction hardened **50-58 HRC** and tempered for maximum strength and durability

Duly machined and polished faces are beveled to prevent chipping

Handle

Lightweight yet durable dual injection moulded fibreglass handle for controlled and balanced swing

Designed with a 25% wider neck, handles are covered with a polypropylene jacket for protection against overstrikes

TPR grip on handle absorbs shock and vibration and provides a non-slip grip

Handles securely attached to the hammer head using a tough epoxy adhesive ensuring that the head does not fly away even with rough use

ASME
B107.400-2018

BS 876
For material, hardness & performance



UTILITY

- Tile & Drywall Demolition
- Setting brick & tile



ORDERING INFORMATION

CAT NR.	HEAD SIZE		OVERALL LENGTH		BOX QTY.
	(LBS)	(KG)	(INCH)	(MM)	
EHFG/2.5/14	2.5	1.14	14	350	8
EHFG/4/14	4	1.8	14	350	8

WARNING

Do not strike objects harder than 46 HRC. Striking items of a greater hardness is liable to cause fracture or chipping

Head

Fully forged head is induction hardened **50-58 HRC** and tempered for maximum strength and durability

Duly machined and polished faces are beveled to prevent chipping

Handle

Lightweight yet durable dual injection moulded fibreglass handle for controlled and balanced swing

Designed with a 25% wider neck, handles are covered with a polypropylene jacket for protection against overstrikes

TPR grip on handle absorbs shock and vibration and provides a non-slip grip

Handles securely attached to the hammer head using a tough epoxy adhesive ensuring that the head does not fly away even with rough use

UTILITY

Light metalworking & shaping jobs by -

- Metalworkers
- Welders
- Contractors
- Tradesmen
- Serious DIY'ers

ASME
B107.400- 2018
BS 876
For material, hardness & performance



ORDERING INFORMATION

CAT NR.	HEAD SIZE		OVERALL LENGTH		BOX QTY.
	(LBS)	(KG)	(INCH)	(MM)	
BHFG/2.5/14	2.5	1.14	14	350	8
BHFG/4/14	4	1.8	14	350	8

WARNING

Do not strike objects harder than 46 HRC. Striking items of a greater hardness is liable to cause fracture or chipping

15

Claw Hammer Fibreglass Handle

CLFG



Also known as a Nailing Hammer these are used in woodworking, prying & finishing jobs

Head

Hammer Head is forged from special steel & induction case hardened 50-58 HRC for extended life

Special bonding process ensures that the handle and head never get loose. Well shaped, curved claw is tapered for maximum grip & higher leverage when gripping a nail

Handle

Lightweight yet durable dual injection moulded fibreglass handle for controlled and balanced swing

Designed with a 25% wider neck, handles are covered with a polypropylene jacket for protection against overstrikes

TPR grip on handle absorbs shock and vibration and provides a non-slip grip

Handles securely attached to the hammer head using a tough epoxy adhesive ensuring that the head does not fly away even with rough use

UTILITY

- Pulling Out Nails
- Lifting Floorboards
- Carpentry Work

BS 876

For material, hardness & performance



ORDERING INFORMATION

CAT NR.	HEAD WEIGHT		OVERALL LENGTH		BOX QTY.
	(GMS)	(OZ)	(INCH)	(MM)	
CLFG/16/13	450	16	13	330	12

WARNING

Do not strike objects harder than 46 HRC. Striking items of a greater hardness is liable to cause fracture or chipping. Do not use a claw hammer for striking cold chisels or for pulling out masonry nails

Head

Forged from fine grained steel, the heads are induction hardened 50-55 HRC

Superior blade grinding technique provides a sharper edge for better contact and cleaner cuts

Painted heads with polished cutting edge that stays sharp longer than traditional axes

Handle

Durable fibreglass handle for controlled and balanced swing

Designed with a 25% wider neck, handles are covered with a polypropylene jacket for protection against overstrikes

Handles securely attached to the head using a tough epoxy adhesive

Lanyard Hole at the end of handle for easy storage

UTILITY

Designed to cut its way across wood fibers. Used for:

- Chopping wood
- knocking out chips



ORDERING INFORMATION

CAT NR.	HEAD WEIGHT		OVERALL LENGTH		BOX QTY.
	(LBS)	(KG)	(INCH)	(MM)	
AXE/FG/1.25/14	1.25	0.5	14	350	8
AXE/FG/4/36	4	1.8	36	900	4

17

Dead Blow Hammer Fibreglass Handle

DBFG



Dead blow hammers are commonly used for tasks that require a controlled strike without the risk of causing damage to the surface being struck

Head

Hollow head is filled with steel shots that create a dead blow effect for sustained impact & maximum force without rebound.

Polyurethane convex striking faces resist chipping and splitting. The heads provide a non-marring contact surface that eliminates denting, marring & damage to the struck surface.

Available with replaceable faces these can be used on many different materials & for different tasks. Replacement faces increase hammer life & improve usability of the product.

Handle

Lightweight yet durable dual injection moulded fibreglass handle for controlled and balanced swing. TPR grip on handle absorbs shock and vibration and provides a non-slip grip

UTILITY

- Automotive - Chassis repair, hubcap & transmission installation
- Fabrication in metal working
- Light striking in Carpentry
- In masonry for tile installation
- Dislodging stuck parts in wood working

NEW!

ORDERING INFORMATION

CAT NR.	WEIGHT		BOX QTY.
	(OZ)	(GMS)	
DBFG/28/12/UU	28	793	8
DBFG/45/13/UU	45	1275	8

Used for hitting softer materials preventing damage or marring of the underlying material

Single piece rubber head with two broad striking faces that helps distribute force across a broader area

Solid rubber head delivers a gentle but firm blow with minimal rebound. Heads accurately cured for high durability eliminating the possibility of cracks and breakage under pressure

Extensively used as a general purpose soft striking tool in automotive, industrial, brewery, DIY, carpentry, garden landscaping or worksite applications

Available with a choice of

- a. Black Head**
Ideal for use in damp conditions or outdoors
- b. White Head**
Will not discolour or leave marks on the work surface

Both heads are available with different handle types

- a. 14" Fibreglass Handle**
Double injected fibreglass handle with a polyjacket that protects the core and absorbs the impact of any missed strikes. Integrated TPR Grip for ultimate comfort
- b. 14" Hickory Wood Handle**
100% Genuine high density hickory wood handle is lightweight and contoured for comfortable grip
- c. 14" Hard Wood Handle**
Strong & sturdy wood handle for enhanced durability



ORDERING INFORMATION

CAT NR.	HEAD SIZE		HEAD COLOUR	BOX QTY.
	(OZ)	(GMS)		
FIBREGLASS HANDLE				
MLTR/16B/FG	16	453	Black	12
MLTR/16W/FG	16	453	White	12
MLTR/20B/FG	20	567	Black	12
MLTR/20W/FG	20	567	White	12
HICKORY WOOD HANDLE				
MLTR/16B/HW	16	453	Black	12
MLTR/16W/HW	16	453	White	12
MLTR/20B/HW	20	567	Black	12
MLTR/20W/HW	20	567	White	12
HARD WOOD HANDLE				
MLTR/16B/BW	16	453	Black	12
MLTR/16W/BW	16	453	White	12
MLTR/20B/BW	20	567	Black	12
MLTR/20W/BW	20	567	White	12



Automotive (Denting, fitting parts)



Construction



Metal Working



Carpentry



Multi-purpose striking tool useful for striking surfaces that could get damaged by steel hammers

Chrome plated head with 2 screw-in replaceable heads. Tubular steel handle shifts the weight balance towards the head for extra power in each blow

Available with a choice of heads:

a. Plastic Head

To lightly strike material without damaging or marring the surface. Used for piston cylinder assembly in engines, jewellery making etc.

b. Rubber Head

To deliver cushioned strike. Used in sheet metal & aluminium fabrication jobs, installation of wheel hub caps in automotive assembly & maintenance

c. Brass Head

Used in denting & painting shops, fitting jobs without causing any damage to the work surface

d. Copper Head

Provides a firm positive blow without any risk of marring the surface of highly finished expensive components



a. Plastic Head b. Rubber Head c. Brass Head d. Copper Head

APPLICATION

- Light Engineering Jobs
- Injection Moulding
- Denting & Painting
- Assembly & Fitting in automotive workshops
- Jewellery Making



ORDERING INFORMATION

CAT NR.	DESCRIPTION	BOX QTY.
HMR/SF/25	Mallet with plastic & rubber head	8
KIT/HMR/SF/4ST	Mallet with plastic & rubber head fitted, copper & brass head as spares	8
SPARE HEADS		
HD/PR/HMR/25	Red plastic head	10
HD/RB/HMR/25	Rubber head	10
HD/BR/HMR/25	Brass head	10
HD/CU/HMR/25	Copper head	10

NEW!

Individually forged from high quality steel

Precisely ground cutting edge
induction hardened (52-58 HRC) for
improved performance and durability

Rust inhibiting black oxide finish

Anti-slip TPR cushioned grip ensures
exceptional shock absorption and
provides non-slip performance

Flared striking end protects user
fingers from impact, improves stability
and control during use & also provides
a firm, controlled grip for precise and
agile striking

Designed for driving nail heads below
the surface of wood. The working
end is cupped to follow the nail head
without sliding off

These can also be used to remove
nails that have an exposed point.
Place the recessed tip against the
point of the nail and strike the punch
with a hammer to back the nail out of
the hole

Colour coded grips for quick size
identification



ORDERING INFORMATION

CAT NR.	TIP DIAMETER		COLOUR	BOX QTY.
	INCH	MM		
NLP/G/1-32	1/32	0.80	Black	200
NLP/G/1-16	1/16	1.6	Grey	200
NLP/G/3-32	3/32	2.4	Green	200
NLP/G/1-8	1/8	3	Orange	200
NLP/G/3A/ST	A set of 3 Nail Punches			200
	1/32" (0.8 mm)	1/16" (1.6 mm)	3/32" (2.4 mm)	
NLP/G/3B/ST	A set of 3 Nail Punches			200
	1/16" (1.6 mm)	3/32" (2.4 mm)	1/8" (3 mm)	



IMPACT & RATCHET WRENCHES

MACHANISMS

JUMBO HAMMER MECHANISM



Simplest technology which produces high torque instantly for tough applications

TWIN HAMMER MECHANISM

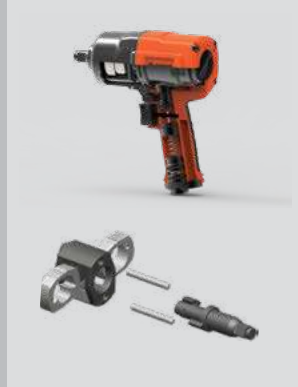

Balanced & powerful mechanism comprising of two fully forged hammers that work alternatively. With lower air consumption & low reaction force the system builds up torque smoothly, to its maximum level

IMPROVED TWIN HAMMER MECHANISM



Designed for higher torque & durability. Strong reinforced hammer frame can take higher impact for a longer time. Larger anvil provides a large contact area. Gives 25% more torque compared to twin hammer & enhances tool life by upto 3 times

PIN-LESS CLUTCH MECHANISM



High torque output with excellent power to weight ratio & fast run down for less frequent high torque applications

AIR EXHAUST

FRONT EXHAUST



Air is blown forward towards the working area. This is normally found in the simpler design models

REAR EXHAUST



This is the most popular design. Air is discharged down the handle and blown away from the working area

SIDE EXHAUST



The air is discharged from the side of the tool

HANDLE TYPE

PISTOL TYPE



STRAIGHT D-HANDLE TYPE



IPW - 201

3/8"

IPW - 301

1/2"



CE



CE

description	3/8" Impact Wrench	1/2" Impact Wrench
CONSTRUCTION	Aluminium	Aluminium
GRIP	-	-
MECHANISM	Jumbo Hammer	Twin Hammer
MAX. TORQUE *@15sec	360 Nm	1223 Nm
FREE SPEED	10,000 RPM	8,000 RPM
EXHAUST	Rear Exhaust	Front Exhaust
AIR INLET SIZE	1/4"	1/4"
AIR HOSE I.D.	3/8"	3/8"
AVG. AIR CONSUMPTION	71 LPM (2.5 CFM)	113 LPM (4 CFM)
MAX. NUT CAPACITY	M11	M16
NET WT.	1.35 KG	2.56 KG
OVERALL LENGTH	5-1/2" (140mm)	6.7" (171mm)
APPLICATION	<ul style="list-style-type: none"> • Tyre services & wheel alignment • Repair of white goods (fans, washing machines etc.) 	<ul style="list-style-type: none"> • Maintenance & repair of • Passenger Vehicles • Railways • Gear Units & Gear Boxes • Printing Press Machines • Assembly line of white goods (Fans, washing machines etc.)
USAGE INTENSITY	INTENSIVE	INTENSIVE
SPEED CONTROL	 <p>5 speed position control</p>	 <p>6 speed position control</p>

ORDERING INFORMATION

CAT NR.	BOX QTY.
IPW/201	12
IPW/301	6
IPW/401	4
IPW/501	1



IPW-201	IPW-301
IPW-401	IPW-501

IPW - 401 **3/4"**



CE

IPW - 501 **1"**



CE

3/4" Impact Wrench	1" Impact Wrench D - Handle
Aluminium	Aluminium
-	-
Improved Twin Hammer	Pin-less Clutch
2522 Nm	2522 Nm
6,700 RPM	4,000 RPM
Rear Exhaust	Side Exhaust
1/4"	3/8"
3/8"	1/2"
198 LPM (7 CFM)	238 LPM (8.4 CFM)
M24	M38
4.75 KG	12.06 KG
9.2" (235mm)	20.3" (515mm)
<ul style="list-style-type: none"> • MRO jobs in oil & gas industry • MRO jobs in paper processing plants 	<ul style="list-style-type: none"> • Truck garages, construction & mining equipment where huge impact power is required • Erection & commissioning of heavy equipment in power plants, sugar mill, cement plants & steel mills • MRO jobs in shipping Wards • Routine maintenance of wind mills

INTENSIVE



3 speed positive control, full power in reverse

INTENSIVE



3 speed position control

22

27 Inch Rolling Tool Cabinet

S-100 SERIES

CENTRAL LOCKING SYSTEM

High-security lock with 400 key combinations

UV-RESISTANT FINISH

Industrial-grade coating resists fading and corrosion

FULL EXTENSION HETTICH® BALL BEARING SLIDES

Provide complete tool visibility & easy retrieval

RUGGED MOBILITY

4 Heavy-duty castors
5" x 1.25" (125 x 30mm).
Rear castors with brakes for safety

ERGONOMIC HANDLE

For ease of movement

ANTI-SLIP LINERS

Minimize tool movement & vibrational impact



7 DRAWER

TROLLEY WT.

48 KG

DRAWER DETAILS

DRAWER	WIDTH		DEPTH		HEIGHT		NO. OF DRAWERS
	(INCH)	(MM)	(INCH)	(MM)	(INCH)	(MM)	
A	22-11/16	576	16-1/8	410	3	77	5
B	22-11/16	576	16-1/8	410	6	157	2

RTC-27-10D

NEW!

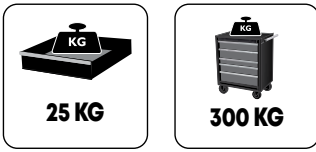

Manufactured from durable and sturdy steel sheet

Industrial grade, UV resistant powder coated finish prevents fading and corrosion

Reinforced drawer design with a load capacity of upto 25 kg per drawer

Drawers with **Hettich® Ball Bearing slides**, for easy movement and 100% opening of drawers giving full visibility

Drawers lined with anti-slip liners that protect the tools and reduce vibration

Central Locking system

High security lock with 400 key combinations

4 heavy-duty castors

5" x 1.25" (125mm x 30mm)

Rear castors with brakes for enhanced safety

Ergonomic handle for ease of movement

ORDERING INFORMATION

CAT NR.	NO. OF DRAWERS	DIMENSION		BOX QTY.
		(INCH)	(MM)	
RTC/27-10D/1/GRZ	7	27 x 18-25/64 x 40	680 x 467 x 1000	1
RTC/27-10D/2/GRZ	5	27 x 18-25/64 x 40	680 x 467 x 1000	1



5 DRAWER

TROLLEY WT.

43 KG

DRAWER DETAILS

DRAWER	WIDTH		DEPTH		HEIGHT		NO. OF DRAWERS
	(INCH)	(MM)	(INCH)	(MM)	(INCH)	(MM)	
A	22-11/16	576	16-1/8	410	3	77	2
B	22-11/16	576	16-1/8	410	6	157	2
C	22-11/16	576	16-1/8	410	9-29/64	240	1

23

27 Inch Rolling Tool Cabinet

S-10 SERIES

CENTRAL LOCKING SYSTEM

High-security lock with 400 key combinations

UV-RESISTANT FINISH

Industrial-grade coating resists fading and corrosion

FULL EXTENSION HETTICH® BALL BEARING SLIDES

Provide complete tool visibility & easy retrieval

RUGGED MOBILITY

4 Heavy-duty castors
5" x 1.25" (125 x 30mm).
Rear castors with brakes for safety

ERGONOMIC HANDLE

For ease of movement

ANTI-SLIP LINERS

Minimize tool movement & vibrational impact



7 DRAWER

TROLLEY WT.

64 KG

DRAWER DETAILS

DRAWER	WIDTH		DEPTH		HEIGHT		NO. OF DRAWERS
	(INCH)	(MM)	(INCH)	(MM)	(INCH)	(MM)	
A	22-11/16	576	16-1/8	410	3	77	5
B	22-11/16	576	16-1/8	410	6	157	2

RTC-27-10

**NEW!**

Manufactured from durable and sturdy steel sheet

Industrial grade, UV resistant powder coated finish prevents fading and corrosion

Reinforced drawer design with a load capacity of upto 25 kg per drawer

Drawers with **Hettich® Ball Bearing slides**, for easy movement and 100% opening of drawers giving full visibility

Drawers lined with anti-slip liners that protect the tools and reduce vibration

Central Locking system

High security lock with 400 key combinations

4 heavy-duty castors

5" x 1.25" (125mm x 30mm)

Rear castors with brakes for enhanced safety

Ergonomic handle for ease of movement

ORDERING INFORMATION

CAT NR.	NO. OF DRAWERS	DIMENSION		BOX QTY.
		(INCH)	(MM)	
RTC/27-10/3/GRZ	7	27 x 18-25/64 x 40	680 x 467 x 1000	1

24

27 Inch Rolling Tool Cabinet

S-20 SERIES

CENTRAL LOCKING SYSTEM

High-security lock with 400 key combinations

UV-RESISTANT FINISH

Industrial-grade coating resists fading and corrosion

FULL EXTENSION HETTICH® BALL BEARING SLIDES

Provide complete tool visibility & easy retrieval

RUGGED MOBILITY

4 Heavy-duty castors
5" x 2" (125 x 50mm)
Rear castors with brakes for safety



ERGONOMIC HANDLE

For ease of movement

BUILT TO ENDURE

Heavy Gauge Steel Construction

ANTI-SLIP LINERS

Minimize tool movement & vibrational impact



7 DRAWER

TROLLEY WT.

69 KG

DRAWER DETAILS

DRAWER	WIDTH		DEPTH		HEIGHT		NO. OF DRAWERS
	(INCH)	(MM)	(INCH)	(MM)	(INCH)	(MM)	
A	22-11/16	576	16-1/8	410	3	77	5
B	22-11/16	576	16-1/8	410	6	157	2

RTC-27-20

**NEW!****45 KG****500 KG**

Manufactured from heavy gauge steel sheet for industrial grade, heavy-duty performance and enhanced durability

Industrial grade, UV resistant powder coated finish prevents fading and corrosion

Reinforced drawer design with a load capacity of upto 45 kg per drawer

Drawers with **Hettich® Ball Bearing Slides**, for easy movement and 100% opening of drawers giving full visibility

Drawers lined with anti-slip liners that protect the tools and reduce vibration.

Central Locking system

High security lock with 400 key combinations

4 heavy-duty castors

5" x 2" (125mm x 50mm)

Rear castors with brakes for enhanced safety

Ergonomic handle for ease of movement

ORDERING INFORMATION

CAT NR.	NO. OF DRAWERS	DIMENSION		BOX QTY.
		(INCH)	(MM)	
RTC/27-20/1/GRZ	7	27 x 18-25/64 x 40	680 x 467 x 1000	1

25

**Universal Tool Kit
149 Piece**

NEW!

149 Piece Automotive Tool Kit comes in a 7 Drawer Portable Workstation (S-10D)

A versatile set with an organized layout, makes it convenient to find tools

Ideal for maintenance and service work on automobiles



Tools supplied with trolley

	QTY.	CONTENT OF TOOL TROLLEY	SIZE	IMAGE
TRAY 1	7 pcs	1/4" Hex Bit Sockets	3, 4, 5, 6, 7, 8, 10 mm	
	13 pcs	1/4" Hex Sockets	4, 4.5, 5, 5.5, 6, 7, 8, 9, 10, 11, 12, 13, 14 mm	
	3 pcs	1/4" Slotted Bit Sockets	4, 5.5, 7 mm	
	3 pcs	1/4" Philips Bit Sockets	PH1, PH2, PH3	
	8 pcs	1/4" Torx Bit Sockets	T8, T10, T15, T20, T25, T27, T30, T40	
	9 pcs	1/4" Hex Sockets Deep	5, 6, 7, 8, 9, 10, 11, 12, 13 mm	
	1 pc	1/4" Ratchet Handle		
	3 pcs	1/4" Pozi Bit Sockets	PZ1, PZ2, PZ3	
	3 pcs	1/4" Extension Bar	50, 100, 150 mm	
	1 pc	1/4" Universal Joint		
	1 pc	Spinner Handle	1/4"	
	1 pc	Sliding T Bar	1/4"	
	22 pcs	1/2" Hex Sockets	8, 9, 10, 11, 12, 13, 14, 15, 16, 17, 18, 19, 20, 21, 22, 23, 24, 25, 26, 27, 30, 32 mm	
	1 pc	Sliding T Bar	1/2"	
	2 pcs	1/2" Spark Plug Socket	16, 21 mm	
	1 pc	1/2" Ratchet handle		
	1 pc	1/2" Power Bar	375 mm	
	2 pcs	1/2" Extension Bar	125, 250 mm	
	1 pc	Ratcheting Torque Wrench	40-200 Nm	
	1 pc	1/2" Universal Joint		



	QTY.	CONTENT OF TOOL TROLLEY	SIZE	IMAGE
TRAY 2	1 pc	Combination Plier	200 mm	
	1 pc	Diagonal Cutting Plier	200 mm	
	1 pc	Long Nose Plier	200 mm	
	1 pc	Water Pump Plier	250 mm	
	1 pc	Circlip Plier - Internal Straight	175 mm	
	1 pc	Circlip Plier - Internal Bent	175 mm	
	1 pc	Circlip Plier - External Straight	175 mm	
	1 pc	Circlip Plier - External Bent	175 mm	
	1 pc	Adjustable Wrench	375 mm	
	1 pc	Locking Plier	250 mm	
TRAY 3	25 pcs	Offset Combination Spanners	6, 7, 8, 9, 10, 11, 12, 13, 14, 15, 16, 17, 18, 19, 20, 21, 22, 23, 24, 25, 26, 27, 28, 29, 30 mm	
TRAY 4	7 pcs	Flat Screwdriver	3x75, 4x100, 4x100, 6.5x38, 6.5x100, 6.5x150, 8.0x150 mm	
	4 pcs	Phillips Screwdriver	PH1x75, PH2x100, PH2x38, PH3x150	
	Set of 8 pcs	Tamper Torx Star Keys	T9, T10, T15, T20, T25, T27, T30, T40	
	1 pc	LED Flashlight	Extends from 17-55 cm, with Telescopic Magnetic Pick-Up	
	Set of 9 pcs	Hex Key Set with Ball End - Extra Long - Metric	1.5, 2, 2.5, 3, 4, 5, 6, 8, 10 mm	

ORDERING INFORMATION

CAT NR.	BOX QTY.
RTC/27-10D/1/148/AU	1

Automotive Tools Kit 83 Piece

84 Piece Automotive Tool Kit comes in a 7 Drawer Portable Workstation (S-10D)

A versatile set with an organized layout, makes it convenient to find tools

Ideal for maintenance and service work on automobiles

NEW!



Tools supplied with trolley

	QTY.	CONTENT OF TOOL TROLLEY	SIZE	IMAGE
TRAY 1	17 pcs	1/2" Hex Sockets	8, 10, 11, 12, 13, 14, 15, 16, 17, 18, 19, 21, 22, 24, 27, 30, 32 mm	
	5 pcs	1/2" Hex Sockets Deep	10, 14, 17, 19, 22 mm	
	1 pc	Ratchet handle	1/2"	
	1 pc	Sliding T Bar	1/2"	
	1 pc	L Handle	1/2"	
	1 pc	Universal Joint	1/2"	
	2 pcs	1/2" Extension Bar	5", 10"	
	2 pcs	1/2" Spark Plug Socket	16, 21 mm	
	2 pcs	Adaptors	1/2 F x 3/4 M, 1/2 F x 3/8 M	
	1 pc	Combination Plier	200 mm	
	1 pc	Diagonal Cutting Plier	175 mm	
	1 pc	Long Nose Plier	175 mm	
	1 pc	Circlip Plier - Internal Straight	150 mm	
	1 pc	Circlip Plier - Internal Bent	150 mm	
	1 pc	Circlip Plier - External Straight	150 mm	
	1 pc	Circlip Plier - External Bent	150 mm	
	Set of 9 pcs	Hex Key Set with Ball End - Extra Long - Metric	1.5, 2.0, 2.5, 3.0, 4.0, 5.0, 6.0, 8.0, 10.0 mm	
	1 pc	20 leaf - Feeler Gauge	Blade Length: 150 mm	



	QTY.	CONTENT OF TOOL TROLLEY	SIZE	IMAGE
TRAY 2	4 pcs	Pin Punch Set	1/16", 1/8", 3/16" & 5/32"	
	1 pc	Ball Pein Hammer	Head Weight: 24 oz., Handle Length: 14"	
	1 pc	Plastic Mallet	Head Dia: 25mm	
	1 pc	Chisels	Blade Width: 1" (25 mm), Overall Length: 10" (250 mm)	
	1 pc	Cat Bar	16" (400 mm)	
	1 pc	Hacksaw Frame	12" with Bi-Metal Blade	
	1 pc	Adjustable Wrench	10" (250 mm)	
	1 pc	Water Pump Plier	10" (250 mm)	
	1 pc	Professional Retra Knife	KNV/R/7	
	1 pc	Locking Plier	10" (250 mm)	
TRAY 3	12 pcs	Double Open End Spanner Set	6 × 7, 8 × 9, 10 × 11, 12 × 13, 14 × 15, 16 × 17, 18 × 19, 20 × 22, 21 × 23, 24 × 27, 25 × 28, 30 × 32 mm	
	12 pcs	Ring Spanner Set	6 × 7, 8 × 9, 10 × 11, 12 × 13, 14 × 15, 16 × 17, 18 × 19, 20 × 22, 21 × 23, 24 × 27, 25 × 28, 30 × 32 mm	
	2 pc	Flat Screwdriver	6.5 × 100, 8 × 150 mm	
	2 pc	Phillips Screwdriver	PH 1 × 75, PH 2 × 100	

ORDERING INFORMATION

CAT NR.	BOX QTY.
RTC/27-10D/1/90/AU	1

Durable, high quality water and abrasion resistant denier polyester tool bags. Double layered construction for enhanced durability

Tool Bags

Wide opening for easy access to contents

Easy pull heavy duty zipper

Handle stitching area reinforced for maximum durability

Rigid and waterproof base with TPR knobs to prevent damage from floor

Shoulder strap with cushioned rubber reinforcement on shoulder level

Back Pack

Multiple pockets and division for organized tooling

Safe and secure laptop and A4 document compartment

Cushioned shoulder straps for ergonomic and convenient carriage

Dual zipper closure enables opening from both ends



Tools not included

TOOL BAGS



NTB-3
Medium



NTB-1
Large



NTB-2
X-Large

BACK PACK



NTB-4

ORDERING INFORMATION

CAT NR.	LOAD CAPACITY		DIMENSIONS		SIZE	BOX QTY.
	(KG)	(LBS)	(INCH)	(MM)		
NTB/1	30	66	16.5 × 10.2 × 11.8	420 × 260 × 300	Large	1
NTB/2	60	132	17.9 × 11.0 × 11.8	455 × 280 × 300	X-Large	1
NTB/3	10	22	12 × 9 × 5.5	300 × 225 × 140	Medium	1
NTB/4	-	-	19.2 × 13.7 × 16.9	490 × 350 × 430	-	1

28

Work Bench Heavy Duty

WBN

NEW!

Built to perform. Engineered to last!

The Groz Work Bench is a rugged, heavy-duty solution for workshops, garages and industrial environments

Heavy-duty construction

14-gauge mild steel structure offers excellent durability and strength for industrial use. Can easily handle loads upto 545 kg (1200 lbs)

Welded worktop with end stops

5/64" (2 mm) thick top is welded to the frame for strength, with integrated back and side stops to prevent parts from rolling off

Adjustable foot pads

Designed for stable use on uneven surfaces

Lower storage shelf

Keeps essential tools and components within easy reach

Powder-coated finish

Provides resistance to rust and corrosion for long-term performance

Comes in knocked down condition. Just follow the included manual for easy assembly (hardware included)



SPECIFICATIONS

LOAD BEARING CAPACITY	545 KG	1200 LBS

ORDERING INFORMATION

CAT NR.	DIMENSION		BOX QTY.
	(INCH)	(MM)	
WBN/60-20/1/OR/GRZ	60-1/16 × 30-15/16 × 36-7/16	1525 × 785 × 925	1

29

Mini Tool Box with Lid

EASY STORAGE

Top compartment with lid that opens at 90°

BUILT TO ENDURE

Manufactured from 0.60 mm (24 gauge) steel with powder coated gloss finish

FULL EXTENSION HETTICH® BALL BEARING SLIDES

Provide complete tool visibility & easy retrieval



ANTI-SLIP LINERS

Minimize tool movement & vibrational impact

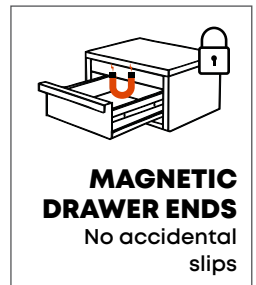

MAGNETIC DRAWER ENDS

No accidental slips



2 DRAWER WITH LID

DRAWER DETAILS

DRAWER	WIDTH		DEPTH		HEIGHT	
	(INCH)	(MM)	(INCH)	(MM)	(INCH)	(MM)
A	10-19/32	269	5-55/64	149	19/32	15
B	9-29/64	240	5-45/64	145	1-3/8	35
C	9-29/64	240	5-45/64	145	2-9/32	58

NEW!



The Groz Mini Tool Box is ideal for organizing small tools like nuts, bolts, grease fittings & caps, spanners, allen keys, screwdrivers, voltage testers etc.

Manufactured from 0.60 mm (24 gauge) steel with corrosion resistant powder coated gloss finish

Features two drawers and a top compartment with lid that opens at 90°

Hettich® Ball Bearing Slides ensure smooth and effortless drawer movement

Magnetic drawer locking mechanism; Neodymium magnets prevent drawers from opening even if the tool box is turned upside-down

Drawers and top compartment are lined with vinyl sheet to prevent scratches

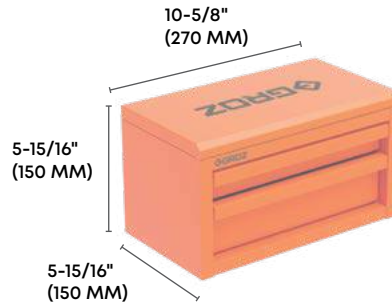

ORDERING INFORMATION

CAT NR.	COLOUR	BOX QTY.
TCHL/11-10D/1/BL/GRZ	Classic Black	4
TCHL/11-10D/1/W1/GRZ	Cool Grey	4
TCHL/11-10D/1/BU19/GRZ	Bossy Blue	4
TCHL/11-10D/1/RD/GRZ	Fiery Red	4
TCHL/11-10D/1/OR12/GRZ	Royal Purple	4
TCHL/11-10D/1/GN16/GRZ	Aqua Lux	4
TCHL/11-10D/1/OR/GRZ	Vibrant Orange	4

Available in 7 colours



Classic Black



Cool Grey



Bossy Blue



Fiery Red



Royal Purple



Aqua Lux



Vibrant Orange

Cantilever Tool Box with Tools

84 pcs tool assortment in metric sizes for use in automotive workshops & service stations

Tool box manufactured from heavy gauge steel sheet

Rugged construction to withstand repeated use in tough conditions



MTB/5/84/AU
84 Piece Mechanic's Tools Kit

QTY.	CONTENT	SIZE
1 Set	Hexagon Key Set (set of 9 pcs)	With Ball End - Extra Long - Metric - 1.5, 2.0, 2.5, 3.0, 4.0, 5.0, 6.0, 8.0, 10 mm
12 pcs	Double Open End Spanner Set	6 × 7, 8 × 9, 10 × 11, 12 × 13, 14 × 15, 16 × 17, 18 × 19, 20 × 22, 21 × 23, 24 × 27, 25 × 28, 30 × 32
12 pcs	Ring Spanner Set	6 × 7, 8 × 9, 10 × 11, 12 × 13, 14 × 15, 16 × 17, 18 × 19, 20 × 22, 21 × 23, 24 × 27, 25 × 28, 30 × 32
4 pcs	Pin Punch Set	1.5, 2.5, 3, 4 mm
2 pcs	Flat Screwdriver	6.5 × 125 mm; 8 × 150 mm
2 pcs	Philips Screwdriver	1 × 80 mm; 2 × 100 mm
1 pc	Side Cutting Plier	7" (175 mm)
1 pc	Long Nose Plier	7" (175 mm)
1 pc	Combination Plier	8" (200 mm)
1 pc	Circlip Plier - Bent External	6" (150 mm)
1 pc	Circlip Plier - Bent Internal	6" (150 mm)
1 pc	Circlip Plier - Straight External	6" (150 mm)
1 pc	Circlip Plier - Straight Internal	6" (150 mm)
1 pc	Ball Pein Hammer	Head weight - 24 oz., Handle length - 14"
1 pc	Plastic Mallet	25 mm

QTY.	CONTENT	SIZE
1 pc	Chisel	Blade Width - 1"(25 mm), Overall Length - 10" (250 mm)
1 pc	Cat Bar	16" (400 mm)
1 pc	Hacksaw frame	12" with Bi-Metal Blade
17 pcs	1/2" Hex Socket	8, 10, 11, 12, 13, 14, 15, 16, 17, 18, 19, 21, 22, 24, 27, 30, 32 mm
5 pcs	1/2" Hex Socket - Deep	10, 14, 17, 19, 22 mm
1 pc	1/2" Ratchet handle	
1 pc	1/2" Sliding T Bar	
1 pc	1/2" L Handle	
2 pcs	1/2" Universal Joint	
2 pcs	1/2" Extension Bar	5" & 10"
2 pcs	1/2" Spark Plug Socket	16 mm & 21 mm
2 pcs	Socket Adaptors	1/2 F × 3/4 M, 1/2 F × 3/8 M
1 pc	Feeler Gauge	20 leaves, 150 mm
1 pc	Adjustable Wrench	10" (250 mm)
1 pc	Water Pump Plier	10" (250 mm)
1 pc	Locking Plier	10" (250 mm)
1 pc	Rust Preventive Lubricant Spray - GO20	300 gms
1 pc	Retra Knife	
1 pc	5 Tray Cantilever Tool Box	

ORDERING INFORMATION

CAT NR.	BOX QTY.
MTB/5/84/AU	1
MTB/5/64/AU	1



64 pcs tool assortment in metric sizes for use in automotive workshops & service stations

Tool box manufactured from heavy gauge steel sheet

Rugged construction to withstand repeated use in tough conditions



MTB/5/64/AU
64 Piece Mechanic's Tools Kit

	QTY	CONTENTS OF TRAY	SIZE	IMAGE
TRAY 1	19 pcs	1/2" Sockets	8, 10, 11, 12, 13, 14, 15, 16, 17, 18, 19, 21, 22, 24, 26, 27, 28, 30, 32 mm	
	10 pcs	Hexagonal Keys	1.5, 2, 2.5, 3, 4, 5, 5.5, 6, 8, 10 mm	
	1 pc	Self Locking Plier	7" (175 mm)	
TRAY 2	1 pcs	Combination Plier	8" (200 mm)	
	1 pc	Long Nose Plier	8" (200 mm)	
	1 pc	Side Cutting Plier	7" (175 mm)	
TRAY 3	17 pcs	Combination Spanners	6, 7, 8, 9, 10, 11, 12, 13, 14, 15, 16, 17, 18, 19, 20, 21, 22 mm	
	1 pc	Ball Pein Hammer - Wood Handle	16 oz. (453 g)	
	1 pc	1/2" Extension Bar	10" (250 mm)	
	1 pc	1/2" Sliding T-bar	-	
	1 pc	1/2" Universal Joint	-	
TRAY 4	1 pc	Water Pump Plier	10" (250 mm)	
	1 pc	1/2" Ratchet Handle	-	
	1 pc	1/2" Extension Bar	5" (125 mm)	
TRAY 5	6 pcs	Screwdriver	FL4 x 100 mm, FL6 x 100 mm, FL8 x 150 mm, PH1 x 75 mm, PH2 x 100 mm, PH3 x 150 mm	



General purpose cantilever tool box

Manufactured from heavy gauge steel sheet

Corrosion resistant powder coated finish

Full spread cantilever mechanism gives quick & easy access to all stored parts

Trays open automatically when handle is depressed & close when lifted

Lid incorporates provision for padlock

Load Capacity: 35 kg

Also available with 4 wheel trolley made from heavy gauge steel sheet. Heavy duty castors for convenient movement in the workshop/ garage



MTB/5



MTB/5T

Full spread cantilever mechanism



ORDERING INFORMATION

CAT NR.	DESCRIPTION	TOOL BOX DIMENSIONS		BOX QTY.
		(INCH)	(MM)	
MTB/5	Tool Box	17-5/16 x 7-7/8 x 7-7/8	440 x 200 x 200	1
MTB/5T	Tool Box with Trolley			1
BDL/MTB/5	Trolley only			1



The Groz Heavy duty Magnetic Tool Cart Accessories are the most efficient storage method to organize your tools and keep them in perfect order & within reach

NEW!

Powerful N52 Neodymium rare earth magnets stands strong even in the harshest of environments

Suitable for use in garages, basement, offices, workshops industries etc.

Magnetic Can Holder

- Magnetic Can Holder is an easy-access accessory designed for tool carts and cabinets
- Manufactured from steel with powder coated finish to resist corrosion
- Perfect size to securely hold spray cans, spray bottles, grease cartridges, bottles and other cylindrical objects
- Maximum dia. upto 3-11/32" (85 mm)
- 2 powerful N52 neodymium rare earth magnets with a rubber coating prevent scratches on the surface where the holder is attached
- Max. Load Capacity: 10 kg (22 LBS.)



Magnetic Hooks

- Magnetic hooks are designed for secure and versatile hanging, providing a strong hold and easy repositioning on any metal surface
- Super strong Neodymium magnet in centre with a strong ferrite magnet layer on boundary to hold heavy weights upto 10 kg (22 lbs.)
- Extra-large chrome plated hook swivels 360° for multiple hanging positions



Magnetic Power & Air Tools Holder

- Magnetic Power and Air Tool Holder keeps power tools ready for use
- The holder easily attaches to the side wall of the tool trolley using three strong neodymium magnets and securely hook onto the top of the trolley
- 3 powerful N52 neodymium rare earth magnets with a rubber coating prevent scratches on the surface where the holder is attached.
- Three mould configuration securely hold two standard size power tools & one jumbo size power tool



ORDERING INFORMATION

CAT NR.	DESCRIPTION	BOX QTY.
MCH/1	Magnetic Can Holder	10
MHK/1	Magnetic Hook	10
MPT/1	Magnetic Power Tool Holder	5

NEW!

Make a clutter-free & organised workspace with the Groz Foldable Magnetic Pads

The Foldable Magnetic Pad are made with powerful ferrite magnets

Easy to clean vinyl construction prevents damage to finished surfaces

Can be attached to any metal surface in any orientation, including horizontal, vertical, or upside down

Ideal for garages, tool shops, and warehouses, the Magnetic Pad is the perfect addition to any organized workspace.



ORDERING INFORMATION

CAT NR.	SIZE		BOX QTY.
	(INCH)	(MM)	
MPAD/F/8-11	8-1/4 x 11	210 x 280	20
MPAD/F/5-18	5-1/2 x 18	140 x 450	20
MPAD/F/11-19	11 x 19	280 x 480	20

34

Magnetic Tool Holder Heavy Duty

MTH-12

MTH-24

The Groz Heavy duty Magnetic Tool Holder is the most efficient storage method to organize your tools and keep them in perfect order & within reach. Suitable for use in garages, basement, offices, workshops, studios, kitchen surfaces etc.

Super durable ferrite magnets are equally distributed all across the bar for even magnetic impact at every point.

Easy installation on concrete, brick or wooden walls by using standard screws & anchors (included)



MTH-24S



MTH-12S

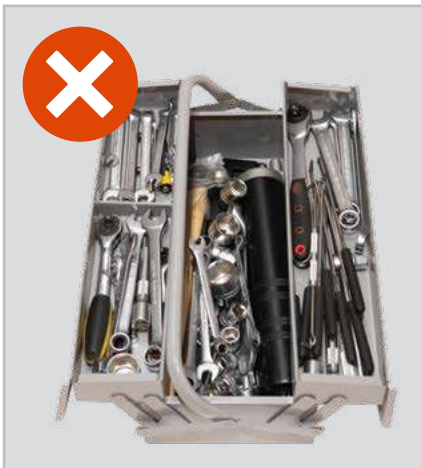

Get rid of your messy tool box



Organize your tools for efficient working

ORDERING INFORMATION

CAT NR.	NO. OF MAGNETS	LOAD CAPACITY		DIMENSION		BOX QTY.
		(KG)	(LBS)	(INCH)	(MM)	
MTH/12S/ST2	5	4.5	10	1×12	26×300	20
MTH/24S/ST2	11	9.0	20	1×24	26×600	20

High Accuracy Torque Wrench with unmatched safety & accuracy

48 teeth ratchet for an engagement angle of 7-1/2°. Ideal for both precise adjustment & non slip use

Chrome-Molybdenum alloy Steel Square Drive

Fully secure locking mechanism avoids accidental/forced adjustment

To tighten move torque wrench in clockwise direction. Reversing the ratchet allows the wrench to be used for loosening nuts & fasteners

Clearly audible click sound on reaching the required torque

Comes with calibration certificate

Fully serviceable, repair kits available as spare

Accurate to ± 4%

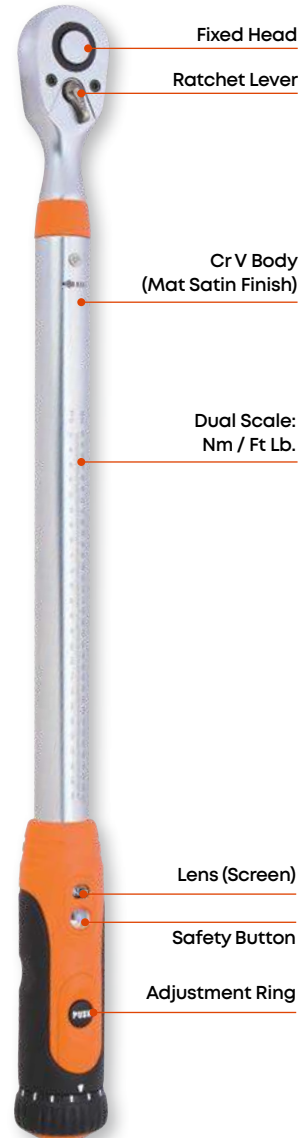

ORDERING INFORMATION

CAT NR.	SQUARE DRIVE	TORQUE RANGE	FINE SCALE	OVERALL LENGTH		NET WT.	BOX QTY.
	(INCH)	(NM)	(NM)	(INCH)	(MM)	(KGS)	
TQW/RT/3-8/25	3/8	5-25	0.1	12.7	323	0.765	1
TQW/RT/3-8/50	3/8	10-50	0.5	15.7	400	0.983	1
TQW/RT/1-2/100	1/2	20-100	0.5	15.7	400	0.998	1
TQW/RT/1-2/200	1/2	40-200	0.5	20.4	517	1.36	1
TQW/RT/1-2/340	1/2	60-340	1	24.4	620	1.73	1
TQW/RT/3-4/750	3/4	150-750	2.5	47.6	1210	5.85	1
TQW/RT/0-1/1000	1	200-1000	2.5	59.0	1500	7.43	1



36

**Torque Wrenches
Cushion Grip**

TQ-10

High Accuracy Torque Wrench with unmatched safety & accuracy

Conforms to DIN 6789 & ASME B107

32 teeth ratchet allows for an engagement angle of 11-1/4°, providing both precise adjustment & non slip use

Chrome-Molybdenum

Alloy Steel Square Drive

To set torque
Pull back locking ring
Turn the handle to the desired value
Release the locking ring
Wrench is set at desired torque & ready for use

Fully secure locking mechanism avoids accidental/forced adjustment

Quick release mechanism for effortless socket change

To tighten fasteners, move torque wrench in clockwise direction.
Reversing the ratchet allows the wrench to be used in anti-clockwise direction, used for loosening nuts & fasteners

Clearly audible click sound on reaching the required torque

Accurate to ± 4% of reading

Each unit is individually serial numbered & includes calibration certificate traceable to International Standards Institute

Fully serviceable, repair kits available as spare

Dual scale

Set Torque value both in Nm & Ft. lb.



ORDERING INFORMATION

CAT NR.	SQUARE DRIVE (INCH)	TORQUE RANGE		FINE SCALE		OVERALL LENGTH (MM)	NET WT. (KGS)	BOX QTY.
		(NM)	(FT. LBS)	(NM)	(FT. LBS)			
TQ/10S/38-140N/G	3/8	20 - 142	20 - 100	1	0.7	450	1.2	1
TQ/10S/12-200N/G	1/2	40 - 200	30 - 150	1	0.7	536	1.54	1
TQ/10S/12-340N/G	1/2	60 - 340	50 - 250	2	1.5	617	1.75	1

Manufactured to the highest level of DIN ISO 6789 & ASME B107.14M.-2004

Solid steel construction for enhanced durability

Reversible Square Drive:
Direction of use can be changed/reversed by pushing the square drive to the opposite side

Click sound clearly audible on reaching the required torque

Convenient retracting lever provides quick and easy torque adjustment

Scale reading made easy with four torque readings engraved on the steel body

Comes with calibration certificate

Accurate to $\pm 4\%$

ASME
B107.300- 2010

DIN 6789
For material, hardness & performance

Compact design
For easy access in confined spaces

Easy scale reading
Scale reading made easy with 4 Torque readings stamped on the steel body

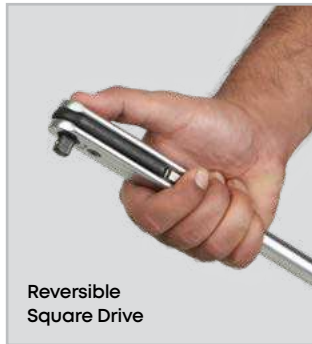

Reversible Square Drive

Convenient Retracting Lever for quick and easy torque adjustment



ORDERING INFORMATION

CAT NR.	SQUARE DRIVE	TORQUE RANGE		OVERALL LENGTH		NET WT. (KGS)	BOX QTY.
	(INCH)	(NM)	(FT-LB)	(INCH)	(MM)		
TQW/CL/3-8/33	3/8	5-33	4-24	16-5/8	422	0.720	1
TQW/CL/3-8/68	3/8	12-68	10-50	18-23/32	476	1.05	1
TQW/CL/1-2/135	1/2	25-135	20-100	21-1/2	546	1.60	1
TQW/CL/1-2/225	1/2	50-225	40-160	23-1/2	597	2.30	1
TQW/CL/1-2/330	1/2	70-330	50-250	32-1/2	825	2.60	1
TQW/CL/3-4/800	3/4	200-800	140-600	42-1/8	1070	7.58	1
TQW/CL/0-1/1000	1	200-1000	140-740	55	1400	12.80	1



Comes packed in a blow moulded case

38

Aluminium Torque Wrenches

TQW-AL

Lightweight yet robust aluminium construction

Perfect ergonomics & lightweight body makes these ideal for fatigue free usage in heavy workshop applications

Accurate $\pm 4\%$

DIN 6789
For material, hardness & performance

50% LIGHTER

ASME B107.300-2010



Complete with extension bar* (*only with 1" drive model) for added leverage

Torque Indication

Progressive torque building upto the pre-set value easily detected by an audible sound & impulse

Sturdy Storage

Supplied in rugged blow moulded case for extra safety and protection

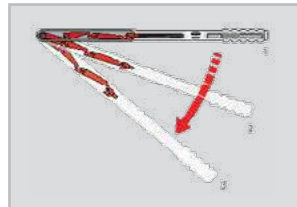

Integrated 3 Lever Chain Mechanism

Length independence, high accuracy and reliability every time over time



Length Independent

Irrespective of where the force is applied, whether in the middle of the handle or elsewhere, with both hands or with an extension tube, the torque value is always within an accuracy of $\pm 3\%$



Dual Scale Window
Clear window for reading in NM and lbf-ft*



Torque Adjustment
Secure push-pull knob with integrated hex key for easy setting of torque



Chrome Molybdenum Square Drive: for higher strength and durability



Added Leverage
Supplied with an aluminium tube extension for increased leverage while tightening at high torque values

ORDERING INFORMATION

CAT NR.	SQ DRIVE	TORQUE RANGE		GRADUATION	OVERALL LENGTH		NET WT. (KG)	BOX QTY.
	(INCH)	(NM)	(FT-LB)		(INCH)	(MM)		
TQW/AL/3-4/760	3/4	140-760	100-560	10	32-1/2	827	3.0	1
TQW/AL/0-1/2000	1	750-2000	550-1470	50	93	2370	11.7	1

*Only on 3/4". On 1" single window with reading in N-m only

Heavy duty torque multiplier provides mechanical advantage in applying high torque to tighten nuts & bolts

Particularly used for high torque application

Chrome Vanadium construction with Chrome Molybdenum square drive & Chrome Molybdenum reaction bar

Planetary gear train mechanism multiplies the input torque as per the multiplication factor to deliver the output torque

Torque multiplicative factor reduces operator effort by upto 75%

Replaces the use of long levers, which can be potentially dangerous

Includes breakaway adaptor to prevent damage to the multiplier in case excess torque is applied

Comes complete with straight reaction bar, breakaway adaptor & hex key in a blow moulded case

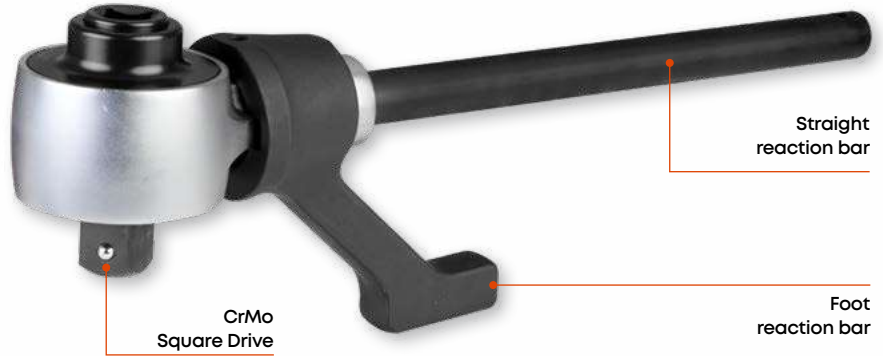

SPECIFICATIONS

DESCRIPTION	1:6.5 TORQUE MULTIPLIER 1500 NM	1:3.3 TORQUE MULTIPLIER 2500 NM
MAX. TORQUE	1500 (1100 ft-lb)	3000 (2200 ft-lb)
TORQUE RATIO	1: 3	1: 3
GEAR RATIO	1: 3.5	1: 3.5
MAX. INPUT TORQUE	500 Nm (365 ft-lb)	1000 Nm (730 ft-lb)
MAX. OUTPUT TORQUE	1500 Nm (1100 ft-lb)	3000 Nm (2200 ft-lb)
INPUT DRIVE	1/2"	3/4"
OUTPUT DRIVE	3/4"	1"
ACCURACY	± 6%	± 6%

ORDERING INFORMATION

CAT NR.	MAX. TORQUE		BOX QTY.
	(NM)	(FT-LB)	
TQM/A/1-2/3-4/15	1500	1100	1
TQM/A/3-4/0-1/30	3000	2200	1



Torque multiplier used in inaccessible areas



Torque multiplier used for lug nuts



Torque multiplier used on tracks



Torque multiplier used for machine nut tightening

40

Torque Extension Bars 10 Piece Kit

TQE
NEW!

The Groz 1/2" drive Torque Extension Bars help mechanics to apply torque to correct tolerance

It prevents over-tightening of wheel lug nuts, distortion of wheels, drums and rotors

Once the maximum torque is reached, the extension flexes to absorb any further force and prevents over-tightening

Both ends are 1/2" drive, making it compatible with sockets and impact wrenches, even those with an extended anvil

Manufactured from durable & resilient powder coated Chrome Molybdenum Steel

Colour-coded bars are engraved with torque range for quick & easy identification

Comes with a blow moulded case or a wall mounting bracket



SPECIFICATIONS

DRIVE SIZE	1/2"
OVERALL LENGTH	7-11/16" (195 mm)

KIT INCLUDES

SR. NR.	TORQUE RANGE	
	FT-LB	NM
1	65	90
2	75	100
3	80	110
4	90	120
5	100	135
6	110	150
7	120	160
8	135	185
9	140	190
10	150	205



ORDERING INFORMATION

CAT NR.	BOX QTY.
TQE/1-2/ST10	1



41

Strap Wrench

STW

Aluminium I-beam handle for increase strength

Non marring nylon belt prevents scratching and damage to finished surfaces

Use on plastic or metal pipes & fittings, filters, shafts and irregular shapes.

Easily replaceable strap with removable rivets



Used on plastic or metal pipes



Used on irregular shaped objects



Removable pin design for quick strap change

Strap

ORDERING INFORMATION

CAT NR.	HANDLE LENGTH		STRAP LENGTH		STRAP WIDTH		FOR OBJECTS WITH DIA.		BOX QTY.
	(INCH)	(MM)	(INCH)	(MM)	(INCH)	(MM)	(INCH)	(MM)	
STW/12G	12	300	36	914	1-1/16	27	7	175	10
STW/18G	18	450	34	864	1-3/4	44	7	175	10

42

Tyre Levers

TLVR

Professional quality straight pattern tyre levers with hook & taper end

Forged from Carbon Steel

Nickel plated for protection against corrosion

Designed to work without damaging the tyre, rim or inner tube



ORDERING INFORMATION

CAT NR.	LENGTH		BOX QTY.
	(INCH)	(MM)	
TLVR/16	16	400	10
TLVR/21	21	530	10
TLVR/24	24	600	10

43

Pocket Pry Bars

MPRY-ST



NEW!

Pocket sized pry bars with multiple use in automotive, electrical & general workshop applications

Manufactured from high tensile 3/16" diameter alloy steel

Black finish prevents corrosion

Polyacetate handle with stainless steel pocket clip

These 5" pocket pry bars are useful for removing seals, electrical connectors, plastic clips, o-rings, plastic caps, interior trim pieces, metal and plastic retainers

Comes as a set of 3

- Straight Pry Bar
- Angled Pry Bar 27°
- Angled Pry Bar 55°



ORDERING INFORMATION

CAT NR.	BOX QTY.
MPRY/3/ST	20

44

13 Pc Automotive Maintenance Tool Kit

MPRY-13ST

NEW!

A must-have kit for interior and boot maintenance application

Handle is made of Chrome Vanadium inner core

5 Prying tools are made of Spring Steel with Chrome Plating

7 Screwdriver bits are made of S2 Steel

Comes in a vinyl pouch with a Velcro closure

1/4" Hex Nut Driver: Easily interchange attachments as per need



	SET INCLUDES	QTY	SIZE	USED FOR
	Tack Lifter	1 pc		For extracting hard-to-remove nails. V-slot chisel tip slips under staples, tacks and brads, loosening them with ease
	Buckle Prying Tool	2 pcs	Small	To remove pins and buttons
			Big	
	Mini Pry Bar	2 pcs	Straight	Useful for removing seals, electrical connectors, plastic clips, O-rings, plastic caps, interior trim pieces, metal and plastic retainers
			Angled	
	Screwdriver Phillip Bit	1 pc	PH2	
	Screwdriver Pozi Bit	1 pc	PZ2	
	Screwdriver Slotted Bit	1 pc	SL5.5	
	Screwdriver Torx Bit	4 pcs	T20	
			T25	
			T27	
			T30	



ORDERING INFORMATION

CAT NR.	BOX QTY.
MPRY/13/ST	20

45

Magnetic Drain Plug Remover Tool

MDR

NEW!

A quick and convenient tool to remove oil drain plugs without touching the hot plug or hot oil.

Just loosen the plug with a socket wrench, then attach the powerful magnet to the drain plug and turn the tool to remove the plug

Strong magnet sticks to the drain plug firmly. Heat resistant magnets do not demagnetize

6" flexible shaft allows the tool to be used in difficult to reach locations and positions while still being capable of threading and unthreading the drain plug. The magnetic head helps in locating the plug securely onto the tool

How to use:

- Loosen the drain plug with a wrench,
- Place the magnet on the plug so the tool locks onto the plug hex.
- Rotate the handle to remove the plug



ORDERING INFORMATION

CAT NR.	BOX QTY.
MDR/6	10

Forged **Chrome Vanadium** jaws with long & short reach options

Heat treated alloy steel cross bolt & head for maximum strength

Rolled spindle threads for higher strength & smooth movement even under high stress

2 Jaw models are useful for working in compact spaces

3 Jaw option ensures equal load distribution to slide gears, pulleys & flywheels off shaft without damage



3 Jaw Puller used for removing tyre hub

ORDERING INFORMATION

CAT NR.	MAX. REACH		SPREAD RANGE		SAFE WORKING LOAD (TON)	BOX QTY.
	(INCH)	(MM)	(INCH)	(MM)		
2 JAW						
BPL/2J/3	3	75	1-7/16	37-75	2	5
* BPL/2J/4	4	100	2 - 4	50-100	4	5
* BPL/2J/6	6	150	3 - 6	75-150	6	5
BPL/2J/8	8	200	4 - 8	100-200	10	1
3 JAW						
BPL/3J/3	3	75	1-7/16	37-75	3	5
* BPL/3J/4	4	100	2 - 4	50-100	6	5
* BPL/3J/6	6	150	3 - 6	75-150	9	1
BPL/3J/8	8	200	4 - 8	100-200	15	1

* Best Seller

47

Quick Change Ratcheting Gear Pullers

BPL-RT



CrMo

Quick & convenient to use Gear Pullers

Speed

- a. Quick & convenient conversion from 2 to 3 jaw option
- b. Jaws can also be reversed for internal or external pulling of gears & bearings

Easy Access

Slim profile of jaws enables convenient access to hard to reach bearings & gears

Anti-slip grip

On the jaws for better grip on the bearing

Strength

Jaws forged from Chrome Molybdenum steel with accurate heat treatment for enhanced strength & wear resistance

Jaws are chrome plated with spindle in manganese phosphate finish for protection against corrosion & rust

Versatility

Easily removable jaws for setting to required jaw configuration or internal/external setting

Ratcheting mechanism holds jaws in position while setting puller

Used to pull out gears, pulleys, bearing flanges & fly wheels, shafts and housings



- ✓ SPEED
- ✓ ACCESS
- ✓ STRENGTH
- ✓ VERSATILITY

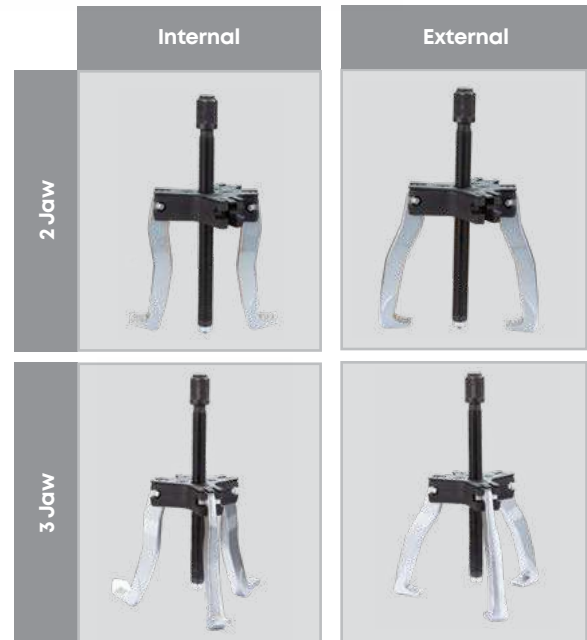

Easy switch between 2 Jaw & 3 Jaw options
No extra tools required.

ORDERING INFORMATION

CAT NR.	MAX. REACH		SPREAD		SAFE WORKING LOAD (TON)	BOX QTY.
	(INCH)	(MM)	(INCH)	(MM)		
BPL/RT/2T	3.1	80	2.0 - 3.1	50 - 80	2	1
* BPL/RT/5T	6.0	150	3.9 - 6.0	100 - 150	5	1
BPL/RT/7T	8.6	218	4.9 - 8.6	125 - 218	7	1

* Best Seller



SCAN TO WATCH

Leak-Proof Performance

Welded construction ensures leak proof performance

Higher Stability

Forged steel base plate for higher stability even under high load as compared to jacks with CI base plates

Increased Durability

Internally machined oil passages, smooth bearing surfaces and close tolerances

Machined and polished RAM with die cut threads that reduce wear and tear

Stronger Grip

Knurled heat treated saddle head with non-slip surface gives stronger grip

100% factory tested

50% safety overload factor

In-built 'Load Limiting Device'

Unique safety feature to ensure that jack is not accidentally used beyond rated capacity

Ideal for use on heavy duty trucks, in agriculture, construction, mining, automotive, and marine applications where lifting, pushing, spreading, bending, pressing, or straightening is required



CAT NR.	JACK/BT/2W		JACK/BT/4W		JACK/BT/12W	
CAPACITY	2 TON	1815 KG	4 TON	3629 KG	12 TON	10886 KG
LIFT RANGE	175 to 339 mm	7 to 13-11/32 inch	190-368 mm	7 7/16 to 14-13/16 inch	230-465 mm	9-1/16 to 18-5/16 inch
APPLICATION	Passenger Cars, Taxi's etc.		Passenger Cars, Pick-Up Trucks, SUV's, MUV's, Vans, LCV's		HCV, Trucks (9-24 ton), Buses	
BOX QTY	1		1		1	
CAT NR.	*JACK/BT/20W		JACK/BT/32W		JACK/BT/50W	
CAPACITY	20 TON	18144 KG	32 TON	29030 KG	50 TON	45359 KG
LIFT RANGE	240-450 mm	9-7/16 to 17-11/16 inch	260-420 mm	10-5/16 to 16-9/16 inch	280-450 mm	11 to 17-11/16 inch
APPLICATION	HCV, Trucks (24-40 TON)		Trailers, Dumpers (40-60 TON)		Dumpers (60-120 TON)	
BOX QTY	1		1		1	

* Best Seller

49

Hydraulic Floor Jack 3 Ton

JACK-FL



Construction

Heavy duty steel body for ultimate stability and rigidity

Large, swivelling saddle for convenient positioning. Rubber cushioning on saddle prevents damage to vehicle lift points

Nylon wheels for easy manoeuvrability and positioning

Safety

Universal joint release mechanism for safe and controlled lowering of the jack

Built-in safety valve protects against overloading of jack @ 120% of rated capacity

Hydraulic oil by-pass system protects ram from being over extended

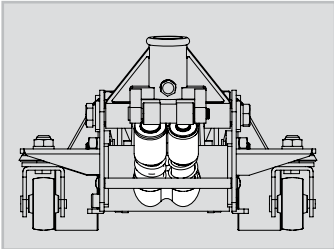

Quick Start Dual Pump Technology At each stroke before reaching the jacking point, the GROZ Quick Start Hydraulic Floor Jack moves up 3 times more than the standard jack

Quick START

3X FASTER Fast lifting design for quick jumpstart to reach 'lifting point'



Comparing the GROZ quick start hydraulic floor jack with a standard floor jack in the market

AT STROKE 0

AFTER 1ST STROKE

AFTER 6TH STROKE



After the 1st stroke, The GROZ Quick Start Hydraulic Floor Jack moves up 3 times more than the standard jack

In 6 strokes, the GROZ Hydraulic Floor Jack reaches lifting point whereas the standard Floor Jack is still way behind

ORDERING INFORMATION

CAT NR.	DIMENSIONS		BOX QTY.
	(INCH)	(MM)	
JACK/FL/3D	27x 13-1/2x 6-1/8	682x344x155	1



SCAN TO WATCH

Hexagonal keys are most widely used in automotive workshops, garages & in several industrial applications

GROZ offers a wide range of hex key sets for use by mechanic's and technicians worldwide

These are available in two material types:

S2 STEEL:

Superior S2 steel construction. Hardened and tempered with corrosion resistant bright nickel plating

Hardness: 50-52 HRC

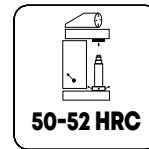

ALN/HX-BL/7L/GRZ

Box Qty: 10

7 Hex Keys With Ball End - Long - Metric

Chamfered hex end for convenience in usage

Ball end permits easy access in tight, hard to reach spaces - upto 30° angle in recess from the screw head



HEX (MM)	L1 (MM)	L2 (MM)
2.5	20	86
3.0	22	91
4.0	27	103
5.0	32	118
6.0	37	139
8.0	43	155
10.0	49	177

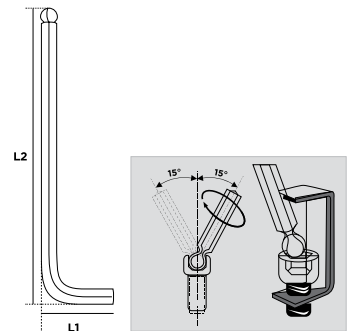

ALN/HX-BL/7L/SAE/GRZ

Box Qty: 10

7 Hex Keys with Ball End - Long - SAE

Chamfered hex end for convenience in usage

Ball end permits easy access in tight, hard to reach spaces - upto 30° angle in recess from the screw head



HEX (INCH)	L1 (INCH)	L2 (INCH)
3/32	5/8	2-1/64
1/8	45/64	2-13/64
5/32	53/64	2-33/64
3/16	15/16	2-3/4
1/4	1-1/16	3-3/16
5/16	1-17/64	3-47/64
3/8	1-11/32	4-1/4

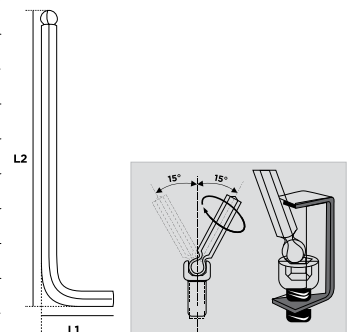

ALN/HX-BL/9EL/GRZ

Box Qty: 10

9 Hex Keys with Ball End - Extra Long - Metric

Chamfered hex end for convenience in usage

Ball end permits easy access in tight, hard to reach spaces - upto 30° angle in recess from the screw head

Extra long arm for easy access in confined spaces



HEX (MM)	L1 (MM)	L2 (MM)
1.5	15	91
2.0	17	101
2.5	20	113
3.0	22	127
4.0	27	142
5.0	32	163
6.0	37	184
8.0	43	205
10.0	49	233

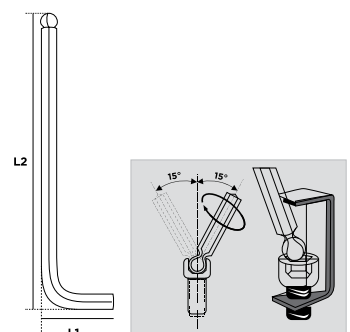

ALN/TX-TX/9L/GRZ

Box Qty: 10

9 Torx Star Keys - Long

Compatible with standard TORX fixing systems



TORX	L1	L2
	(MM)	(MM)
T10	18	86
T15	20	90
T20	20.5	94
T25	20.5	100
T27	21	105
T30	24	114
T40	26.5	123.5
T45	29.5	132.5
T50	32.5	151

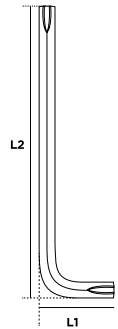

CHROME VANADIUM:

Hardened & tempered with corrosion resistant black oxide finish

Hardness: 50-52 HRC

DIN 896



ALN/HX-HX/8/GRZ

Box Qty: 10

8 Hexagonal Keys - Metric



HEX (MM)	L1 (MM)	L2 (MM)
1.5	14	45
2	15	48
2.5	16	51
3	18	56
4	21	64
5	24	70
5.5	26	75
6	27	81

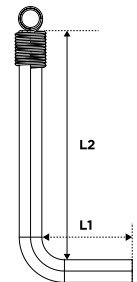

ALN/HX-HX/10/GRZ

Box Qty: 10

10 Hexagonal Keys - Metric



HEX (MM)	L1 (MM)	L2 (MM)
1.5 mm	14	45
2 mm	15	48
2.5 mm	16	51
3 mm	18	56
4 mm	21	64
5 mm	24	70
5.5 mm	26	75
6 mm	27	81
8 mm	32	95
10 mm	34	108

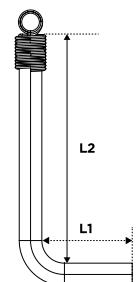

ALN/HX-HX/10/SAE/GRZ

Box Qty: 10

10 Hexagonal Keys - SAE



HEX (INCH)	L1 (INCH)	L2 (INCH)
1/16	35/64	1-49/64
5/64	19/32	1-57/64
3/32	5/8	2-1/64
1/8	45/64	2-13/64
5/32	53/64	2-33/64
3/16	15/16	2-3/4
7/32	1-1/32	2-61/64
1/4	1-1/16	3-3/16
5/16	1-17/64	3-47/64
3/8	1-11/32	4-1/4

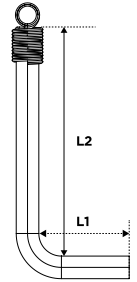

ALN/HX-HX/25/GRZ

Box Qty: 10

25 Hexagonal Keys - Metric & SAE

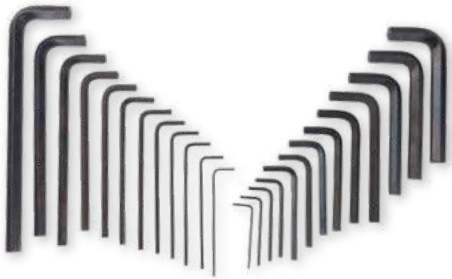

HEX (MM)	L1 (MM)	L2 (MM)
METRIC		
1.5	14	45
2	15	48
2.5	16	51
3	18	56
4	21	64
4.5	23	67
5	24	70
5.5	26	75
6	27	81
7	30	88
8	32	95
9	34	102
10	34	108

HEX (INCH)	L1 (INCH)	L2 (INCH)
SAE		
1/16	35/64	2-7/16
5/64	5/8	3
3/32	45/64	3-11/32
7/64	3/4	3-15/32
1/8	25/32	3-35/64
9/64	55/64	3-47/64
5/32	63/64	3-15/16
3/16	1-7/64	4-1/2
7/32	1-3/16	5
1/4	1-17/64	5-5/16
5/16	1-27/64	6
3/8	1-37/64	6-2/3

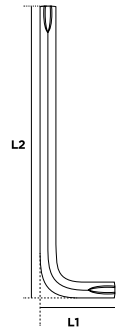

ALN/HX-HX/7/GRZ

Box Qty: 10

7 Hexagonal Keys - Metric

Chamfered end for convenience in usage



HEX (MM)	LENGTH (MM)
2.5 mm	55
3 mm	60
4 mm	65
5 mm	70
6 mm	80
8 mm	85
10 mm	90

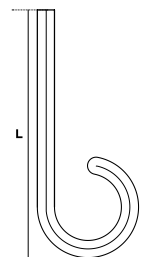

ALN/TX-TX/8/GRZ

Box Qty: 10

8 Tamper Torx Star Keys

Chamfered end for convenience in usage

Compatible with standard TORX fixing systems



TAMPER TORX	LENGTH (MM)
T9	58
T10	62
T15	70
T20	72
T25	79
T27	88
T30	91
T40	95

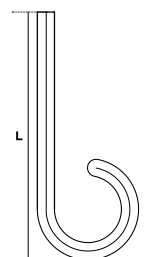

51

7 pc Insulation Screwdrivers Set

SCDR-VDE



Certified to IEC 60900

Individually forged from Chrome Vanadium Steel, blades are fully hardened & tempered for increased durability & strength

Magnetized tip to hold screws

Bi-material ergonomic handle is impact and abrasion resistant

1000V SAFE

Each tool is tested for dielectric strength under a 10000 volt load to guarantee safe working upto 1000 Volts

Ideal choice for electricians for use on terminal blocks, control cabinets, switches, relays, sockets etc.



SET INCLUDES

TYPE	SIZE		SHAFT LENGTH	
	(MM)	(INCH)	(MM)	INCH
SLOTTED				
	6.5	1/4	150	6
	5.5	7/32	125	5
	4	5/32	100	4
	3	1/8	100	4
PHILIPS				
	PH1		80	3-1/8
	PH2		100	4
VOLTAGE TESTER				
110V - 230V Single Pole Voltage Tester				

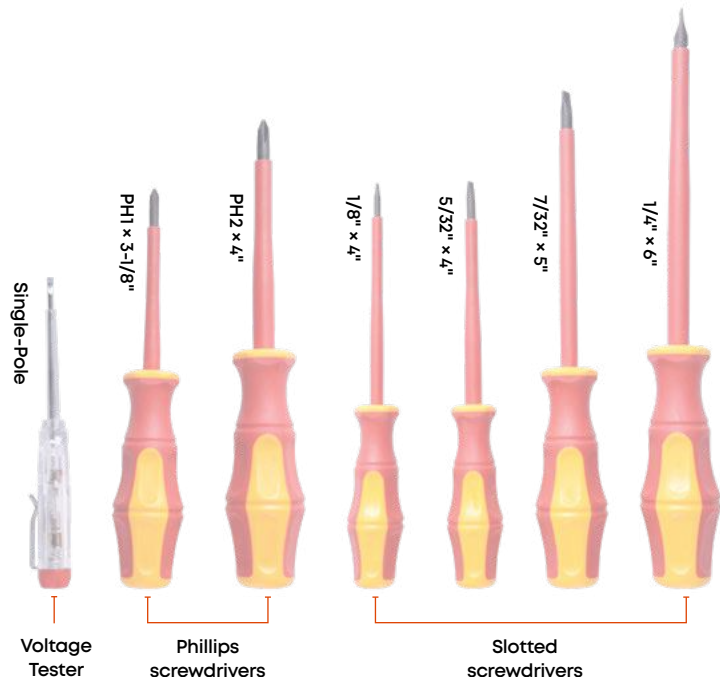

Voltage Tester

Phillips screwdrivers

Slotted screwdrivers

SCDR/VDE/7/ST

ORDERING INFORMATION

CAT NR.	BOX QTY.
SCDR/VDE/7/ST	5
VT/110-250	20



Designed for high torque applications with outstanding performance & durability

72 teeth, strong gear ratcheting ring with 5° arc for smooth movement

Ratcheting mechanism for increased working speed, eliminating the need to remove the spanner after each turn

Narrow and thin head, combined with fine gear tooth design makes the Ratcheting Spanner suitable for working in tight and hard to access areas

Reversible lever to change direction

15° offset at ring end for easy access to fasteners and higher leverage

Chrome plated for corrosion protection with ultra premium finish for scratch proof surface



72 Teeth with 5° action arc:
Provide extreme high torque for professional users

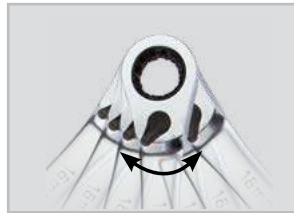

Reversible Lever:
Makes it easy to switch direction

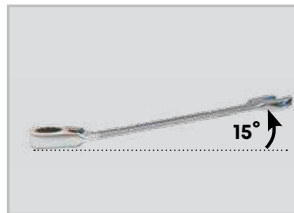

Higher Accessibility:
Offset at the ring end with 15° angle for easier access & higher leverage



Reversible Lever

72 Teeth Ratchet

Bi-Hex profile:
Grips the fastener better

ORDERING INFORMATION

CAT NR.	SIZE	LENGTH		WEIGHT (GMS)	BOX QTY.
	(MM)	(INCH)	(MM)		
CSP/RRT/8/UG	8	5-1/2	140	40	5
CSP/RRT/10/UG	10	6-5/16	160	55	5
CSP/RRT/12/UG	12	6-11/16	170	80	5
CSP/RRT/13/UG	13	7-3/32	180	95	5
CSP/RRT/14/UG	14	7-1/2	190	110	5
CSP/RRT/17/UG	17	9	225	180	5
CSP/RRT/19/UG	19	9-5/8	245	235	5
SET					
CSS/RRT/7ST/UG	7 pc set: 8, 10, 12, 13, 14, 17, 19 mm				1



CSS/RRT/7ST/UG

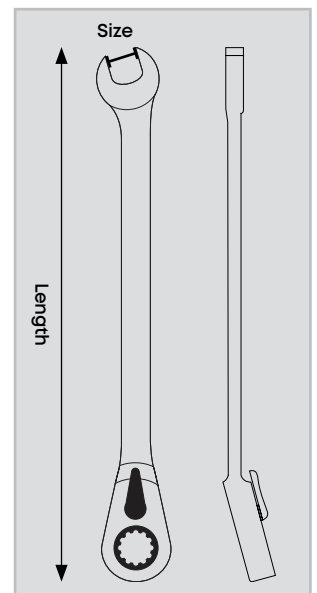

53

Ring Spanners

RSP



DIN 838

Ring spanners have an elliptical pattern & are cold stamped from chrome vanadium (31CrV3) steel

Conforms to DIN 838

Spanners feature super drive broach reducing corner rounding & applying more torque

Fully heat treated to 42-48 HRC for increased work life

Rust proof matte finish

Size laser etched on both ends for easy identification

Available as loose or in sets in metric sizes



RSS/SF/12/ST

ORDERING INFORMATION

CAT NR.	SIZE	LENGTH		SHANK THICKNESS	WEIGHT	BOX QTY.
	(MM)	(INCH)	(MM)	(MM)	(GMS)	
* RSP/SF/6-7/S	6 x 7	6 - 7/8	175	4.4	55	10
* RSP/SF/8-9/S	8 x 9	7 - 9/32	185	4.5	70	10
* RSP/SF/10-11/S	10 x 11	7 - 13/16	198	5.2	90	10
* RSP/SF/12-13/S	12 x 13	8 - 7/16	215	5.4	115	10
* RSP/SF/14-15/S	14 x 15	9	228	5.6	150	10
* RSP/SF/16-17/S	16 x 17	9 - 11/16	246	6.2	190	10
* RSP/SF/18-19/S	18 x 19	10 - 9/16	268	6.4	235	10
* RSP/SF/20-22/S	20 x 22	11 - 1/2	292	6.9	315	5
RSP/SF/21-23/S	21 x 23	12 - 13/32	315	7.1	350	5
RSP/SF/24-27/S	24 x 27	13	328	7.6	450	5
RSP/SF/25-28/S	25 x 28	13 - 7/16	342	7.8	500	3
RSP/SF/30-32/S	30 x 32	14 - 9/16	370	8.8	630	2

SETS		
RSS/SF/12/ST	12 pc Metric Set, 6 x 7, 8 x 9, 10 x 11, 12 x 13, 14 x 15, 16 x 17, 18 x 19, 20 x 22, 21 x 23, 24 x 27, 25 x 28, 30 x 32 mm	5

* Best Seller

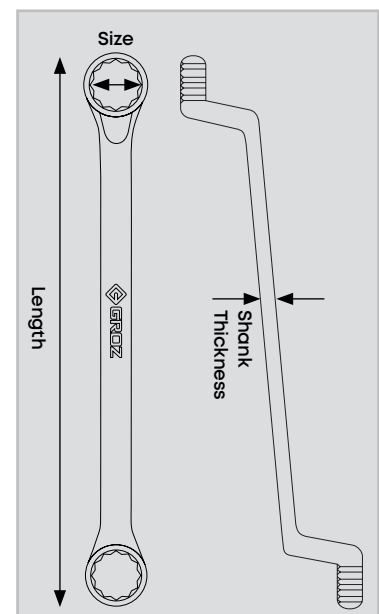



DIN 3110

Conforms to DIN 3110

Cold stamped from chrome vanadium 31 CRV3 Steel

Fully heat treated to 44-48 HRC for increased work life

Elliptical pattern spanners

Rust proof matte finish

Size laser etched on both ends for easy identification

Available as loose or in sets in metric sizes



DOSS/SF/12/ST



ORDERING INFORMATION

CAT NR.	SIZE	LENGTH		SHANK THICKNESS (MM)	WEIG HT (GMS)	BOX QTY.
	(MM)	INCH	(MM)			
* DOSP/SF/6-7/S	6 × 7	5	126	2.60	25	10
* DOSP/SF/8-9/S	8 × 9	5 - 19/32	142	2.60	35	10
* DOSP/SF/10-11/S	10 × 11	6 - 3/16	157	3	50	10
* DOSP/SF/12-13/S	12 × 13	6 - 11/16	170	3.3	70	10
* DOSP/SF/14-15/S	14 × 15	7 - 3/8	187	3.6	95	10
* DOSP/SF/16-17/S	16 × 17	8	202	4	120	10
* DOSP/SF/18-19/S	18 × 19	8 - 21/32	220	4	170	10
* DOSP/SF/20-22/S	20 × 22	9 - 1/8	232	4.4	210	10
DOSP/SF/21-23/S	21 × 23	9 - 11/16	246	4.9	250	10
DOSP/SF/24-27/S	24 × 27	10 - 7/16	265	5.3	330	10
DOSP/SF/25-28/S	25 × 28	10 - 27/32	275	5.8	380	10
DOSP/SF/30-32/S	30 × 32	11 - 23/32	298	6.2	480	10
SETS						
DOSS/SF/12/ST	12 pc Metric Set, 6 × 7, 8 × 9, 10 × 11, 12 × 13, 14 × 15, 16 × 17, 18 × 19, 20 × 22, 21 × 23, 24 × 27, 25 × 28, 30 × 32 mm					5

* Best Seller

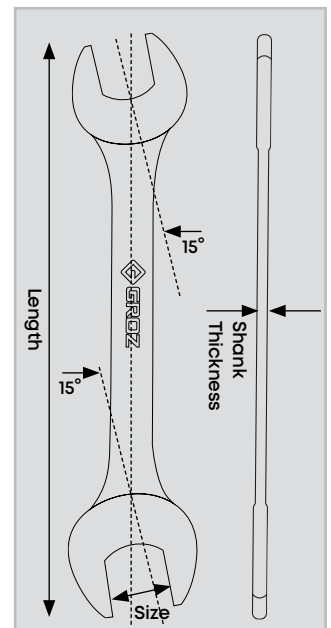

55

Insulation Pliers

CPL-CV

LNP-CV

SCP-CV



Forged Chrome Vanadium steel, fully hardened & tempered

1000V Safe

Tested in accordance with VDE standards & insulated to 1000V AC for live wire working

Heavily insulated, dual colour, ergonomically designed TPR grip is shock-proof & anti-slip making these pliers safest in use

Available in the following types

a. Combination Pliers

Most suitable for gripping, bending, straightening, crushing, pulling, stripping insulation, cutting wires etc

b. Long Nose Pliers

Most suitable for cutting & gripping wires

c. Side Cutting Pliers

Most suitable for cutting wires

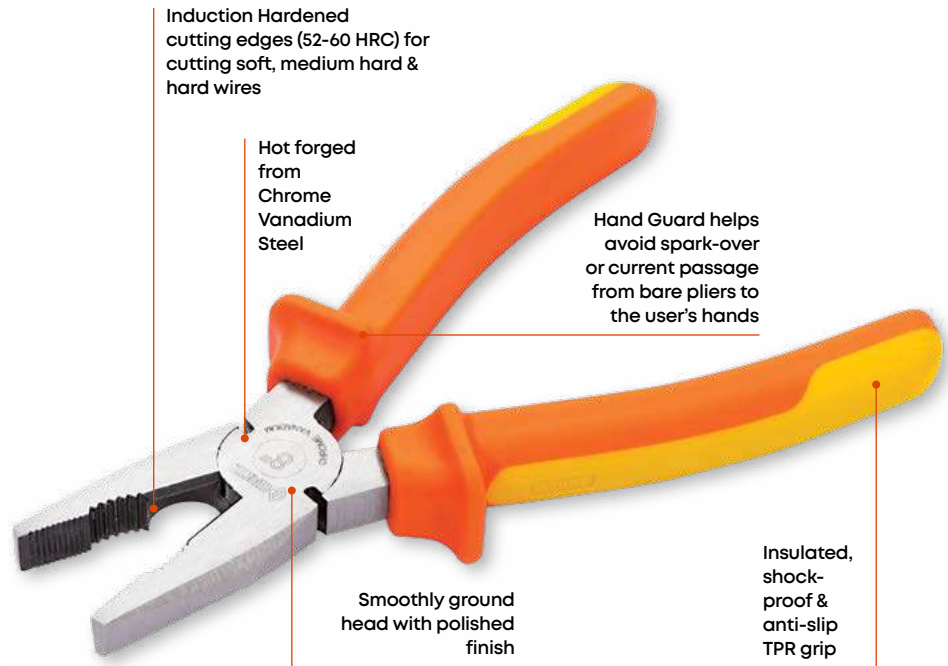

Combination Pliers



Long Nose Pliers



Side Cutting Pliers

ORDERING INFORMATION

CAT NR.	LENGTH		BOX QTY.
	(INCH)	(MM)	
COMBINATION PLIERS			
CPL/CV/6#1	6	150	72
CPL/CV/7#1	7	175	72
*CPL/CV/8#1	8	200	54
LONG NOSE PLIERS			
*LNP/CV/6 #1	6	150	72
LNP/CV/7 #1	7	175	72
*LNP/CV/8 #1	8	200	72
SIDE CUTTING PLIERS			
*SCP/CV/6 #1	6	150	72
SCP/CV/7 #1	7	175	72

* Best Seller

FOR USE WITH



SOFT



MEDIUM HARD



HARD



56

Circlip Pliers

CLP-CV



Precise & solid contact tips prevent circlip damage

Soft cushion grip for comfort in use

Fully hardened & tempered



External Straight



External Bent



Internal Straight



Internal Bent

ORDERING INFORMATION

CAT NR.	DESCRIPTION	LENGTH		BOX QTY.
		(INCH)	(MM)	
CLP/ST/E/150	External Straight	6	150	54
CLP/ST/E/175	External Straight	7	175	54
CLP/ST/I/150	Internal Straight	6	150	54
CLP/ST/I/175	Internal Straight	7	175	54
CLP/BND/E/150	External Bent	6	150	54
CLP/BND/E/175	External Bent	7	175	54
CLP/BND/I/150	Internal Bent	6	150	54
CLP/BND/I/175	Internal Bent	7	175	54

57

Adjustable Wrenches

AWR



Adjustable Wrench is a spanner with a jaw of adjustable width. This allows the same wrench to be used with varying sizes of nuts & bolts unlike conventional fixed spanners

The same wrench can be used with both metric & imperial fasteners

Precision ground jaws for secure grip on fasteners

Ergonomic handle for comfortable grip reducing user fatigue

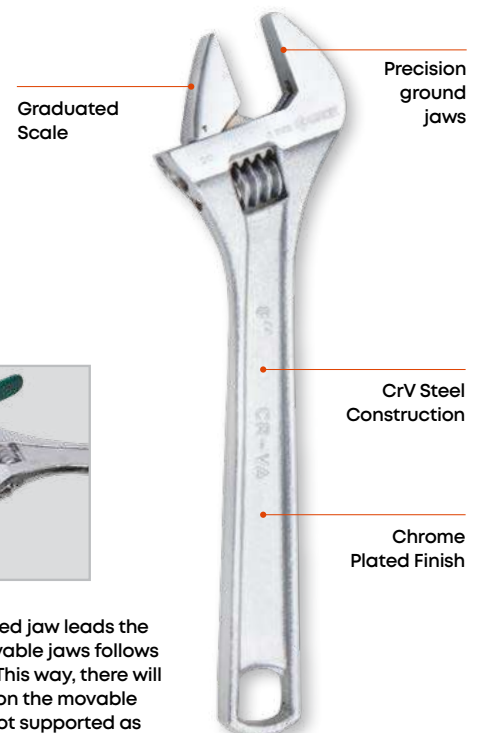

NOTE
Ensure that fixed jaw leads the rotation & movable jaws follows the fixed jaw. This way, there will be less stress on the movable jaw which is not supported as rigidly as the fixed jaw

ORDERING INFORMATION

CAT NR.	LENGTH		OPENING		TORQUE (KGF-M)	BOX QTY.
	(INCH)	(MM)	(INCH)	(MM)		
◆ AWR/CV/6	6	150	3/4	19	148	12
AWR/CV/8	8	200	15/16	24	148	10
★ AWR/CV/10	10	250	1	27	245	10
★ AWR/CV/12	12	300	1-5/16	34	392	10

★ Best Seller ◆ New

58

Telescopic Wheel Wrench

WW-TP

Extending wheel nut wrench is designed to loosen out and remove most rusted wheel nuts

Telescopic handle extends from 14" (350 mm) to 22" (550 mm) giving extra leverage for ease of use

Manufactured from alloy steel, with premium powder coated finish. Fitted with TPR handle for comfort in use

Comes with two 1/2" square drive dual side sockets; 17 x 19 mm & 21 x 23 mm to cover almost every automotive application



Two dual side sockets
17 x 19 mm & 21 x 23 mm



1/2" Square drive in the center of the socket permits use of both hex sides

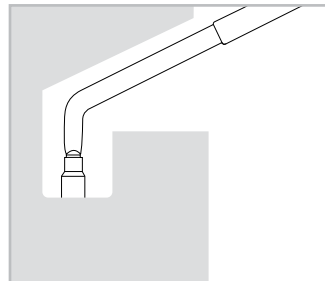

Convenient access in difficult to reach areas

ORDERING INFORMATION

CAT NR.	LENGTH-COMPACT (L1)		LENGTH-EXTENDED (L2)		BOX QTY.
	(INCH)	(MM)	(INCH)	(MM)	
WW/TP/17-23/ST	14-2/5	365	20-3/5	527	12



Extra heavy duty, industrial quality tap wrenches

Straight handle design of these tap wrenches provides greater leverage, particularly useful when working with large diameter taps.

Nr. 0, 5 & 6 have a forged body

Nr. 00, 7 & 8 have die cast body



ORDERING INFORMATION

CAT NR.	LENGTH		JAW HOLDING CAPACITY				BOX QTY.
			SQUARE SIZE		TAP SIZE		
	(INCH)	(MM)	(INCH)	(MM)	(INCH)	(MM)	
ARWR/SG/0	8	200	3/32-1/2	2.5-12	1/8-3/8	M1-M12	20
ARWR/SG/00	5.11/32	133	5/64-9/32	2-7.35	1/8-1/4	M1-M6	20
ARWR/SG/5	10.8	270	11/64-9/16	4.25-14.4	3/16-5/8	M4-M16	10
ARWR/SG/6	14.8	370	11/64-11/16	4.25-17.7	3/16-7/8	M4-M20	10
ARWR/SG/7	19.6	490	1/4-29/32	6.8-23.35	1/4-1.1/8	M6-M30	10
ARWR/SG/8	29.6	740	3/8-1.13/32	9.2-36.0	1/2-1.3/4	M9-M45	5



Rectangular section of the tubular bow ensures perfect combination of rigidity and balance

Aluminium die cast handle, unbreakable in normal use provides comfortable grip and directs pressure in the correct line of thrust for maximum efficiency

Blade can also be set for sawing at 90°. Storage compartment in the tubular

bow for storing spare blades

Lightweight design makes it very useful for overhead cutting or use from a ladder or scaffolding.



ORDERING INFORMATION

CAT NR.	OVERALL LENGTH (L)		HEIGHT (H)		DEPTH OF BOW (H)		BOX QTY.
	(INCH)	(MM)	(INCH)	(MM)	(INCH)	(MM)	
HF15/BS	17	430	5.1/8	130	4.15/64	106	12

Adjustable for 10"(250mm) & 12"(300mm) blade

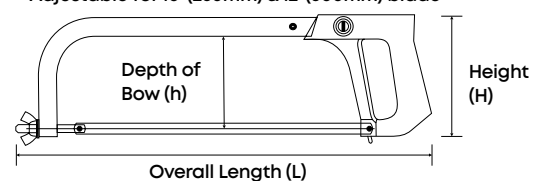

61

Super Cut Hi-Tension Hacksaw

HF40

Rugged aluminum die cast handle & tubular steel frame

Blade can be tensioned to achieve 30,000 PSI, giving a super fast cutting action
Blade can be mounted at 45° for flush cutting jobs

Storage space in the frame for spare blades
Comes complete with 12" (300 mm) Bi-metal blade



ORDERING INFORMATION

CAT NR.	OVERALL LENGTH (L)		HEIGHT (H)		DEPTH OF BOW (H)		BOX QTY.
	(INCH)	(MM)	(INCH)	(MM)	(INCH)	(MM)	
HF/40/BL	16-23/32	425	6-1/2	165	4	100	20

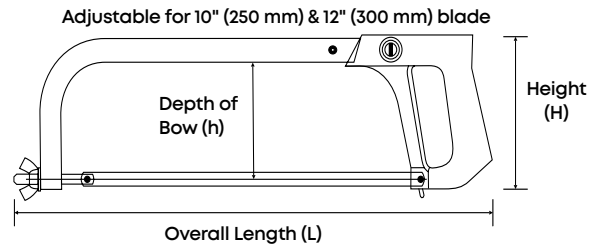
62

Hacksaw Frame Professional

HF12

Rugged heavy duty industrial quality hacksaw frame designed for the professional with guarded grip design

Strong aluminium die cast handle for comfort & control

Easy to use blade tensioning device to set the blade correctly

Supplied complete with 12" chrome alloy steel blade

HF/12/RB

ORDERING INFORMATION

CAT NR.	DETAILS	OVERALL LENGTH (L)		HEIGHT (H)		DEPTH OF BOW (H)		BOX QTY.
		(INCH)	(MM)	(INCH)	(MM)	(INCH)	(MM)	
HF/12/RB	Black frame with red handle	17-5/16	440	5-1/8	130	4	103	10

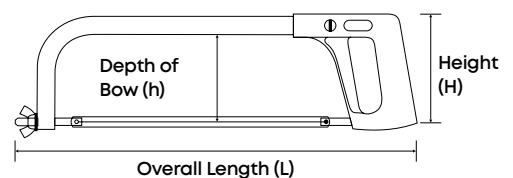

63

G Clamps General Purpose

GCL-13D

SG iron construction with a tensile strength of over 60,000 PSI

Handle is designed to bend before the frame is overstressed

Steel main screw has ACME threads for smooth operation

Swivelling pad adopts the correct

angle and applies even pressure on the work piece

Textured powder coated finish with spindle in black oxide finish for increased resistance to corrosion

Useful for a variety of metal and woodworking applications



ORDERING INFORMATION

CAT NR.	CAPACITY (C)		THROAT DEPTH (D)		FRAME PROOF LOAD (KGS)	BOX QTY.
	(INCH)	(MM)	(INCH)	(MM)		
GCL/13D/50	2	50	1.5/8	42	363	20
GCL/13D/75	3	75	1.11/16	44	455	20
* GCL/13D/100	4	100	2.11/32	59	545	20
* GCL/13D/150	6	150	3	75	635	15
GCL/13D/200	8	200	3.1/8	80	775	8
GCL/13D/250	10	250	3.1/2	90	1000	8
GCL/13D/300	12	300	4	100	1135	8

* Best Seller

64

Mechanic's Vices / Bench Vices

BV

Rigid & robust cast vices with excellent shock bearing capacity and high strength under compression

Fully machined front jaw
Unbreakable SG Iron nut ensures maximum thread surface contact and constant alignment between body and the sliding jaw

Jaws hardened 45±5 HRC for increased resistance to wear

Vice body has an attractive powder coated finish with main screw and handle chrome plated.



ORDERING INFORMATION

CAT NR.	JAW WIDTH		JAW OPENING		THROAT DEPTH		NET WT. (KG)	BOX QTY.
	(INCH)	(MM)	(INCH)	(MM)	(INCH)	(MM)		
BV/F/75	3	75	4	100	2	50	5.50	4
* BV/F/100	4	100	5	125	2.5/32	55	9.70	3
BV/F/125	5	125	6	150	2.3/4	70	14.70	2
* BV/F/150	6	150	7	175	3.5/32	80	18.20	1
BV/F/200	8	200	8	200	4	100	30.40	1

* Best Seller

65

Multi Purpose Vice

BV-MP



Truly versatile multi-purpose vice, ideal for use both by mechanic's and professionals alike

SG iron movable jaw and slide accurately machined for smooth and reliable clamping

Jaws hardened 50±5 HRC for increased resistance to wear

Knurling on jaws ensures firm grip on the work piece

Integrated 360° swivel base with four point mounting for convenient usage in confined spaces or in applications where the angle of the vice has to be changed frequently

Rotating jaw head allows the selection of either a standard parallel serrated jaw or pipe jaws with an integral V-jaw assembly depending on the work in hand

Pipe Jaw can hold pipes with diameter upto 2" (50 mm)

Jaw head can be pivoted 180° either sides and locked in position giving the user complete flexibility to adjust vice to any required working angle with ease

Knurling on jaw Hardened to 50 ±5 HRC



Pipe Jaw can hold pipes with diameter upto 2" (50 mm)



Integrated 360° swivel base



Rotating jaw head

ORDERING INFORMATION

CAT NR.	ORD NR.	JAW WIDTH		JAW OPENING		THROAT DEPTH		NET WEIGHT		BOX QTY.
		(INCH)	(MM)	(INCH)	(MM)	(INCH)	(MM)	(KG)	(LB)	
BV/MP/125	35477	5	125	5	125	2-3/4	70	15.50	34	1



PROFESSIONAL QUALITY SOCKETS

Designed & manufactured
to the highest standards
for use in industrial &
automotive workshops

66

Hand Sockets

3/8" DRIVE

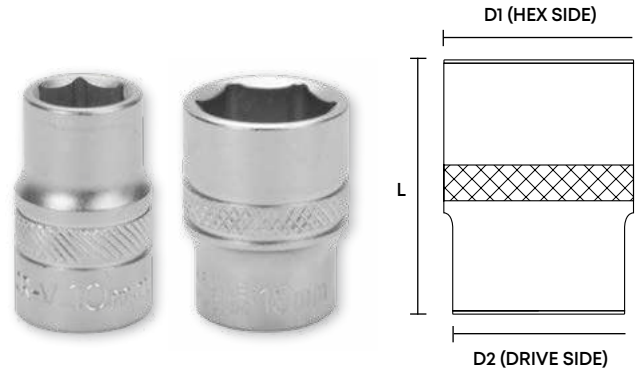

ORDERING INFORMATION

CAT NR.	SIZE	L	D1	D2	BOX QTY.
	(MM)	(MM)	(MM)	(MM)	

HEX SOCKETS

SKT/H/3-8/6/UG	6	28	10.20	16.9	15
SKT/H/3-8/7/UG	7	28	10.60	16.9	15
★ SKT/H/3-8/8/UG	8	28	11.80	16.9	15
SKT/H/3-8/9/UG	9	28	13.20	16.9	15
★ SKT/H/3-8/10/UG	10	28	14.50	16.9	15
SKT/H/3-8/11/UG	11	28	15.70	16.9	15
★ SKT/H/3-8/12/UG	12	28	16.90	16	15
★ SKT/H/3-8/13/UG	13	28	17.90	16.5	15
★ SKT/H/3-8/14/UG	14	28	19.70	17	15
SKT/H/3-8/15/UG	15	28	20.90	18	12
SKT/H/3-8/16/UG	16	30	21.90	19	12
★ SKT/H/3-8/17/UG	17	30	23.45	20	10
SKT/H/3-8/18/UG	18	30	24.65	21	10
★ SKT/H/3-8/19/UG	19	30	25.85	23	10
SKT/H/3-8/20/UG	20	32	27.15	24	8
SKT/H/3-8/21/UG	21	32	27.85	25	8
SKT/H/3-8/22/UG	22	32	29.65	26	6



★ Best Seller



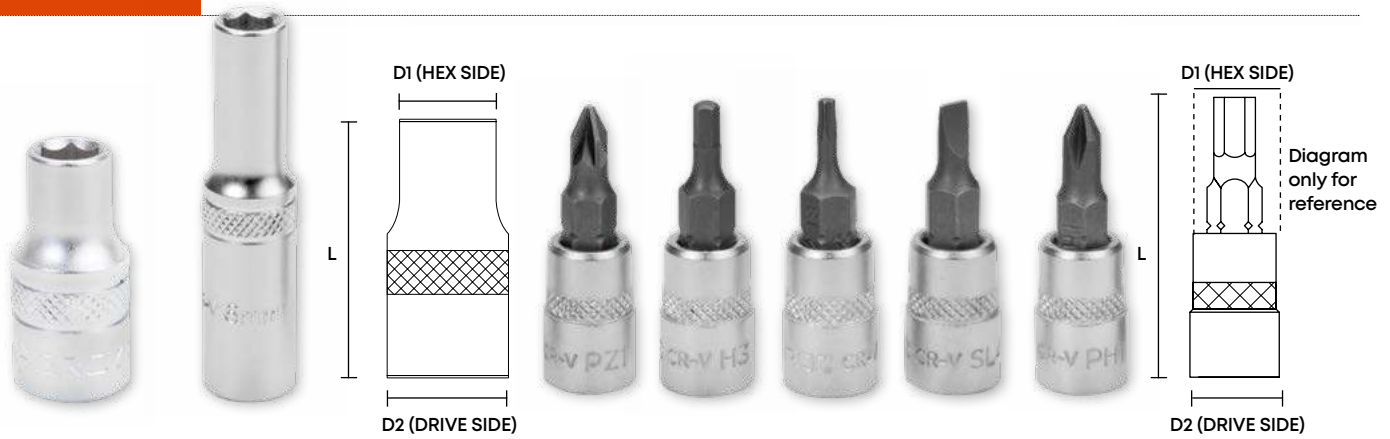



1/4" DRIVE



ORDERING INFORMATION

CAT NR.	SIZE	L (MM)	D1 (MM)	D2 (MM)	BOX QTY.
	(MM)				
HEX SOCKETS 					
SKT/H/1-4/4/UG	4	25	6.80	4	10
SKT/H/1-4/4.5/UG	4.5	25	7.10	4.5	10
SKT/H/1-4/5/UG	5	25	8.00	5	10
SKT/H/1-4/5.5/UG	5.5	25	8.30	5.5	10
SKT/H/1-4/6/UG	6	25	9.30	6	10
SKT/H/1-4/7/UG	7	25	10.50	7	10
SKT/H/1-4/8/UG	8	25	11.85	8	10
SKT/H/1-4/9/UG	9	25	12.85	9	10
SKT/H/1-4/10/UG	10	25	13.85	10	10
SKT/H/1-4/11/UG	11	25	15.85	11	10
SKT/H/1-4/12/UG	12	25	16.85	12	10
SKT/H/1-4/13/UG	13	25	17.85	13	10
SKT/H/1-4/14/UG	14	25	19.65	14	10
HEX SOCKETS - DEEP 					
SKT/H/1-4/5D/UG	5	50	8.0	11.9	10
SKT/H/1-4/6D/UG	6	50	9.3	11.9	10
SKT/H/1-4/7D/UG	7	50	10.5	11.9	10
SKT/H/1-4/8D/UG	8	50	11.9	11.9	10
SKT/H/1-4/9D/UG	9	50	13.2	13.2	10
SKT/H/1-4/10D/UG	10	50	14.6	14.6	10
SKT/H/1-4/11D/UG	11	50	15.9	15.9	10
SKT/H/1-4/12D/UG	12	50	17	17	10
SKT/H/1-4/13D/UG	13	50	18	18	10
POZI BIT SOCKETS 					
SKT/1-4/PZ1/UG	PZ1	37	6.35	12	10
SKT/1-4/PZ2/UG	PZ2	37	6.35	12	10
SKT/1-4/PZ3/UG	PZ3	37	6.35	12	10

ORDERING INFORMATION

CAT NR.	SIZE	L (MM)	D1 (MM)	D2 (MM)	BOX QTY.
	(MM)				
HEX BIT SOCKETS 					
SKT/1-4/H3/UG	H3	37	3	12	10
SKT/1-4/H4/UG	H4	37	4	12	10
SKT/1-4/H5/UG	H5	37	5	12	10
SKT/1-4/H6/UG	H6	37	6	12	10
SKT/1-4/H7/UG	H7	37	7	12	10
SKT/1-4/H8/UG	H8	37	8	12	10
SKT/1-4/H10/UG	H10	37	10	12	10
TORX BIT SOCKETS 					
SKT/1-4/T8/UG	T8	37	2.25	12	10
SKT/1-4/T10/UG	T10	37	2.70	12	10
SKT/1-4/T15/UG	T15	37	3.25	12	10
SKT/1-4/T20/UG	T20	37	3.80	12	10
SKT/1-4/T25/UG	T25	37	4.40	12	10
SKT/1-4/T27/UG	T27	37	5.0	12	10
SKT/1-4/T30/UG	T30	37	5.50	12	10
SKT/1-4/T40/UG	T40	37	6.60	12	10
SLOTTED BIT SOCKETS 					
SKT/1-4/S4/UG	4	37	4	12	10
SKT/1-4/S5.5/UG	5.5	37	5.5	12	10
SKT/1-4/S7/UG	7	37	7	12	10
PHILIPS BIT SOCKETS 					
SKT/1-4/PH1/UG	PH1	37	6.35	12	10
SKT/1-4/PH2/UG	PH2	37	6.35	12	10
SKT/1-4/PH3/UG	PH3	37	6.35	12	10

Hand Sockets (continued)

1/2" DRIVE

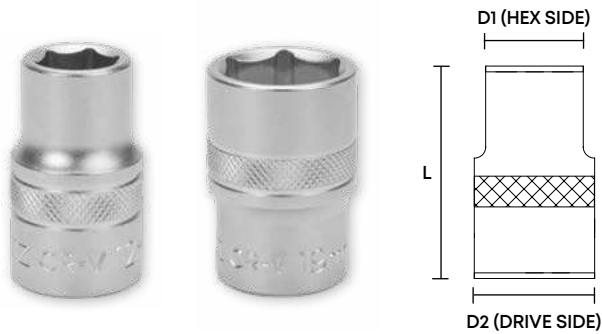

ORDERING INFORMATION

CAT NR.	SIZE (MM)	L (MM)	D1 (MM)	D2 (MM)	BOX QTY.
HEX SOCKETS					
* SKT/H/1-2/8/UG	8	38	13.20	21.80	15
SKT/H/1-2/9/UG	9	38	13.90	21.80	15
* SKT/H/1-2/10/UG	10	38	15.00	21.80	15
SKT/H/1-2/11/UG	11	38	16.30	21.80	15
* SKT/H/1-2/12/UG	12	38	17.60	21.80	15
* SKT/H/1-2/13/UG	13	38	18.80	21.80	15
* SKT/H/1-2/14/UG	14	38	20.40	21.80	15
SKT/H/1-2/15/UG	15	38	21.65	20.70	12
SKT/H/1-2/16/UG	16	38	22.90	21.50	12
* SKT/H/1-2/17/UG	17	38	23.90	22.00	10
SKT/H/1-2/18/UG	18	38	25.45	23.00	10
* SKT/H/1-2/19/UG	19	38	25.85	23.00	10
SKT/H/1-2/20/UG	20	38	27.85	24.00	8
* SKT/H/1-2/21/UG	21	38	27.85	25.00	6
SKT/H/1-2/22/UG	22	40	29.85	26.00	6
SKT/H/1-2/23/UG	23	40	31.65	27.00	6
* SKT/H/1-2/24/UG	24	42	31.85	28.00	6
SKT/H/1-2/25/UG	25	42	33.85	30.00	6
SKT/H/1-2/26/UG	26	42	35.45	30.00	4
* SKT/H/1-2/27/UG	27	43	35.85	30.00	4
SKT/H/1-2/28/UG	28	43	37.85	32.00	4
SKT/H/1-2/29/UG	29	43	37.85	32.00	4
* SKT/H/1-2/30/UG	30	46	39.85	34.00	4
* SKT/H/1-2/32/UG	32	46	41.85	36.00	4
SKT/H/1-2/33/UG	33	46	43.85	38.00	2
SKT/H/1-2/36/UG	36	46	47.85	38.00	2

* Best Seller

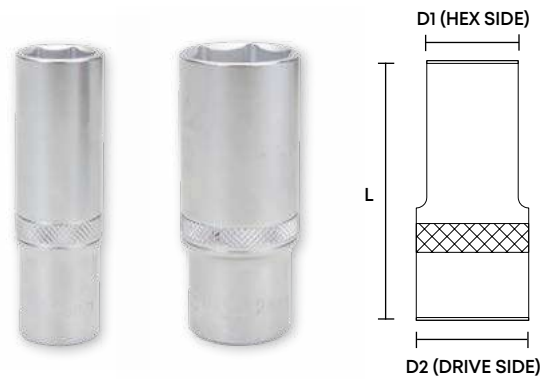

ORDERING INFORMATION

CAT NR.	SIZE (MM)	L (MM)	D1 (MM)	D2 (MM)	BOX QTY.
HEX SOCKETS					
* SKT/H/1-2/10D/UG	10	77	15	21.95	15
SKT/H/1-2/11D/UG	11	77	16.30	21.95	15
* SKT/H/1-2/12D/UG	12	77	17.60	21.95	15
* SKT/H/1-2/13D/UG	13	77	18.80	21.95	15
* SKT/H/1-2/14D/UG	14	77	20.40	21.95	15
SKT/H/1-2/15D/UG	15	77	21.60	20.70	12
SKT/H/1-2/16D/UG	16	77	22.85	21.50	12
* SKT/H/1-2/17D/UG	17	77	23.85	22.00	10
SKT/H/1-2/18D/UG	18	77	25.40	23.00	10
* SKT/H/1-2/19D/UG	19	77	25.85	23.00	10
SKT/H/1-2/20D/UG	20	77	27.85	24.00	8
SKT/H/1-2/21D/UG	21	77	27.85	25.00	8
SKT/H/1-2/22D/UG	22	77	29.85	26.00	6
SKT/H/1-2/23D/UG	23	77	31.60	27.00	6
SKT/H/1-2/24D/UG	24	77	31.85	28.00	6
SKT/H/1-2/26D/UG	26	77	35.40	30.00	6
SKT/H/1-2/27D/UG	27	77	35.85	30.00	6
SKT/H/1-2/28D/UG	28	77	37.85	32.00	4
SKT/H/1-2/29D/UG	29	77	37.85	32.00	4
SKT/H/1-2/30D/UG	30	77	39.85	34.00	4
SKT/H/1-2/32D/UG	32	77	41.85	36.00	4

* Best Seller



3/4" DRIVE



1" DRIVE

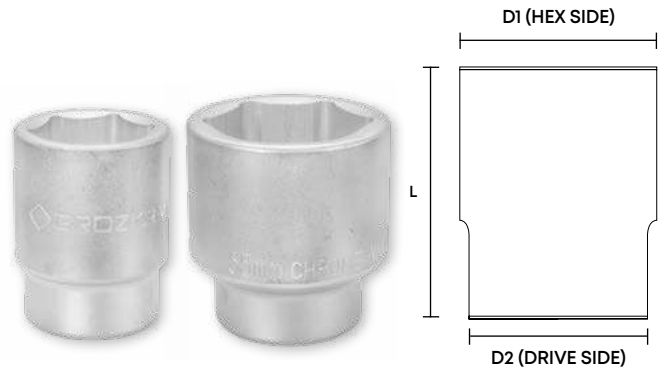

ORDERING INFORMATION

CAT NR.	SIZE	L	D1	D2	BOX QTY.
	(MM)	(MM)	(MM)	(MM)	

HEX SOCKETS 					
SKT/H/3-4/22/MT	22	50	33	36	6
SKT/H/3-4/24/MT	24	50	35	36	6
*SKT/H/3-4/27/MT	27	52	38	36	6
SKT/H/3-4/28/MT	28	52	38	38	6
*SKT/H/3-4/30/MT	30	54	42	38	4
*SKT/H/3-4/32/MT	32	56	44	38	4
*SKT/H/3-4/36/MT	36	58	50	42	4
SKT/H/3-4/38/MT	38	62	52	45	4
SKT/H/3-4/41/MT	41	64	56	45	4
SKT/H/3-4/46/MT	46	68	62	48	4
SKT/H/3-4/50/MT	50	72	68	48	2

* Best Seller

ORDERING INFORMATION

CAT NR.	SIZE	L	D1	D2	BOX QTY.
	(MM)	(MM)	(MM)	(MM)	

HEX SOCKETS 					
SKT/H/0-1/36/MT	36	65	51	45	4
SKT/H/0-1/41/MT	41	70	57	45	4
SKT/H/0-1/46/MT	46	75	65	50	4
SKT/H/0-1/50/MT	50	75	70	55	2
SKT/H/0-1/55/MT	55	80	76	57	2
SKT/H/0-1/60/MT	60	84	82	57	2
SKT/H/0-1/65/MT	65	87	88	57	1
SKT/H/0-1/70/MT	70	93	94	68	1
SKT/H/0-1/75/MT	75	97	100	68	1
SKT/H/0-1/80/MT	80	103	105	68	1

Socket Merchandiser

Heavy duty steel construction in premium powder coated finish

CAT NR.	CONTENTS	BOX QTY.
SKT/H/1-2/UG/ST50	49 Hex Sockets of following sizes: 7 pcs: 10 mm 7 pcs: 13 mm 7 pcs: 17 mm 6 pcs: 19 mm 5 pcs: 22 mm 5 pcs: 24 mm 4 pcs: 27 mm 4 pcs: 30 mm 4 pcs: 32 mm	1

1/2" DRIVE



IMPACT SOCKETS



67

Impact Sockets
Hex

1/2" DRIVE

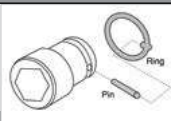

Pin Hole for Retaining Ring & Pin

CrMo

38-55 HRC

New range of impact sockets from GROZ are designed to withstand high levels of torque & impact applications

Chrome Molybdenum Construction
Forged from high quality Chrome Molybdenum Steel, precision machined & heat treated to provide the best combination of hardness, tensile strength & torque

Specially designed chamfered openings make engagement with the impact tools much easier, thereby saving time and effort

Pin hole in the impact sockets facilitates use with impact tools having pin and ring retaining mechanism

Black Oxide Finish
For enhanced corrosion protection and easy identification from regular sockets

Marking & Branding
Branding & size laser etched on each individual socket ensuring quick and convenient identification

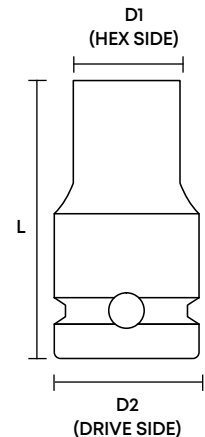

ORDERING INFORMATION

CAT NR.	SIZE (MM)	L (MM)	D1 (MM)	D2 (MM)	BOX QTY.
HEX SOCKETS					
* ISKT/H/1-2/10	10	38	16.7	25	15
ISKT/H/1-2/11	11	38	18.0	25	15
* ISKT/H/1-2/12	12	38	19.0	25	15
ISKT/H/1-2/13	13	38	20.2	25	15
ISKT/H/1-2/14	14	38	21.5	25	15
ISKT/H/1-2/15	15	38	23.0	25	12
ISKT/H/1-2/16	16	38	24.5	25	12
* ISKT/H/1-2/17	17	38	26.0	25	10
ISKT/H/1-2/18	18	38	27.0	25	10
* ISKT/H/1-2/19	19	38	28.0	25	10
* ISKT/H/1-2/21	21	38	30.0	25	8
ISKT/H/1-2/24	24	38	34.0	30	6
ISKT/H/1-2/27	27	42	40.0	30	6

HEX SOCKETS - DEEP

ISKT/H/1-2/14D	14	78	22	25	15
ISKT/H/1-2/17D	17	78	26	30	10
ISKT/H/1-2/18D	18	78	27	30	10
ISKT/H/1-2/19D	19	78	28	30	10
ISKT/H/1-2/20D	20	78	29	30	8
ISKT/H/1-2/21D	21	78	30	30	8
ISKT/H/1-2/23D	23	78	33.8	30	6
ISKT/H/1-2/24D	24	78	33.8	30	6

* Best Seller



3/4" DRIVE

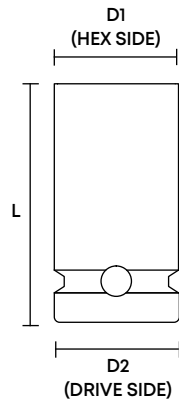

1" DRIVE

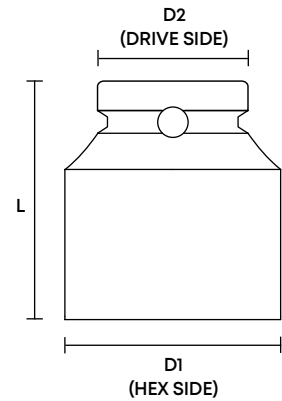

ORDERING INFORMATION

CAT NR.	SIZE (MM)	L (MM)	D1 (MM)	D2 (MM)	BOX QTY.
HEX SOCKETS					
ISKT/H/3-4/17	17	51	30.0	44	10
ISKT/H/3-4/19	19	51	32.5	44	8
ISKT/H/3-4/21	21	51	35.0	44	6
ISKT/H/3-4/22	22	51	36.0	44	6
ISKT/H/3-4/24	24	51	38.5	44	6
ISKT/H/3-4/27	27	53	42.5	44	6
ISKT/H/3-4/28	28	53	44	44	6
* ISKT/H/3-4/29	29	53	45.0	44	4
ISKT/H/3-4/30	30	53	46.0	44	4
* ISKT/H/3-4/33	33	57	50.0	44	4
ISKT/H/3-4/35	35	57	52.0	44	4
ISKT/H/3-4/36	36	57	53.0	44	4
ISKT/H/3-4/38	38	57	56.0	44	4
ISKT/H/3-4/41	41	58	59.0	44	4
ISKT/H/3-4/46	46	62	66.0	44	2
HEX SOCKETS - DEEP					
ISKT/H/3-4/24D	24	90	38	44	4
ISKT/H/3-4/27D	27	90	41	44	4
ISKT/H/3-4/28D	28	90	44	44	4

* Best Seller

ORDERING INFORMATION

CAT NR.	SIZE (MM)	L (MM)	D1 (MM)	D2 (MM)	BOX QTY.
HEX SOCKETS					
ISKT/H/0-1/19	19	58	35.0	54	8
ISKT/H/0-1/22	22	58	39.0	54	6
ISKT/H/0-1/24	24	58	41.5	54	6
ISKT/H/0-1/26	26	60	44.0	54	6
ISKT/H/0-1/27	27	60	45.0	54	6
* ISKT/H/0-1/29	29	62	45.0	54	4
ISKT/H/0-1/30	30	62	49.0	54	4
* ISKT/H/0-1/32	32	62	51.5	54	4
* ISKT/H/0-1/33	33	62	52.5	54	4
ISKT/H/0-1/35	35	66	55.0	54	4
ISKT/H/0-1/36	36	66	56.5	54	4
ISKT/H/0-1/38	38	66	59.0	54	4
ISKT/H/0-1/41	41	68	62.5	54	4
ISKT/H/0-1/46	46	72	69.0	54	4
ISKT/H/0-1/50	50	76	74.0	54	2
ISKT/H/0-1/55	55	84	80.0	54	2
ISKT/H/0-1/60	60	88	86.5	54	1
ISKT/H/0-1/65	65	92	92.5	54	1
HEX SOCKETS - DEEP					
ISKT/H/0-1/27D	27	90	46	54	4
ISKT/H/0-1/30D	30	90	49	54	2
ISKT/H/0-1/32D	32	90	52	54	2
ISKT/H/0-1/33D	33	90	54	54	2

* Best Seller

SLIDING T BARS

Manufactured from high quality Chrome Vanadium steel for strength & durability

Time & effort saving tool, provides right leverage for tightening nuts & bolts easily



ORDERING INFORMATION

CAT NR.	DRIVE	LENGTH		BOX QTY.
	(INCH)	(INCH)	(MM)	
SLTB/1-4/UG	1/4	4-1/2	115	10
SLTB/3-8/UG	3/8	6-1/2	165	10
SLTB/1-2/UG	1/2	10	250	5
SLTB/3-4/MT	3/4	18	450	1
SLTB/0-1/MT	1	22	550	1

EXTENSION BARS

Manufactured from high quality Chrome Vanadium steel for strength & durability

Corrosion resistant chrome plated finish

Used along with a socket to reach into confined spaces



ORDERING INFORMATION

CAT NR.	DRIVE	LENGTH		BOX QTY.
	(INCH)	(INCH)	(MM)	
DRXB/1-4/2/UG	1/4	2	50	10
DRXB/1-4/4/UG	1/4	4	100	10
DRXB/1-4/6/UG	1/4	6	150	10
DRXB/3-8/3/UG	3/8	3	75	5
DRXB/3-8/6/UG	3/8	6	150	5
DRXB/1-2/5/UG	1/2	5	125	5
DRXB/1-2/10/UG	1/2	10	250	5
DRXB/3-4/4/MT	3/4	4	100	10
DRXB/3-4/8/MT	3/4	8	200	5
DRXB/0-1/8/MT	1	8	200	5
DRXB/0-1/16/MT	1	16	400	2

L HANDLE

Manufactured from high quality Chrome Vanadium steel for strength & durability

Hardened & tempered with corrosion resistant chrome plated finish

Spring loaded ball bearing holds sockets securely

Fixed L Handle for applications requiring rigid set-up



ORDERING INFORMATION

CAT NR.	DRIVE	LENGTH		BOX QTY.
	(INCH)	(INCH)	(MM)	
LDH/1-2/UG	1/2	5	125	5

SPEEDER HANDLE

Chrome Vanadium construction with ultra premium finish

Ideal for rapid removal or insertion of fasteners, especially in repetitive work

Provides extra leverage with greater strength than ratchets



ORDERING INFORMATION

CAT NR.	DRIVE	BOX QTY.
	(INCH)	
SPDH/1-2/UG	1/2	5



UNIVERSAL JOINT

Manufactured from Chrome Vanadium for higher strength & durability

Hinged through 180° in both directions, helps the user to 'form corners' or to get socket onto inaccessible bolt heads



ORDERING INFORMATION

CAT NR.	DRIVE	BOX QTY.
	(INCH)	
UVJ/1-4/UG	1/4	10
UVJ/3-8/UG	3/8	5
UVJ/1-2/UG	1/2	5
UVJ/3-4/UG	3/4	5

ADAPTOR

For using a combination of square drive sockets in one application



ORDERING INFORMATION

CAT NR.	SIZE	BOX QTY.
SADP/1-4F/3-8M/UG	1/4" (F) to 3/8" (M)	5
SADP/3-8F/1-4M/UG	3/8" (F) to 1/4" (M)	5
SADP/3-8F/1-2M/UG	3/8" (F) to 1/2" (M)	5
SADP/1-2F/3-8M/UG	1/2" (F) to 3/8" (M)	5
SADP/1-2F/3-4M/UG	1/2" (F) to 3/4" (M)	5
SADP/3-4F/1-2M/UG	3/4" (F) to 1/2" (M)	5
SADP/3-4F/0-1M/UG	3/4" (F) to 1" (M)	2
SADP/0-1F/3-4M/UG	1" (F) to 3/4" (M)	2

HEX SPARK PLUG SOCKET

Designed for insertion & removal of spark plugs



ORDERING INFORMATION

CAT NR.	DRIVE	HEX SIZE	BOX QTY.
	(INCH)	(MM)	
SKT/1-2/SP/16/UG	1/2	16	5
SKT/1-2/SP/21/UG	1/2	21	5

FLEXIBLE EXTENSION

Manufactured from high quality Chrome Vanadium steel for strength & durability

Hardened & tempered with corrosion resistant chrome plated finish

Flexible Extension with compressed spring for use in confined spaces



ORDERING INFORMATION

CAT NR.	DRIVE	BOX QTY.
	(INCH)	
FLEX/1-4/G	1/4	10

SPINNER HANDLE

Manufactured from high quality Chrome Vanadium steel for strength & durability

Fit on a socket & spin it for rapid installation of longer bolts

1/4" (F) square recess allows spinner to be used with a ratchet & also works as a long extension



ORDERING INFORMATION

CAT NR.	DRIVE	BOX QTY.
	(INCH)	
DRSH/1-4/UG	1/4	10

69

**Socket Sets
in Blow Moulded Cases**

1/4" DRIVE

**HEX SOCKET SET
KIT/SKT/H/1-4/19/UG**

19
PIECE



DESCRIPTION	BOX QTY.
13 pcs Hex Sockets: 4, 4.5, 5, 5.5, 6, 7, 8, 9, 10, 11, 12, 13, 14 mm 1 pc Ratchet Handle 2 pcs Extension Bars: 50 & 100 mm (2" & 4") 1 pc Universal Joint 1 pc Sliding T Bar 1 pc Spinner Handle	10

**HEX SOCKET SET
KIT/SKT/H/1-4/42/UG**

42
PIECE



DESCRIPTION	BOX QTY.
13 pcs Hex Sockets: 4, 4.5, 5, 5.5, 6, 7, 8, 9, 10, 11, 12, 13, 14 mm 6 pcs Hex Bit Sockets: 3, 4, 5, 6, 7, 8 mm 3 pcs Slotted Bit Sockets: 4, 5.5, 7 mm 3 pcs Philips Bit Sockets: PH1, PH2, PH3 3 pcs Pozi Bit Sockets: PZ1, PZ2, PZ3 7 pcs Torx Bit Sockets: T8, T10, T15, T20, T25, T30, T40 2 pcs Extension Bars: 50 & 100 mm (2" & 4") 1 pc Spinner Handle 1 pc Flexible Extension 1 pc Universal Joint 1 pc Sliding T Bar 1 pc Ratchet Handle	10

**HEX SOCKET SET
KIT/HSK/1-4/46**

46
PIECE



DESCRIPTION	BOX QTY.
13 pcs 1/4" Hex Sockets: 4, 4.5, 5, 5.5, 6, 7, 8, 9, 10, 11, 12, 13 & 14 mm 22 pcs Bit Sockets: Hex: 3, 4, 5, 6, 7 & 8 mm Slotted: 4, 5.5 & 7 mm Philips: PH1, PH2 & PH3 Pozi: PZ1, PZ2 & PZ3 Torx: T8, T10, T15, T20, T25, T30 & T40 4pc Hex Keys 1 pc 1/4" Ratchet Handle 2 pcs 1/4" Extension Bar: 2" & 4" (50 & 100 mm) 1 pc 1/4" Universal Joint 1 pc 1/4" Sliding T Bar 1 pc 1/4" Spinner Handle 1 pc 1/4" Spinner Handle	5



1/2" DRIVE

**HEX SOCKET SET
KIT/SKT/H/1-2/13/UG**

13
PIECE



DESCRIPTION	BOX QTY.
11 pcs Sockets: 8, 9, 10, 11, 12, 13, 14, 15, 17, 19, 22 mm	5
1 pc Ratchet Handle	
1 pc Extension Bar: 125 mm (5")	

**HEX SOCKET SET
KIT/SKT/H/1-2/27/UG**

27
PIECE



DESCRIPTION	BOX QTY.
22 pcs Sockets: 8, 9, 10, 11, 12, 13, 14, 15, 16, 17, 18, 19, 21, 22, 23, 24, 26, 27, 28, 29, 30, 32 mm	5
2 pcs Extension Bars: 125 & 250 mm (5" & 10")	
1 pc Universal Joint	
1 pc Sliding T Bar	
1 pc Ratchet Handle	

**HEX SOCKET SET
KIT/HSK/1-2/25**

25
PIECE



DESCRIPTION	BOX QTY.
18 pcs 1/2" Hex Sockets: 8, 10, 11, 12, 13, 14, 15, 16, 17, 18, 19, 20, 21, 22, 24, 27, 30 & 32 mm	5
2 pcs 1/2" Spark Plug Sockets: 16 & 21 mm	
2 pcs 1/2" Extension Bar: 5" & 10" (125 & 250 mm)	
1 pc 1/2" Sliding T Bar	
1 pc 1/2" Universal Joint	
1 pc 1/2" Ratchet Handle	

70

Hand Socket Sets On Rails

1/4" DRIVE

HEX SOCKET SET KIT/SKT/H/1-4/9LH/UG



9

PIECE



DESCRIPTION	BOX QTY.
8 pcs Hex Sockets: 4, 4.5, 5, 5.5, 6, 7, 8, 10 mm 1 pc Ratchet Handle	5

3/8" DRIVE

HEX SOCKET SET KIT/SKT/H/3-8/8L/UG



8

PIECE



DESCRIPTION	BOX QTY.
8 pcs Sockets: 6, 8, 10, 12, 13, 14, 17, 19 mm	5

1/2" DRIVE

HEX SOCKET SET KIT/SKT/H/1-2/9L/UG



9

PIECE



DESCRIPTION	BOX QTY.
9 pcs Sockets: 8, 9, 10, 12, 13, 14, 17, 19, 22 mm	5

HEX SOCKET SET KIT/SKT/H/1-4/13L/UG



13

PIECE



DESCRIPTION	BOX QTY.
13 pcs Hex Sockets: 4, 4.5, 5, 5.5, 6, 7, 8, 9, 10, 11, 12, 13, 14 mm	5

HEX SOCKET SET KIT/SKT/H/3-8/9LH/UG



9

PIECE



DESCRIPTION	BOX QTY.
8 pcs Sockets: 6, 8, 10, 12, 13, 14, 17, 19 mm 1 pc Ratchet Handle	5

HEX SOCKET SET KIT/SKT/H/1-2/11LH/UG



11

PIECE



DESCRIPTION	BOX QTY.
10 pcs Sockets: 8, 9, 10, 12, 13, 14, 17, 19, 22, 24 mm 1 pc Ratchet Handle	5



1/2" DRIVE

BIT SOCKET SET
KIT/BIT-SKT/SPL/1-2/6/UG

6

PIECE



DESCRIPTION	BOX QTY.
Spline Bit Sockets: 55mm length: M6, M8, M10 100mm length: M8, M10, M12;	5

TORX BIT SOCKET SET
KIT/BIT-SKT/TX/1-2/9/UG

9

PIECE



DESCRIPTION	BOX QTY.
Torx Bit Socket: T20, T25, T27, T30, T40, T45, T50, T55, T60	5

HEX BIT SOCKET SET
KIT/BIT-SKT/H/1-2/8/UG

8

PIECE



DESCRIPTION	BOX QTY.
8 pcs Hex Bit Sockets: 5, 6, 7, 8, 10, 12, 14, 17 mm	5

71

**Hand Socket Sets
in Metal Cases**

KIT-SKT

3/4" DRIVE

HEX SOCKET SET
KIT/SKT/H/3-4/14/MT

14

PIECE



DESCRIPTION	BOX QTY.
10 pcs Sockets: 22, 24, 27, 30, 32, 36, 38, 41, 46, 50mm 1 pc Round Head Ratchet Handle 2 pc Extension Bars: 100 & 200 mm (4" & 8") 1 pc Sliding T Bar	1

1" DRIVE

HEX SOCKET SET
KIT/SKT/H/0-1/14/MT

14

PIECE



DESCRIPTION	BOX QTY.
10 pcs Sockets: 36, 41, 46, 50, 55, 60, 65, 70, 75, 80 mm 1 pc Ratchet Handle 2 pc Extension Bars: 200 & 400 mm (8" & 16") 1 pc Sliding T Bar	1



Chrome Vanadium Construction

Forged from high quality chrome vanadium steel, precisely hardened for increased durability

Unique Patented Design

30% slimmer & lighter than normal pear head ratchet, provides higher torque & extended service life



Unique Patented Design

Gourd shaped head is 30% narrower than regular oval shaped ratchets making these most suitable for use in tight & hard to reach areas

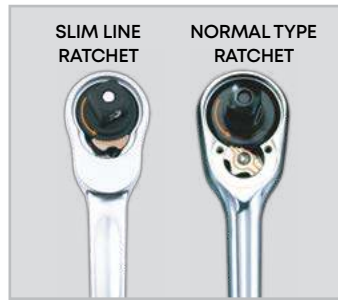

Slim Line Ratchet

More than 9 Teeth Bite of Gear is designed to transfer extremely high torque and extend the service life

Normal Type Ratchet

Only 3 teeth bite, unable to transfer the torque powerfully and efficiently

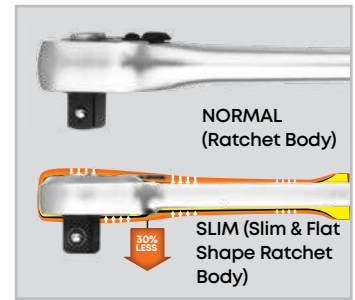

Ratchet body is 30% slimmer than regular ratchet handles. This reduces the weight of the ratchet handles & provides high torque

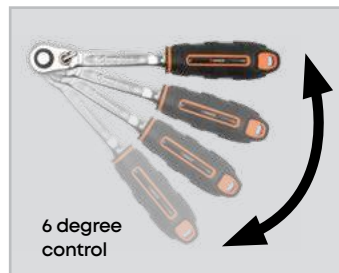

60 Teeth With 6 Degree Control

Provides extremely high torque for professional users



Quick Release

Simply push the release button with one thumb for replacing sockets quickly and efficiently



Reversible Lever Switch

Reversible lever switch makes it easy to switch direction of use

ORDERING INFORMATION

CAT NR.	DRIVE	LENGTH		TORQUE		BOX QTY.
	(INCH)	(INCH)	(MM)	(NM)	(FT-LB)	
RTD/SL/1-4/UG	1/4	5.70	145	80	59	5
RTD/SL/3-8/UG	3/8	7.81	199	270	199	5
RTD/SL/1-2/UG	1/2	10.03	255	670	494	5

73

Round Head Ratchet Handle

RTD-RH

Chrome Vanadium construction for higher strength & durability

Classic round head ratchet mechanism for reliable performance

Spring loaded ball attaches onto sockets, preventing them from being dropped

Durable, corrosion resistant chrome plated finish

Knurled handle for non-slip grip



ORDERING INFORMATION

CAT NR.	DRIVE (INCH)	LENGTH		NUMBER OF TEETH	TORQUE		BOX QTY.
		(INCH)	(MM)		(NM)	(FT-LB)	
RTD/RH/3-4/MT	3/4	19.6	500	43	1412	1041	1

74

Pear Head Ratchet Handle

RTD-PH

Forged from high quality chrome vanadium steel for higher strength & durability

Classic pear head design for strength, durability & high performance

2 piece construction with detachable head for convenient storage

Spring loaded ball attaches onto sockets preventing them from being dropped



2pc construction with detachable head

ORDERING INFORMATION

CAT NR.	DRIVE (INCH)	LENGTH		TORQUE		BOX QTY.
		(INCH)	(MM)	(NM)	(FT-LB)	
RTD/PH/3-4/MT	3/4	19-11/16	500	2000	1475	1
RTD/PH/0-1/MT	1	26-3/8	670	2515	1855	1



02

**LED
WORKLIGHTS**

75

Worklight Cable Reel

LED-800

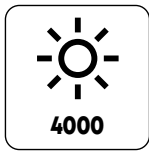

4000 lumens worklight with built-in cable reel

Sturdy Construction

- a. **IP 54 Rated**
Protected against dust and effects of water spray from any direction
- b. **IK 07 Rated**
Impact-proof aluminium die cast housing with polycarbonate lens will stand-up to tough jobsite conditions
- c. In-built handle for comfortable grip
- d. Complete with 5m (16ft) cable with a socket useful to connect multiple lights in series for higher illumination

Versatile Use

- a. Free standing worklight with adjustable swivel stand
- b. Attached to any metallic surface using 4 super strong magnets at the back of light

CE
RoHS
IP54
IK07



POWER SOURCE

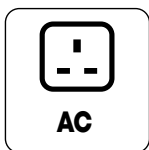

220V AC, 50Hz



90° rotating COB light to focus beam as needed



4 Super strong magnets on the back



3000W Socket on one end, to connect multiple lights in series or use the socket to connect to a power tool

ORDERING INFORMATION

CAT NR.	PLUG TYPE	POWER SOURCE	BOX QTY.
LED/800/EU	EU	220V AC, 50Hz	1



76

Worklight Impact Resistant

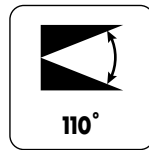
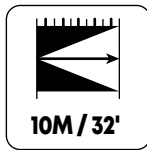

Powerful rechargeable COB worklight designed for the professional user

Available in two versions

- a. LED-550 10W COB
- b. LED-560 20W COB

Light Output

Single button controlled variable output. Simply push button to change from 50% intensity to full 100% power

Sturdy Construction

- a. **IP 54 Rated**
Protected against dust and effects of water spray from any direction
- b. **IK 07 Rated**
Impact proof & corrosion resistant aluminium die cast housing in premium powder coated finish with rubberised edge guards make it resistant to shocks and vibration – common on any jobsite

Versatile Use

Can be used as:

- a. Free standing worklight with mounting bracket that can be rotated 180° to focus light in need
- b. Attached to any metallic surface using the magnetic base plate. The magnetic base plate can be easily removed
- c. Hung from a scaffolding, bracket Handle is designed for direct mounting on the scaffolding bracket leaving both hands free for any other job

Complete with USB cable & magnet holder

Charging of Battery

Battery can be recharged using standard USB cable provided with the light

Charge Your Phone

Rechargeable and removable battery pack also doubles up as a power bank



LED-550
10W COB

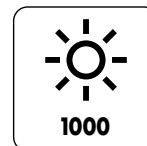

INTENSITY	100%	50%
LUMEN	1000	500
RUN TIME	3 hours	6 hours

POWER SOURCE

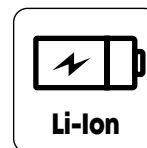

3.7V 4400 mAh

ORDERING INFORMATION

CAT NR.	SIZE (L×H)		BOX QTY.
	(INCH)	(MM)	
LED/550	6-11/16 × 5	170 × 125	10

LED-550

LED-560

CE
RoHS
IP54
IK07



Use magnetic base to attach to any metallic surface



Mounting bracket can be rotated 180°



Impact Resistant

LED-560
20W COB

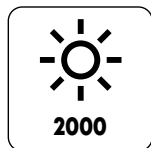

INTENSITY	100%	50%
LUMEN	2000	1000
RUN TIME	3 hours	6 hours

POWER SOURCE

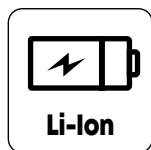

7.4V 4400 mAh

ORDERING INFORMATION

CAT NR.	SIZE (LxH)		BOX QTY.
	(INCH)	(MM)	
LED/560	7-9/32 x 5-1/2	185 x 140	8



In-built power banks to change mobile devices

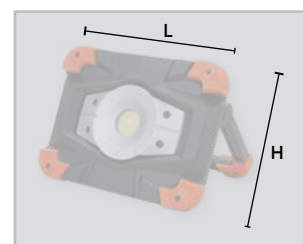
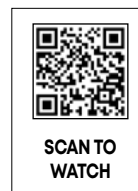

77

Worklight Dual Power



Dual power worklight for use on construction sites, in general maintenance, workshops etc.

Light Output

Single button controlled variable output. Simply push button to change from 50% to full 100% intensity

	LITHIUM ION BATTERY		AC SUPPLY
INTENSITY	100%	50%	100%
LUMEN	2800	1400	2800
RUN TIME	2 hours	4 hours	-

Cool Light

Finned design reduces heating up of light

Sturdy Construction

a. IP 54 Rated

Protected against dust and effects of water spray from any direction

b. IK 07 Rated

Impact-proof & corrosion resistant aluminium die cast housing in premium powder coated finish. Rubberised edge guards make the light resistant to shocks and vibration – common in on any jobsite

Versatile Use

Can be used as:

- Free standing worklight with mounting bracket
- On magnetic base - removable magnetic base can be attached onto any metallic surface leaving both hands free
- On tripod stand to light overhead work or minimise shadows when directing the light downwards

Charge Your Phone

Rechargeable and removable battery pack also doubles as a power bank

DUAL POWER SOURCE



7.4V 4400 mAh

220V AC, 50Hz



LED-670
Worklight



Portable



Mounting bracket pivots full 180° to focus light as required

LED-670

LED-670T

CE
RoHs
IP54
IK07



Rechargeable
Li-ion battery



In-built power bank to charge
mobile devices



AC Supply



ORDERING INFORMATION

CAT NR.	DESCRIPTION	SIZE (LxHxD)		BOX QTY.
		(INCH)	(MM)	
LED/670	Worklight	9.5 x 10 x 5	24 x 26 x 13	4
LED/670T	Worklight complete with tripod	46 x (48 to 75-1/2) x 46	117 x (122 - 192) x 117	4



78

Cordless Sitelamp 3 Head Design

NEW!



Triple Head sitelamp for 360° multi-directional illumination

Easy set-up light, this is ideal for use in automotive repair work, roadside emergencies, construction sites, camping etc.

Adjustable 3 blades design for multi-directional light. Heads can be independently rotated to cast light in several directions simultaneously

Control panel to adjust intensity & switch between warm and cool light

	1ST PRESS	2ND PRESS	3RD PRESS	WHILE CHARGING
INTENSITY	LOW	MEDIUM	HIGH	MEDIUM
LUMEN	700	1200	2000	1200
RUN TIME	8.5 hours	3.5 hours	1.5 hours	-

Sturdy Construction

- a. **IP 54 Rated**
Protected against dust and effects of water spray from any direction
- b. **IK 07 Rated**
Impact proof & corrosion resistant aluminium Body in premium powder coated finish. ABS edge guards make it resistant to shocks and vibration – common on any jobsite
- c. Nylon hook with 360° rotating action

Versatile Use

- Can be used as
 - a. Compact and portable, free standing floodlight bright enough to light up large areas
 - b. Attached to any metallic surface using the magnetic base
 - c. On tripod stand to light overhead work and minimize shadows when directing the light downwards

Charging of Battery

Type-C fast charging protected by rubberized bezel. Charge indicated via 4 LED's, each showing 25% charge

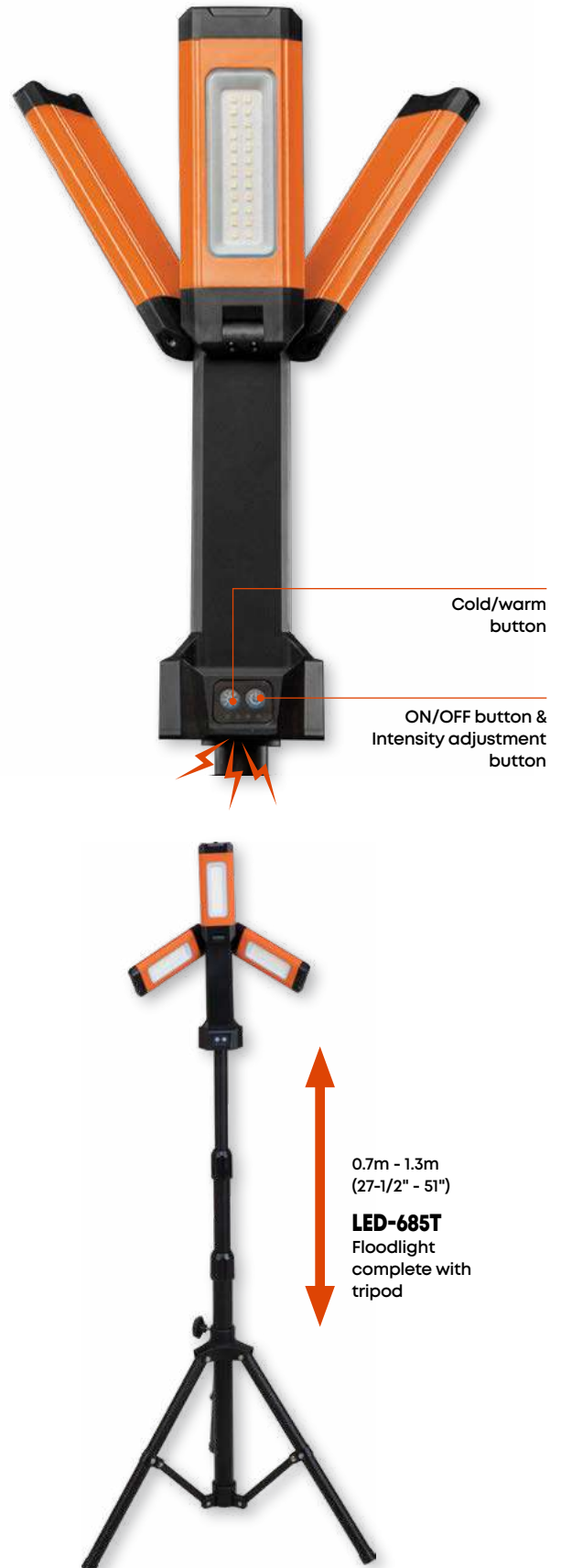

POWER SOURCE

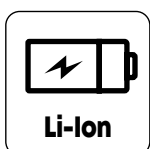

3.7V 4000 mAh

LED-685



Nylon hook with 360° rotation



Adjustable blade design
270° rotating light folds back into a compact sitelamp & 180° pivoting action to direct light in the desired direction



Hands-free operation
3 super strong magnet on base



CE
RoHs
IP54
IK07

WARM LIGHT



4000K

COOL LIGHT



6500K

ORDERING INFORMATION

CAT NR.	DESCRIPTION	SIZE (L×H×D)		BOX QTY.
		(INCH)	(MM)	
LED/685	Sitelamp	3-13/64 × 8-9/32 × 3-3/32	81.2 × 210.5 × 78.4	1
LED/685T	Sitelamp complete with tripod	28-17/64 × 6-27/64 × 19-9/16	718 × 1630 × 497	1

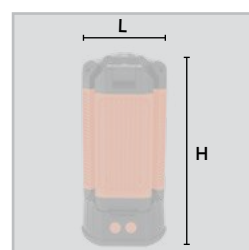

79

Site Lamp AC Powered

LED-602

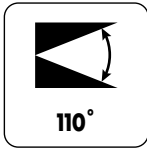
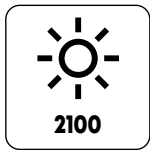

CE
RoHs
IP65

Powerful 28 SMD portable light for use on construction sites, workshop etc.

Light Output

High quality output of 2100 lumen for maximum coverage of workspace

Cool Light

Finned design reduces heating up of light

Sturdy Construction

a. IP 65 Rated

Protected against dust and effects of pressure jets from any direction

- b. Corrosion resistant aluminium die-cast housing in premium powder coated finish
- c. High impact polycarbonate lens to withstand harsh job site conditions
- d. Complete with 4m (13') long power cord

Portable

Free standing steel stand with cushion grip and adjustable bracket makes it convenient to move light as required in the workspace

Easy Set-up and instant illumination



POWER SOURCE

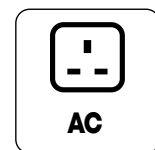

220V AC, 50Hz

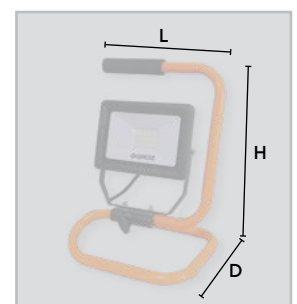

ORDERING INFORMATION

CAT NR.	PLUG TYPE	SIZE (L×H×D)		BOX QTY.
		(INCH)	(MM)	
LED/602/EU	EU Pin	9-1/16 × 14-3/16 × 8	230 × 360 × 205	8

80

Site Lamp with Tripod AC Powered

LED-612

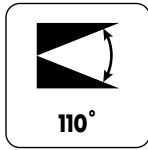
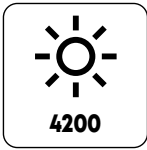

Powerful 2x30 SMD easy set up tower light for professional users on construction sites, workshops etc.

Light Output

High quality output of 4200 lumen for maximum coverage of workspace

Cool Light

Finned design reduces heating up of light

Sturdy Construction

- a. **IP 65 Rated**
Protected against dust and effects of pressure jets from any direction
- b. Corrosion resistant aluminium die cast housing in premium powder coated finish
- c. Telescopic stand can be extended from 0.8m - 1.72m (31 - 67 inch) to light overhead work or minimise shadows when casting light downwards
- d. Complete with 4m (13') long power cord

CE
RoHs
IP65

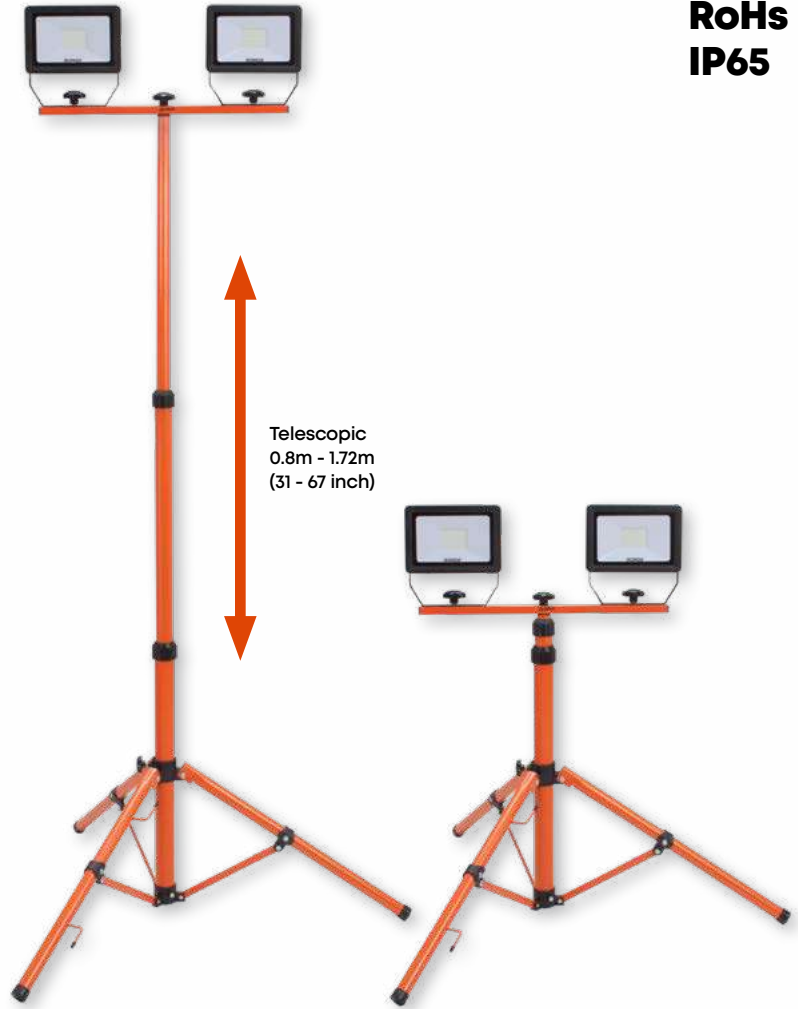

Telescopic
0.8m - 1.72m
(31 - 67 inch)

POWER SOURCE

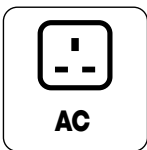

220V AC, 50Hz

ORDERING INFORMATION

CAT NR.	PLUG TYPE	SIZE (LxHxD)		BOX QTY.
		(INCH)	(MM)	
LED/612/EU	EU Pin	37 x 68-3/32 x 37	940 x 1730 x 940	2

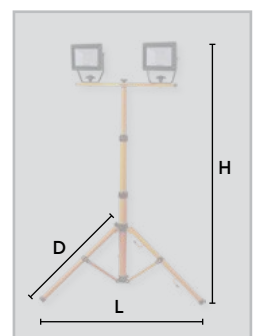

81

Foldable Worklight AC Powered

LED-616

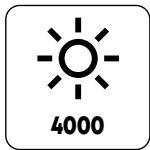

NEW! CE
RoHs
IP54
IK08

Distinctive ergonomic design for illuminating the darkest of areas. Easy set-up for instant illumination

Light Output

INTENSITY BUTTON	1ST PRESS	2ND PRESS
INTENSITY	100%	50%
LUMEN	4000	2000

Sturdy Construction

- IP 54 Rated**
Protected against dust and effects of water spray from any direction
- IK 08 Rated**
Impact-proof aluminium body with polycarbonate lens will withstand tough jobsite conditions
- In-built handle for comfortable grip
- Complete with 4.5m long power cord

Portable

Free standing steel stand and adjustable bracket makes it convenient to move light as required in the workspace



POWER SOURCE

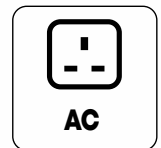

220V AC, 50Hz



Compact Design: Fully foldable light for easy storage



Turn the heads to focus light beam on the job

ORDERING INFORMATION

CAT NR.	PLUG TYPE	POWER SOURCE	SIZE (LxHxD) (OPEN)		SIZE (LxHxD) (CLOSE)		BOX QTY.
			(INCH)	(MM)	(INCH)	(MM)	
LED/616/EU	EU	220V AC, 50 Hz	15-3/4 × 10-3/4 × 7-1/2	400 × 274 × 190	9-1/6 × 8-13/16 × 7-1/2	231 × 224 × 190	2

82

Worklight Glare Free - Pocket Sized

LED-398



NEW! **CE**
RoHs
IP65
IK07

Pocket sized, glare-free worklight

Integrated

- 3W SMD Top Torch
- 6W COB Main Light

User controlled output

	1ST PRESS	2ND PRESS	3RD PRESS
	TOP TORCH	MAIN LIGHT	
INTENSITY	HIGH	LOW	HIGH
LUMEN	250	150	600
RUN TIME	6 hrs	8 hrs	3 hrs

Sturdy Construction

- IP 65 Rated**
Protected against dust and effects of water jets from any direction
- IK 07 Rated**
Impact Resistant ABS Body will withstand tough jobsite conditions

Glare Free light helps in working for longer times as there is no shadow formation

Fully Flexible

360° Swivelling Body and 210° swivelling base stand to direct light wherever needed

Hands Free Operation

Rotating bracket equipped with **Base Magnets:** 2 super strong magnets to mount lights flat on any metallic surface

End Magnets: To mount the light vertically onto any metallic surface

Charging of Battery

Type C fast charging protected by rubberized bezel (cable included)



Hands free operation



Base magnets

End magnets

ORDERING INFORMATION

CAT NR.	SIZE (L×H×D)		BOX QTY.
	(INCH)	(MM)	
LED/398	4-23/32 × 1-31/32 × 1-11/32	117 × 50 × 34	10

POWER SOURCE

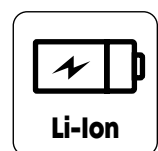

3.7V 2600 mAh

83

Worklight 270° Swivelling with Magnetic Base

LED-621



CREE
IP65

6 powerful LED's of 3W each

Multiple Working Modes

High intensity, low intensity & SOS flashing

	RUN TIME	LUMEN
HIGH INTENSITY	3 hours	1000
LOW INTENSITY	10.5 hours	300
SOS FLASHING		

Weather Proof Construction

a. IP 65 Rated

Protected against dust and effects of low pressure water jets from any direction

- b. Corrosion resistant aluminium die cast construction in premium powder coated finish
- c. Free standing heavy duty magnetic base
- d. Sturdy polycarbonate lens to withstand the toughest of job site conditions

Ideal For Portable Working

In maintenance, building, construction, mining jobs etc.



Finned design offers excellent heat dissipation



270°
Rotation

POWER SOURCE



Li-Ion

3.7V 6600 mAh

ORDERING INFORMATION

CAT NR.	SIZE (L×H×D)		BOX QTY.
	(INCH)	(MM)	
LED/621	5-1/16 × 9-19/32 × 4	129 × 244 × 100	5

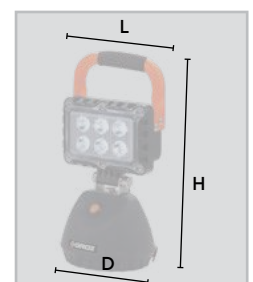

84

Worklight 360° Rotating Hook

LED-390

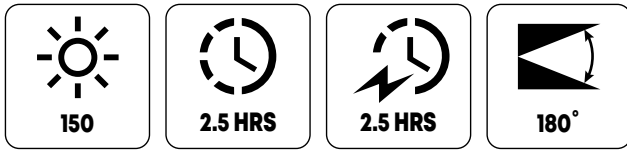

CE
RoHS

Multi-function, powerful worklight & top torch

Light Output

High quality output of 160 lumen by main light & focused illumination of 60 lumen by top torch

1ST PRESS	TOP TORCH ON
2ND PRESS	WORKLIGHT ON
3RD PRESS	ALL LIGHTS OFF

Durable Construction

- Impact proof & water resistant ABS body with rubber coating
- 360° rotating hook to suspend light leaving both hands free
- Integrated pocket/belt clip to conveniently store and carry light wherever you go
- Swivelling magnetic stand swivels up to 180° to adjust to required angle

Hands Free Operation

- Swivelling stand with super strong magnets to position light on any metallic surface
- Magnet on clip can also be used to affix light on any metal surface

Charge Time

3 hours. Indicated via LED display

Charging of Battery

Battery can be recharged using a standard USB cable provided with the light

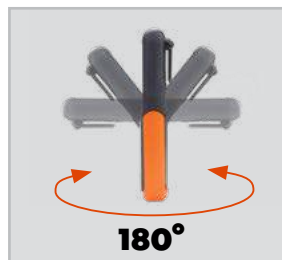

Swivelling Magnetic Stand

POWER SOURCE

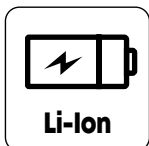

3.7V 1200 mAh

ORDERING INFORMATION

CAT NR.	SIZE (LxHxD)		BOX QTY.
	(INCH)	(MM)	
LED/390	6-7/64 x 1-37/64 x 1-11/64	155 x 40 x 30	50

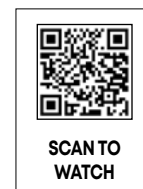

Twin-head light for endless applications; both indoors and outdoors

High Output

Twin-heads deliver high quality and uniform illumination

Heads can be used separately or both together for all-around illumination

Single push-button controlled output

Sturdy Construction

Impact-resistant nylon body with protective TPR corners

Nylon handle swivels full 360° for adjustment as needed

Handle also doubles up as a stand for convenient placement on a flat surface

Suitable for use in

Automotive, Industrial, Construction, Camping etc.

Available in two versions

a. LED/385

Runs on 4 x AA drycell batteries (included)

b. LED385RM

Runs on 3.7V 5000 mAh lithium polymer battery (included)



Powerful 2x10W SMD

Rubberised (TPR) corner protectors

Swivel Handle

LED/385

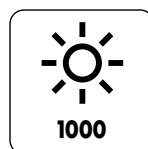

POWER SOURCE

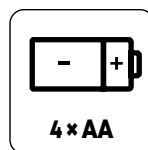

MULTIPLE WORKING MODES

	1ST PRESS	2ND PRESS	3RD PRESS
	BOTH LIGHTS ON	LIGHT 1 ON	LIGHT 2 ON
LUMEN	1000	500	500
RUN TIME	3 hours	4 hours	4 hours

ORDERING INFORMATION

CAT NR.	BOX QTY.
LED/385	10

LED-385

LED-385RM

CE
RoHS



LED/385RM



5V 1A USB output port to charge mobiles



Hands free magnet on swivel handle can also be used to affix light on any metal surface

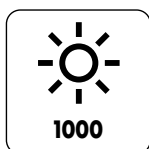

POWER SOURCE

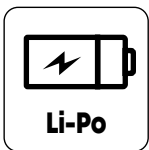

3.7V 5000 mAh

MULTIPLE WORKING MODES

	1ST PRESS	2ND PRESS	3RD PRESS
	BOTH LIGHTS ON	LIGHT 1 ON	LIGHT 2 ON
LUMEN	1000	500	500
RUN TIME	3 hours	6 hours	6 hours

ORDERING INFORMATION

CAT NR.	BOX QTY.
LED/385RM	10



Swivel Handle



86

Worklight Intensity Control



Multi-function, powerful worklight & top torch

Integrated

- a. 5W COB Mainlight
- b. 3W LED Top Torch

Light Output

User controlled output. Adjust light intensity of worklight and top torch by pressing on the + (increase) or - (decrease) buttons

Built-in memory function starts the light at the same intensity as when it was switched off

Durable Construction

- a. Impact proof & water resistant ABS body with rubber coating
- b. 360° rotating hook to suspend light leaving both hands free
- c. Integrated pocket/belt clip

Hands Free Operation

- a. Swivelling stand with super strong magnets to position light on any metallic surface
- b. Magnet on clip can also be used to affix light on any metal surface

Charging of Battery

Battery can be recharged using standard USB cable provided with the light

Charge Your Mobile Device

USB output port for use as power bank



POWER SOURCE

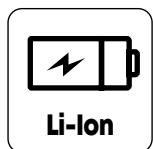

3.7V 2000 mAh

LED-395



Charge indicator:
5 green LED's, each showing 20% charge

Power button

Intensity control buttons (+) & (-) for worklight & top torch

Press & hold (+) to increase intensity of light

RUN TIME
3 hours (at full intensity)
20 hours (at lowest intensity)

MULTIPLE MODE OUTPUT

	1ST PRESS	2ND PRESS
	TOP TORCH	WORKLIGHT
LUMEN	180	350
RUN TIME	4 hours	3 hours



USB output port to charge mobile devices

ORDERING INFORMATION

CAT NR.	SIZE		BOX QTY.
	(INCH)	(MM)	
LED/395	7-9/32 × 2-3/8 × 1-17/64	185 × 60 × 32	50

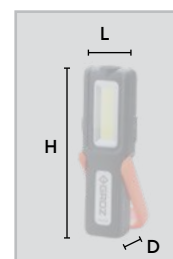
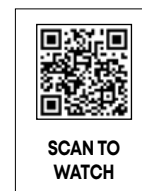

87

Worklight Intensity Control & Battery Display

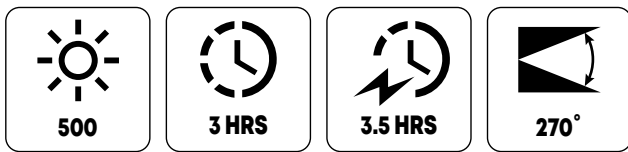



Multi-function, powerful worklight & top torch

Integrated

- 10W COB Worklight
- 3W LED Top Torch

Light Output

User controlled output. Adjust light intensity of worklight and top torch by pressing ON/OFF buttons continuously

		LUMEN	RUN TIME
1ST PRESS	TOP TORCH	150	3-3.5 hours
2ND PRESS	WORKLIGHT	500	2-3 hours
3RD PRESS	CONTINUOUS RED LIGHT		
4TH PRESS	RED FLASHING		

Durable Construction

- Impact proof & water resistant ABS body with rubber coating
- Integrated pocket/belt clip

Hands Free Operation

- Swivelling magnetic stand with magnet to position light on any metallic surface
- Magnet on clip can also be used to affix light on any metal surface

Charging of Battery

Battery can be recharged using a standard USB cable provided with the light

Charge Your Mobile Device

USB output port for use as power bank



POWER SOURCE

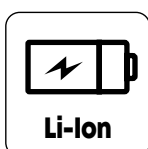

3.7V 2000 mAh

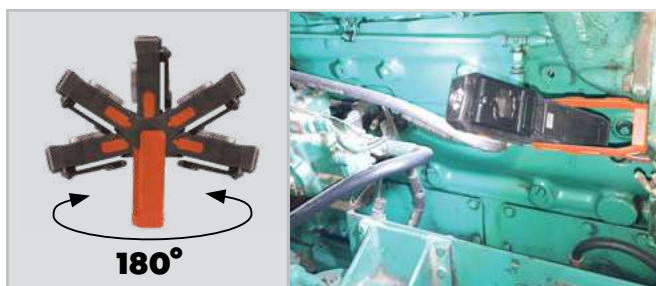

Swivelling Magnetic Stand: Swivel to adjust light to the required angle. Magnetic end to affix light on metallic surface for hands free use



USB output port to charge mobile devices



ORDERING INFORMATION

CAT NR.	SIZE		BOX QTY.
	(INCH)	(MM)	
LED/396	6-21/32 × 1-47/64 × 1-11/32	169×44×34	20

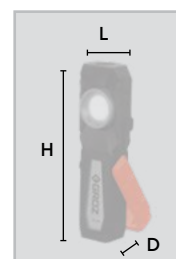

88

Worklight UV & Dual Charging

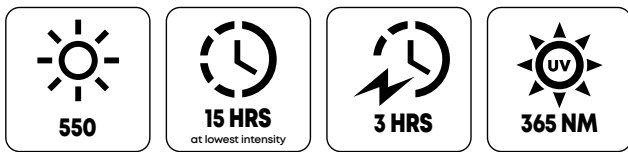

Multifunction, powerful worklight & UV spotlight in one.



Integrated

- 10W COB Worklight
- 3W UV light

Light Output

User controlled output: Adjust intensity of both worklight & spotlight by pressing on the increase (+) or decrease (-) button

Built-in memory function starts the light at the same intensity as when it was switched off

		LUMEN	RUN TIME
1ST PRESS	UV SPOT LIGHT	-	4-5 hours
2ND PRESS	WORKLIGHT	550	3-15 hours
3RD PRESS	CONTINUOUS RED LIGHT		
4TH PRESS	RED FLASHING		

Sturdy Construction

- Impact proof ABS body with rubber coating
- Sturdy polycarbonate lens to withstand the toughest of job site conditions
- Nylon hook with 360° rotating action

Swivel & tilt design

Patented 360° swivel & tilt mechanism.

Ball joint mechanism allows

- Swivelling of light full 360°
- Tilt

Hands Free Operation

Strong magnet on the base to mount light onto any metallic surface for hands free use

Type C fast charging

Wireless charging via

- Direct charging of light
- Docking station

Charge Your Phone

Rechargeable and removable battery pack also doubles up as a power bank



LED-376U

CE
RoHs



Hook

Aluminium
fins keep the
light cool

USB output
port



UV light for detecting engine oil leakage, gas leakage, crack in welding jobs in industrial, automotive, HVAC applications



Fully flexible 360° swivel & tilt design with unique ball joint



Charge Your Mobile Device
USB output port for use as power bank

POWER SOURCE

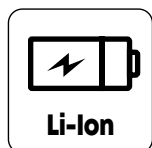

3.7V 2000 mAh

ORDERING INFORMATION

CAT NR.	SIZE (LxHxD)		BOX QTY.
	(INCH)	(MM)	
LED/376U	7-13/16 x 2-1/2 x 1-1/8	198 x 63 x 29	10

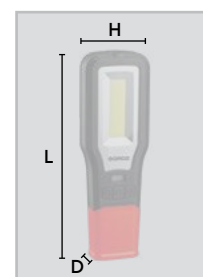

89

Folding Worklight Intensity Control

CE
RoHS



3 in 1 worklight with foldable design for difficult to reach & narrow workspaces

Integrated

- a. 4W COB Worklight
- b. 2W SMD Spotlight
- c. 0.5W SMD Top Torch with Magnetic pick-up

COB Worklight

Smart design ensures user controlled output. Adjust light intensity of worklight and spot light by pressing and holding the power button

Magnetic Top torch doubles as a pick-up tool to reach out into narrow holes & crevices

Sturdy Construction

- a. Aluminium body with ABS coating making it robust and impact proof
- b. Sturdy polycarbonate lens to withstand the toughest of job site conditions

c. Compact Folding Design

Fold into a pocket-sized light

Hands Free Operation

Super strong magnet on base help affix the light on any metallic surface leaving both hands free

Unique Clamping Base

Unique spring loaded clamping base to mount on any work surface for hands free usage

Charging of Battery

Type-C fast charging protected by rubberized bezel. Comes complete with USB cable. Charge indicated via 4 LED's, each showing 25% charge



POWER SOURCE

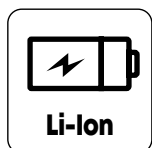

3.7V 2600 mAh

ORDERING INFORMATION

CAT NR.	SIZE (L×H×D)		BOX QTY.
	(INCH)	(MM)	
LED/185	1-13/16 × 6-1/4 × 1-7/32	46 × 158 × 31	12

LED-185



Press & hold the power button to increase/decrease the intensity of the main worklight

RUN TIME
3 hours
 (at full intensity)
10 hours
 (at lowest intensity)



Unique spring loaded clamping base to mount on any work surface

Multiple Mode Output

	MODE 1			MODE 2
	1ST PRESS	2ND PRESS	3RD PRESS	DOUBLE PRESS
	MAIN WORKLIGHT	RED LIGHT	TOP TORCH	SPOTLIGHT
LUMEN	400	-	50	150
RUN TIME	3-10 hours	20 hours	40 hours	10 hours



Magnetic Top torch doubles as a pick-up tool



90° pivoting action

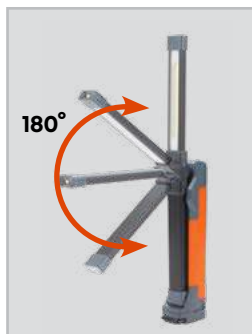

180° rotating main light folds back into a compact pocket size worklight

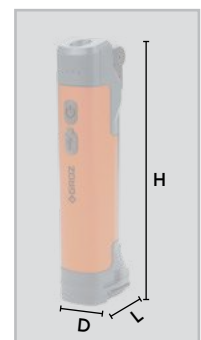

3-In-1 Quick Connect Worklight Kit

All in one rechargeable quick connect worklight kit

Main body with quick connect mechanism to easily change heads
Kit includes 3 interchangeable heads

- Flashlight
- Flexible Worklight with magnetic pick-up
- Foldable Worklight

User Controlled Output

Powerful multiple output with bright and balanced illumination

MODES	FLASHLIGHT		FLEXIBLE WORKLIGHT		FOLDABLE WORKLIGHT	
	LUMEN	RUN TIME	LUMEN	RUN TIME	LUMEN	RUN TIME
HIGH INTENSITY	700	2 hrs	200	5 hrs	500	3 hrs
MEDIUM INTENSITY	300	4 hrs	150	7 hrs	300	6 hrs
LOW INTENSITY	100	12 hrs	100	12 hrs	140	11 hrs
STROBE	○○○○○○○○		○○○○○○○○		○○○○○○○○	

Sturdy Construction

- IP 54 Rated**
Protected against dust and effects of water spray from any direction
- IK 07 Rated**
Impact proof & corrosion-resistant aluminium die-cast housing in premium powder-coated finish makes it resistant to shocks and vibration – common on any jobsite

Hands-Free Operation

Strong magnet on the base helps affix the light on any metallic surface leaving both hands free

Charging Of Battery

- Type C fast charging
- While charging, the indicator is red. Once fully charged indicator turns green

POWER SOURCE

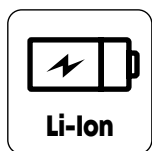

3.7 V 4000 mAh



1

10W LED Flashlight
Compact & sturdy aluminium & copper construction



2

3W LED Flexible Worklight with Magnetic Pick-up

- Heavy duty flexible gooseneck can be rotated & bent 360° horizontally & vertically
- Magnetic torch doubles up as a pickup tool



3

5W COB Foldable Worklight

- Slim worklight with 180° rotation of light
- Can rotate 360° horizontally for multi-angle illumination



LED-187

NEW! IP54
IK07



ON/OFF
button



**Quick Connect
Mechanism**
Easy replace head
in just 1 second!



Type-C Charge



ORDERING INFORMATION

CAT NR.	BOX QTY.
LED/187	10

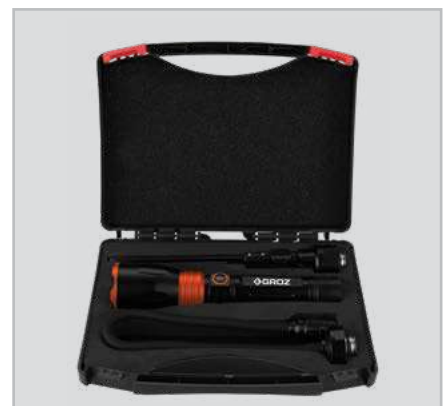

Comes in a easy to store and carry-blow moulded case

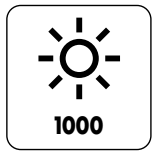

Integrated

Dual head worklight 5W COB on each side use both together or separately as needed

User controlled output

Adjust light intensity from 50-500 lumens (on each light) by rotating knob

	1ST PRESS	2ND PRESS	3RD PRESS
	FRONT WORKLIGHT	BACK WORKLIGHT	BOTH LIGHTS
LUMEN	500	500	1000
RUN TIME	2-16 hours	2-16 hours	1-8 hours

Sturdy Construction

a. IP 54 Rated

Protected against dust and effects of water spray from any direction

b. IK 07 Rated

Impact proof ABS body

- c. Sturdy polycarbonate lens to withstand the toughest of job site conditions
- d. Nylon hook with ratcheting mechanism can be rotated full 360° for convenient placement of light as required
- e. Built-in magnet on top of the light to pickup small metallic parts

Direct light as needed

Heavy-duty flexible neck can be rotated & bent 360° horizontally & vertically

Hands Free Operation

Strong magnet on base for direct attachment on any metallic surface

Charging of Battery

- Type C fast charging protected by rubberized bezel.
- Charge indicated by 3 LED's, each showing 33% of battery



Dual head worklight 5W COB on each side



CE
RoHS
IP54
IK07

Intensity control knob

Hook



ORDERING INFORMATION

CAT NR.	SIZE (L×H×D)		BOX QTY.
	(INCH)	(MM)	
LED/186	16-21/32 × 2-37/64 × 1-3/4	423 × 65.5 × 44.5	10

POWER SOURCE



3.7V 2600 mAh

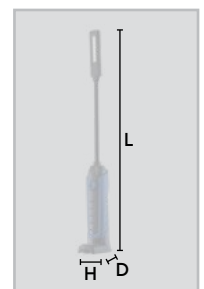

92

Worklight 360° Swivel

LED-360

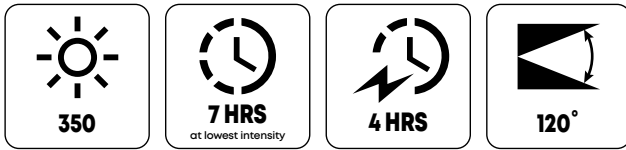

CE
RoHs
IP54
IK07

Multi-function, powerful worklight & spotlight in one

Integrated

- a. 7 SMD Worklight
- b. 3W LED Top Torch

Light Output

	LUMEN	RUN TIME	LUMEN	RUN TIME
INTENSITY	HIGH		LOW	
WORKLIGHT	350	3 hours	200	7 hours
TOP TORCH	120 lumen with a run time of 8 hours			

Sturdy Construction

- a. **IP 54 Rated**
Protected against dust and effects of water spray from any direction
- b. **IK 07 Rated**
Impact proof ABS body
- c. Sturdy polycarbonate lens to withstand the toughest of job site conditions
- d. Nylon hooks with ratcheting mechanism can be rotated full 360° for convenient placement of light

Swivel & tilt design

- Patented 360° swivel & tilt mechanism. Ball joint mechanism allows
- a. Swivelling of light full 360°
 - b. Tilt

Hands Free Operation

Three magnets; two on the rear of the light & one on the end, can be attached to any metallic surface leaving both hands free

Charging of Battery

Battery can be recharged using standard USB cable provided with the light

POWER SOURCE

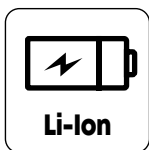

3.7V 2200 mAh

ORDERING INFORMATION

CAT NR.	SIZE (LxHxD)		BOX QTY.
	(INCH)	(MM)	
LED/360	10 x 2-9/32 x 1-57/64	254 x 58 x 48	12



Patented 360° swivel & tilt design with stainless steel ball joint



2 fold out 360° swivelling hooks for easy installation

93

Inspection Lamp Unbreakable

LED-345

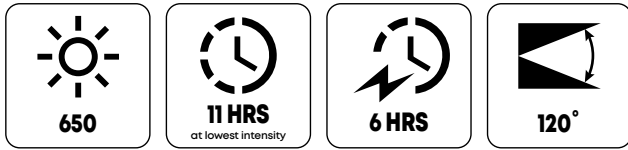

Light Output

Single button controlled variable output

INTENSITY	HIGH	MEDIUM	LOW
LUMEN	650	400	200
RUN TIME	4 hours	6 hours	11 hours

In-built overcharge/discharge control with automatic cut-off enhances battery life & performance

Construction

- a. Lightweight yet rugged aluminium tubing with TPR grip makes it impact resistant
- b. 2 ratcheting hooks with 360° swivel movement

Hands free usage

Removable clamp with magnetic end to attach light to any metallic surface leaving both hands free

Charging of Battery

Battery can be recharged using standard USB cable provided with the light

Charging level indicators clearly marked

- a. **GREEN:** Full Charge
- b. **RED:** Charging in process



POWER SOURCE

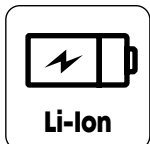

3.7V 4400 mAh

ORDERING INFORMATION

CAT NR.	SIZE (LxHxD)		BOX QTY.
	(INCH)	(MM)	
LED/345	18 x 3-3/16 x 2-49/64	458 x 81 x 70	10

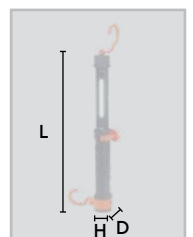

94

Underhood Light Magnetic Ends

LED-355

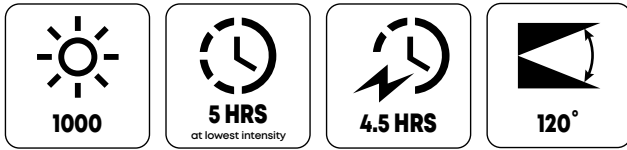

CE
RoHs
IK07

Slim & compact 10W COB underhood light, shines brighter & lasts longer

Light Output

Single button, user controlled light output

	1ST PRESS	2ND PRESS
	HIGH	LOW
LUMEN	1000	400
RUN TIME	2 hrs	5 hrs



Sturdy Construction

a. IK07 Rated

Impact resistant ABS body built to withstand the toughest environments

- b. 360° swivelling hooks resist wear and provide a scratch-proof grip
- c. Sturdy polycarbonate lens withstands tough jobsite conditions
- d. Light can be rotated easily to direct beam on the job, as required



Hands Free Operation

Strong magnets on both ends for easy attachment on any metallic surface leaving both hands free.

Hands free: Strong magnets on both ends attach onto metallic surfaces leaving both hands free

Charging of Battery

- Type-C fast charging protected by rubberized bezel.
- Charge indicated via 4 LED's, each showing 25% charge



Type C Charging Port

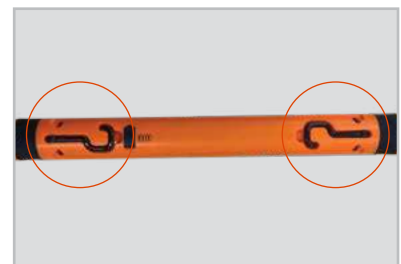

360° Swivelling Hooks

POWER SOURCE

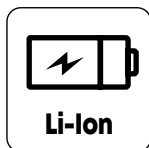

7.4V 2600 mAh

ORDERING INFORMATION

CAT NR.	SIZE (LxHxD)		BOX QTY.
	(INCH)	(MM)	
LED/355	19-11/16 x 1-31/32 x 1-39/64	500 x 50 x 41	10

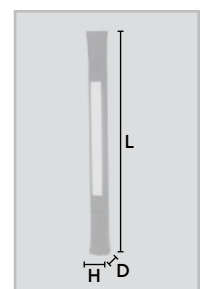

95

Underhood Light High Intensity - Glare Free

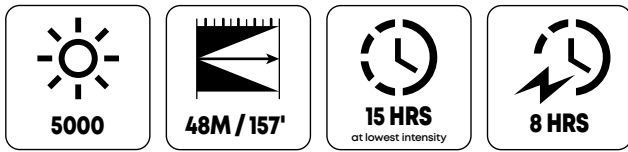

Expandable Length
1.2m -1.72m (46 - 1/2"-68")

World's First 5000 Lumen Underhood Light

Flicker-free and glare-free light ensures constant work output

Multi-Mode Output

Multiple mode output ensures user comfort

	1ST PRESS	2ND PRESS	3RD PRESS
	HIGH INTENSITY	MEDIUM INTENSITY	LOW INTENSITY
LUMEN	5000	2500	1000
RUN TIME	3 hrs	6 hrs	15 hrs

Sturdy Construction

- Aluminium extruded body
- Strong steel hooks with non-marring rubber coating
- Hooks can be conveniently rotated for firm grip

Expandable Length

Expandable length 1.2m–1.72m (46–1/2"–68") provides maximum utility for under-hood, undercarriage or over-dash applications

Charging of Battery

Battery can be recharged using in-built Type C charging port

Complete with 9' long cable for uninterrupted charging even when light is in use & AC power adaptor

POWER SOURCE

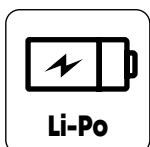

7.4V 5000 mAh

LED-353

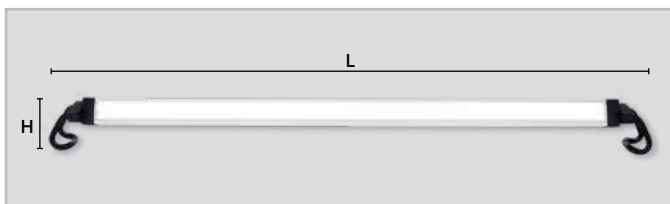

ORDERING INFORMATION

CAT NR.	SIZE (LxHxD)		BOX QTY.
	(INCH)	(MM)	
LED/353	46-1/2 x 2 x 3	1180 x 50 x 75	1

96

Spotlight Waterproof

LED-402



CREE
CE
RoHS
IP67

7W LED handheld spotlight & worklight
 7W CREE® LED, Xm-L2

Light Output

High quality, super-bright, focussed, user controlled multiple mode output

a. IP 67 Rated

Protected against dust & effects of water immersion upto 1 metre

b. Designed to float

- c. Shock proof & lightweight ABS body, rubber head & ergonomic TPR grip
- d. Shock-proof polycarbonate lens
- e. Waterproof trigger to control light modes
- f. Integrated fold out stand converts hand-held spot light into a worklight
- g. Lanyard with SOS whistle

Charging of Battery

Dual charging via

- a. AC supply
Charge Time: 4-5 hours
- b. Cigarette Charger
Charge Time: 3-4 hours



	1ST PRESS	2ND PRESS	3RD PRESS	4TH PRESS & HOLD
TYPE	HIGH INTENSITY	LOW INTENSITY	SOS FLASHING	RED FLASHING
LUMEN	700	350		
RUN TIME	2 hrs	4.5 hrs		

POWER SOURCE

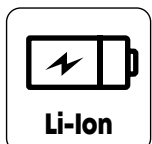

3.7V 2200 mAh



Floats in water



Integrated fold out stand converts hand held spotlight into a worklight

ORDERING INFORMATION

CAT NR.	BOX QTY.
LED/402	10



97

Pen Light UV and Laser

LED-175

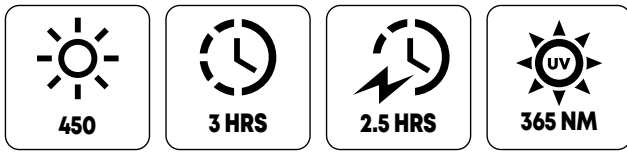

CE
RoHS

Power Packed Pen Light

Integrated

- 5W COB mainlight
- 3W LED spotlight
- UV light (365nm)
- Laser Pointer

LIGHT OUTPUT

User controlled output. Adjust light intensity of spotlight, mainlight & UV light by pressing & holding power button. Double press the laser ON/OFF button to activate the laser beam

	1ST PRESS	2ND PRESS	3RD PRESS	4TH DOUBLE PRESS
	SPOTLIGHT	MAINLIGHT	UV LIGHT	LASER LIGHT
LUMEN	140	450	-	-
RUN TIME	3 hours	2.5 hours		

Durable Construction

- Aluminum body with military grade anodised coating for enhanced durability.
- Integrated Pocket Clip adjustable 120° for directing light in desired direction.
- Magnet on clip can be used to affix light on any metallic surface

Built-in memory function

Starts light at the same intensity as when it was switched off

Charging of Battery

Battery can be recharged using a standard Type C cable provided with the light

POWER SOURCE

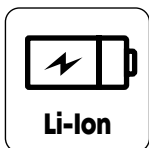

3.7V 800 mAh

ORDERING INFORMATION

CAT NR.	SIZE (L×H×D)		BOX QTY.
	(INCH)	(MM)	
LED/175	6-1/2 × 29/32 × 29/32	165 × 23 × 23	20

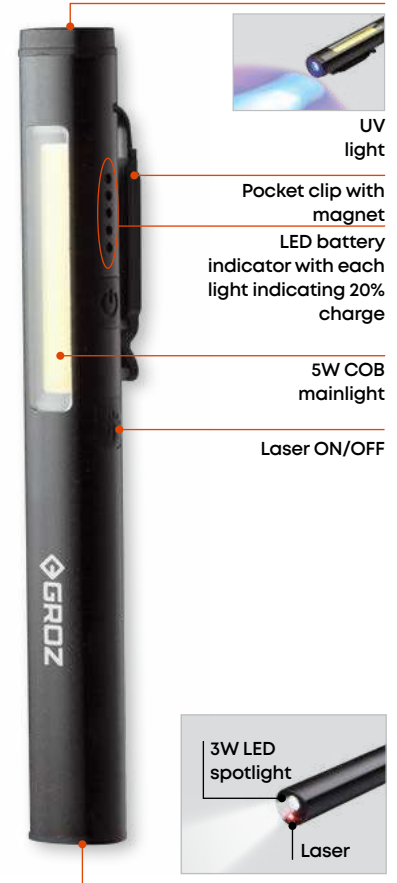

UV light for crack detection in industrial, automotive, HVAC applications & inspection purposes



Can be attached onto any metallic surface leaving both hands free





Super bright, dual function portable worklight & top torch

Integrated

- a. 3W COB Worklight
- b. 1W LED Top Torch

Light Output

High quality output in different modes

	MAIN LIGHT		TOP TORCH	
	LUMEN	RUN TIME	LUMEN	RUN TIME
FULL INTENSITY	180	3 hours	65	2 hours

Light Weight & Durable Construction

- c. Impact proof & water resistant ABS body with rubber coating
- d. Integrated Pocket Clip

Hands Free Use

Magnet on clip can be used to affix light on any metal surface

POWER SOURCE

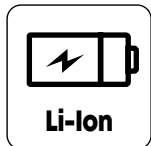

3.7V 800 mAh



85° Adjustable Pocket Clip with magnet to hook onto any magnetic surface

ORDERING INFORMATION

CAT NR.	SIZE (LxHxD)		BOX QTY.
	(INCH)	(MM)	
LED/335	7-9/32 x 1-25/64 x 13/16	185 x 35 x 20	50

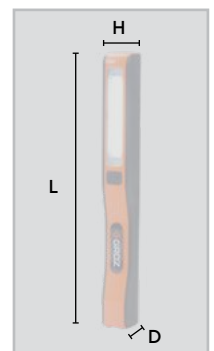

99

Penlight Pivoting Head

LED-160

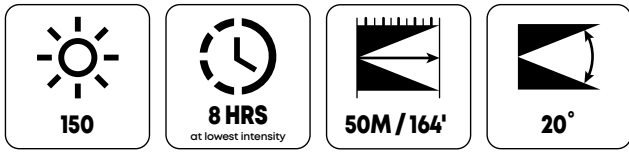

CE
RoHS
IP54
IK07

Slim pen light designed for the professional user

Light Output

Multiple modes with just the press of a button

Robust Construction

- a. **IP 54 Rated**
Protected against dust and effects of water spray from any direction
- b. Robust aluminium body with military grade anodised coating for enhanced durability
- c. Non-slip knurled grip
- d. Integrated pocket clip for easy and safe portability

Unique L-Head Design

Head can be turned 90° giving the user freedom to direct light beam as required

Hands Free Operation

Super strong magnet at the rear end can be affixed onto any metallic surface leaving both hands free

Runs on 2 × AAA drycell batteries

POWER SOURCE

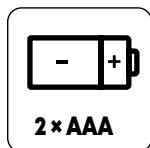

(not included)

Multiple Mode Output

	1ST PRESS	2ND PRESS	3RD PRESS & HOLD	4TH PRESS
	HIGH INTENSITY	LOW INTENSITY	QUICK FLASHING	SOS FLASHING
LUMEN	150	60		
RUN TIME	2.5 hrs	8 hrs		

ORDERING INFORMATION

CAT NR.	SIZE (L×H×D)		BOX QTY.
	(INCH)	(MM)	
LED/160	6 × 19/32 × 45/64	152 × 15 × 17.5	36

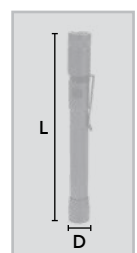

100 Pick-Up Light Telescopic

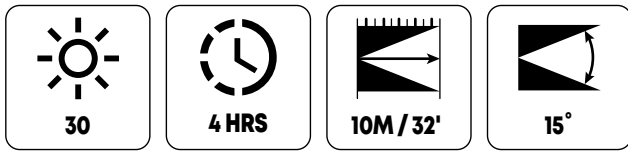

Dual Purpose Light

High quality 0.5W flashlight with magnetic telescopic pick up

Light Output

Focused light beam of 30 lumen helps reach out in dark areas

Robust Construction

- a. Durable aluminium body
- b. Flexible telescopic design to reach out into narrow holes & crevices
- c. Magnet at the front end to pick up small metallic parts
- d. Adjustable focus to direct light beam as per need
- e. Integrated pocket

Hands Free Use

Magnet at the rear end of light can be affixed onto any metallic surface leaving both hands free

Runs on 4 x 1.5LR44 drycell batteries (included)



POWER SOURCE

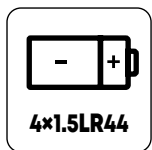

ORDERING INFORMATION

CAT NR.	BOX QTY.
LED/131	50



USB Charging: Simply connect the light to wall charger, laptop etc. for convenient charging



101 Flashlight Slim Pocket Size

LED-140

150

4 HRS

180°

CE
RoHS

Handy pocket flashlight

- Durable Construction**
- Impact proof & water resistant ABS body in matte black finish
 - Integrated pocket clip

Hands Free Operation
Magnet on clip can also be used to affix light on any metal surface



HANDS FREE USE



Can be hooked onto a pocket or belt for easy mobility & hands free use



Magnetic clip to attach light to any metallic surface for hands free usage

POWER SOURCE

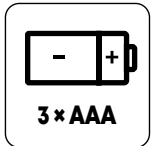

ORDERING INFORMATION

CAT NR.	SIZE (LxHxD)		BOX QTY.
	(INCH)	(MM)	
LED/140	4-11/32 x 1-3/16 x 23/32	110 x 55 x 21	24



NEW!
IK07



Dual head 3W LED Necklight

Built to be worn comfortably around the neck for easy usage

Light Output

Both heads equipped with individual ON/OFF button. Adjust light intensity by pressing and holding the ON/OFF button

	LIGHT 1	LIGHT 2	BOTH LIGHTS
LUMEN	150	150	300
RUN TIME	2-10 hours	2-10 hours	2-10 hours

Sturdy Construction

a. IK 07 Rated

Impact proof and corrosion resistant aluminium body with ABS housing that resists shock and vibrations – common on any jobsite

- b. Ergonomic neck band that rests comfortably on the neck without leaving any sweat marks

Useful for

- Mechanics
- HVAC Technicians
- Electricians
- Plumbers
- Camping & Hiking

Versatile Use

1. Wear around the neck while working in confined spaces
2. Attached to any metallic surface using the magnetic base
3. On tripod stand to light overhead work

Charging of Battery

- Type-C fast charging protected by a rubberized bezel
- Charge indicated via LED that turns red when power is low and turns green when battery is fully charged



ORDERING INFORMATION

CAT NR.	BOX QTY.
LED/145	20

POWER SOURCE

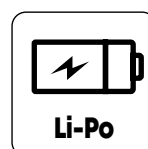

3.7V 2000 mAh

103

Flashlight Superbright

LED-191



Pocket sized, rechargeable high power flashlight with laser

Multiple mode output

Press and hold the power button (at any press) to increase the light intensity to 1200 Lumens of the mainlight

	INTENSITY	LUMEN	RUN TIME
1ST PRESS	HIGH	900	1.5 hours
2ND PRESS	MEDIUM	600	5.5 hours
3RD PRESS	LOW	80	10 hours
PRESS & HOLD	LASER		

Sturdy Construction

- Corrosion resistant aluminium alloy construction
- IPX6 Rated:** protected against effect of water spray from any direction

Hands Free Use

Strong magnet at the base and clip makes it easy to mount light on any metallic surface leaving both hands free

Charging of Battery

Type-C fast charging protected by rubberized bezel.

NEW!

CE
IPX6



POWER SOURCE

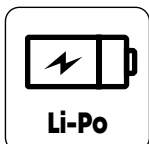

3.7V 2000 mAh



Pocket clip for hands free operation



Type-C charging port

ORDERING INFORMATION

CAT NR.	SIZE (L×H×D)		BOX QTY.
	(INCH)	(MM)	
LED/191	4-17/32 × 1-13/16 × 1-1/32	115 × 46 × 26	20

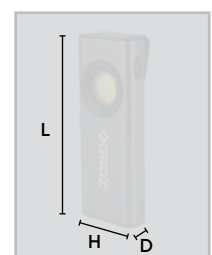

104

Worklight Slim Line

LED-337

NEW!



Slim & compact 3W COB worklight designed for inaccessible spaces

Light Output

Single button, user controlled light output

	1ST PRESS	2ND PRESS	3RD PRESS
	HIGH	LOW	STROBE
LUMEN	360	180	
RUN TIME	3.5 hours	8 hours	

Sturdy Construction

- Lightweight aluminium body with polycarbonate lens to withstand toughest conditions
- Hanging hook on top for hands free operation
- Enhanced with circuit protection which prevents battery from overcharging and complete discharging

Hands Free Operation

Strong magnets at back for easy attachment on any metallic surface leaving both hands free

Charging of Battery

- Type-C fast charging protected by rubberized bezel
- Battery Indicator - Red while charging & green once fully charged

POWER SOURCE

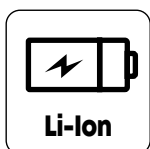

3.7 V 1800 mAh

ORDERING INFORMATION

CAT NR.	BOX QTY.
LED/337	20

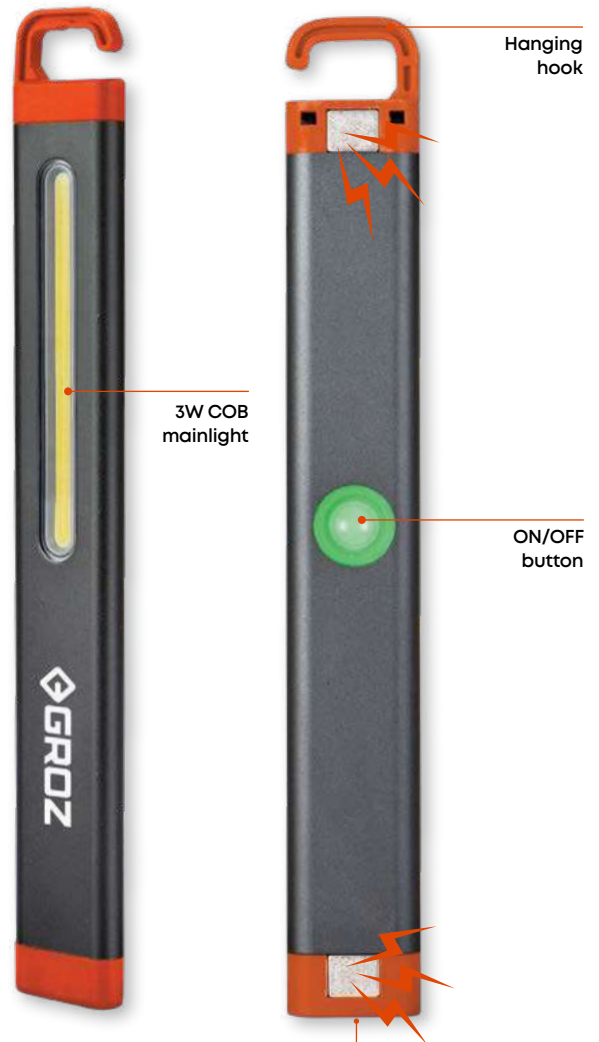

Hanging hook

3W COB mainlight

ON/OFF button



Type-C charging port



105

Worklight Multiple Functions

LED-176



NEW!
IP54
IK07

Flashlight with multiple functions – Ideal for use in automotive repair work, roadside emergencies, construction sites, camping etc.

Integrated

- a. 30W SMD flashlight
- b. 8W LED worklight

Pull to adjust focus of flashlight can be used as a spot or flood beam

Multiple Mode Output

Flashlight

	1ST PRESS	2ND PRESS	3RD PRESS
	HIGH	LOW	QUICK FLASHING
LUMEN	800	200	
RUN TIME	2 hours	6 hours	

Lantern Light (Long Press To Change Mode)

	1ST PRESS	2ND PRESS	3RD PRESS	4TH PRESS
	LOW	MEDIUM	HIGH	RED FLASHING
LUMEN	60	150	200	
RUN TIME	6 hours	3 hours	2 hours	

Charging of Battery

Type-C fast charging

Charge indicated via 4 LED's, each showing 25% charge

Charge Your Phone

In-built power bank

POWER SOURCE

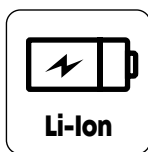

3.7 V 2800 mAh

ORDERING INFORMATION

CAT NR.	BOX QTY.
LED/176	10



30W SMD Flashlight

8W LED
Lantern Light

MULTIPLE MODE LANTERN LIGHT



Medium Intensity

Red Flashing

FOCUS FUNCTION

Pull to adjust focus as needed



Spot Beam

Flood Beam



Powerful 3W COB head lamp

User controlled multiple modes

	NORMAL MODE			SENSOR MODE
	1ST PRESS	2ND PRESS	3RD PRESS	PRESS & HOLD
	High Intensity	Low Intensity	Quick Flashing	High Intensity
LUMEN	150	35		150
RUN TIME	4 hours	12 hours		4 hours



Innovative & Unique Design

- a. Detachable Design: Light can be separated from head band and used as a worklight
- b. In-built sensor function with hands free ON/OFF. Wave to activate/deactivate light



Hands Free Sensor:
Wave to activate/
deactivate light

Ergonomic Construction

- a. Impact proof ABS
- b. Black woven head band with built-in protection pad
- c. Light attached to head band with a strong & powerful magnet
- d. Light can be easily rotated to focus at required angle

Charging of Battery

Battery can be recharged using a standard USB cable provided with the light



Detachable Design

The light is attached to the head band with the help of a magnet



Rotate light to focus at required angle

POWER SOURCE

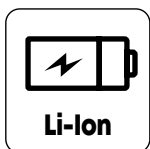

3.7V 2200 mAh

ORDERING INFORMATION

CAT NR.	BOX QTY.
LED/220	24



SCAN TO
WATCH

107

Headlamp Dual Mode & Hand Sensor

LED-225



CE
RoHS

Integrated

- 3W COB Floodlight
- 4W LED Spotlight

User controlled multiple mode

	1ST PRESS	2ND PRESS	3RD PRESS	4TH PRESS
	LED SPOTLIGHT		COB FLOODLIGHT	LED+COB COMBINATION
	HIGH INTENSITY	LOW INTENSITY	HIGH INTENSITY	HIGH INTENSITY
LUMEN	400	120	200	500
RUN TIME	2 hours	10 hours	4 hours	1.2 hours



Innovative & Unique Design

- Detachable Design: Light can be separated from head band and used as a Worklight
- Smart design ensures user controlled output. Adjust light intensity in all modes by simple press and hold of the power button

Sturdy Construction

- Impact proof ABS
- Black woven head band with built-in protection pad
- Light attached to head band with a strong & powerful magnet

Dual Power Source

Never run out of power - Use with the inbuilt rechargeable battery or insert dry cell batteries to keep the light on.

Charging of Battery

Charge light directly or just the lithium power batteries separately

POWER SOURCE

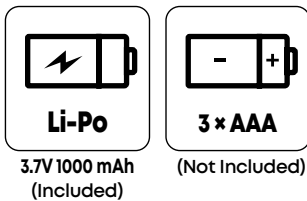

Detachable Design
The light is attached to the head band with the help of a magnet



Rotate light to focus as required

ORDERING INFORMATION

CAT NR.	BOX QTY.
LED/225	25



SCAN TO WATCH

108

Headlamp High Powered Strip Light

LED-250HP-UV

NEW!



Up your visibility game!

Engineered for versatility, this multi-mode headlamp lights up all directions over long distances

Integrated:

1. 5W COB wide angle Floodlight
2. 3W LED Spotlight
3. UV Light (365 Nm)

Light Output

Front COB LED panel for ultra wide-view flood beam giving 230° coverage and side spotlight for lighting up distances upto 45m/150'.

Single button controlled output in multiple modes

	1ST PRESS	2ND PRESS	3RD PRESS	4TH PRESS
	COB LIGHT		SPOTLIGHT	UV LIGHT 365 NM
	HIGH INTENSITY COB	LOW INTENSITY COB	HIGH INTENSITY	
LUMEN	500	200	70	-
RUN TIME	2 hours	4 hours	4 hours	-

Sensor Function

In-built sensor function for hands free ON/OFF of light. Wave to activate/deactivate light. Sensor can be activated in all modes

Durable Construction

Impact resistant construction: withstands falls upto 2m (6.5'). Highly Durable and stretchable headband.

Charging of battery

Type-C fast charging, protected by a rubber bezel.



Hands Free Sensor: Wave to activate/deactivate light



POWER SOURCE

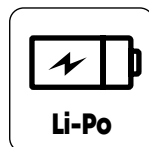

3.7V 1200 mAh

ORDERING INFORMATION

CAT NR.	ORD NR.	BOX QTY.
LED/250HP/UV	55125	40

109

**Floodlight
12W**

LED-505

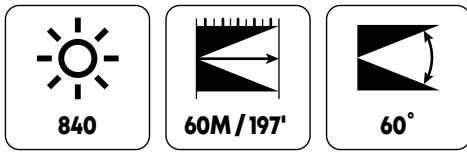

CREE

**CE
RoHs
IP67**

12W LED Floodlight

4 Powerful LED's of 3W each

Light Output

High quality output of 840 lumen with a spread of 60° over a distance up to 60 meter

Weather Proof Construction

a. IP67 Rated

- Protected against dust and effects of water immersion up to 1 meter
- b. Corrosion resistant aluminium die cast construction in premium powder coated finish
- c. Sturdy polycarbonate lens to withstand the toughest of job site conditions
- d. Corrosion resistant stainless steel bracket

Complete with 8" (200 mm) DC power cord

Ideal for Outdoor Use

Use on off-road vehicles, construction equipment, tractors, farm machinery, service vans, on mining sites etc.



POWER SOURCE

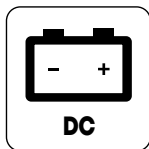

10V - 30V



ORDERING INFORMATION

CAT NR.	SIZE (LxHxD)		BOX QTY.
	(INCH)	(MM)	
LED/505	3-5/32 x 3 x 3-7/32	80 x 75 x 82	20

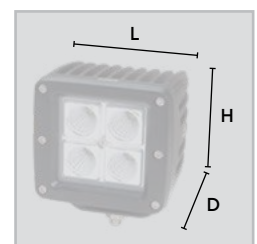

110

Floodlight 15W

LED-501

LED-502

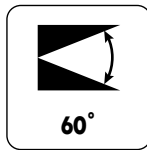
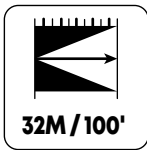
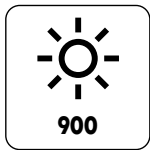

CE
RoHS
IP67

15W LED Floodlight

5 powerful LED's of 3W each

Light Output

High quality output of 900 lumen with a powerful flood spread of 60° over a distance up to 10 meter

Weather Proof Construction

a. IP 67 Rated

Protected against dust and effects of water immersion up to 1 meter

- b. Corrosion resistant aluminium
- c. die-cast construction in premium powder coated finish
- d. Sturdy polycarbonate lens to withstand the toughest of job site conditions
- e. Corrosion resistant stainless steel bracket

Complete with 20" (500mm) DC power cord

Available as a single piece or set of two

Ideal for Outdoor Use

Use on off-road vehicles, construction equipment, tractors, farm machinery, service vans, on mining sites etc.



POWER SOURCE

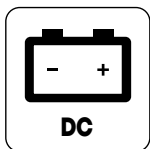

10V - 30V



ORDERING INFORMATION

CAT NR.	DESCRIPTION	SIZE (L×H×D)		BOX QTY.
		(INCH)	(MM)	
LED/501	Single Piece	3-11/32 × 3-11/32 × 1-3/8	85 × 85 × 35	27
LED/502	Set of Two	3-11/32 × 3-11/32 × 1-3/8	85 × 85 × 35	13





Floodlight 15W Compact

LED-501S

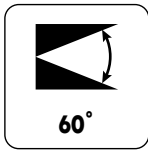
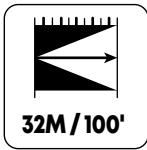
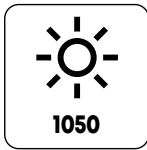

CE
RoHs
IP67

15W LED Floodlight

5 powerful LED's of 3W each

Light Output

High quality output of 1050 lumen with a powerful flood spread

Weather Proof Construction

a. IP 67 Rated

Protected against dust and effects of water immersion up to 1 meter

b. Corrosion resistant aluminium die-cast construction in premium powder coated finish

c. Sturdy polycarbonate lens to withstand the toughest of job site conditions

d. Corrosion resistant stainless steel bracket

Ideal for Outdoor Use

Use on off-road vehicles, construction equipment, tractors, farm machinery, service vans, on mining sites etc.



Die cast aluminium housing

Polycarbonate lens

Stainless steel bracket



POWER SOURCE

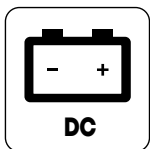

10V - 30V

ORDERING INFORMATION

CAT NR.	SIZE (L×H×D)		BOX QTY.
	(INCH)	(MM)	
LED/501S	2-29/32 × 2-29/32 × 1-3/8	74 × 74 × 35	27



112

Floodlight 15W Super Cool

LED-520

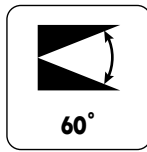
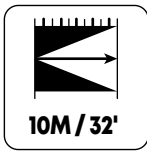
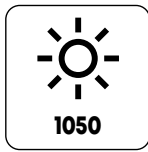

IP67

15W LED Floodlight

5 powerful LED's of 3W each

Light Output

Super cool light offers high quality output of 1050 lumen with a powerful flood spread of 60° over a distance up to 10 meter

Weather Proof Construction

a. IP 67 Rated

Protected against dust and effects of water immersion up to 1 meter

- b. Corrosion resistant aluminium die-cast construction in premium powder coated finish
- c. Sturdy polycarbonate lens to withstand the toughest of job site conditions
- d. Tight rubber sealing prevents ingress of dust and moisture
- e. Corrosion resistant stainless steel bracket

Complete with 20" (500mm) DC power cord

Ideal for Outdoor Use

Use on off-road vehicles, construction equipment, tractors, farm machinery, service vans, on mining sites etc.



POWER SOURCE

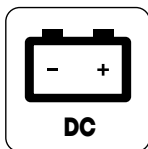

12V - 60V

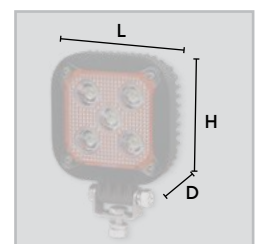

ORDERING INFORMATION

CAT NR.	SIZE (LxHxD)		BOX QTY.
	(INCH)	(MM)	
LED/520	4 x 4-13/16 x 1-7/8	101 x 122 x 48	12

113

Floodlight 18W Super Cool

LED-530

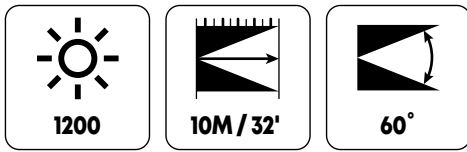

CREE 
IP67

The most versatile floodlight for any application

18W LED Floodlight

6 powerful LED's of 3W each

Light Output

Super cool light offers high quality output of 1200 lumen with a powerful flood spread of 60° over a distance up to 10 meter

Weather Proof Construction

a. IP67 Rated

Protected against dust and effects of water immersion up to 1 meter

- b. Corrosion resistant aluminium die-cast construction in premium powder coated finish
- c. Sturdy polycarbonate lens to withstand the toughest of job site conditions
- d. Tight rubber sealing prevents ingress of dust and moisture
- e. Corrosion resistant stainless steel bracket



Complete with 20" (500mm) DC power cord

Ideal for Outdoor Use

Use on off-road vehicles, construction equipment, tractors, farm machinery, service vans, on mining sites etc.

POWER SOURCE

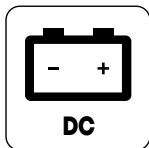

12V - 60V



Directs light beam to required direction

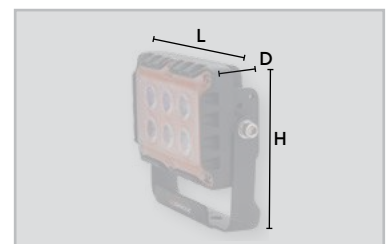

ORDERING INFORMATION

CAT NR.	SIZE (L×H×D)		BOX QTY.
	(INCH)	(MM)	
LED/530	4-9/32 × 5 × 1-21/32	109 × 127 × 42	12

114

Floodlight 27W

LED-512

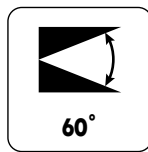
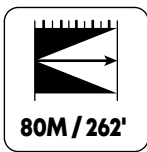
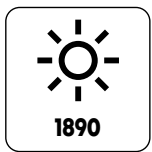

High output, super bright illumination over long distances

27W LED Floodlight

9 powerful LED's of 3W each

Light Output

High quality output of 1890 lumen with a powerful flood spread of 60° over a distance up to 80 meter

Weather Proof Construction

a. IP 67 Rated

Protected against dust and effects of water immersion up to 1 meter

- b. Corrosion resistant aluminium die- cast construction in premium powder coated finish
- c. Sturdy polycarbonate lens to withstand the toughest of job site conditions
- d. Corrosion resistant stainless steel bracket

Complete with 18" (450mm) DC power cord

Ideal for Outdoor Use

Use on off-road vehicles, construction equipment, tractors, farm machinery, service vans, on mining sites etc.

POWER SOURCE

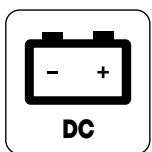

9V - 32V

ORDERING INFORMATION

CAT NR.	SIZE (LxHxD)		BOX QTY.
	(INCH)	(MM)	
LED/512	4-1/4 x 4-1/4 x 2-27/32	108 x 108 x 72	20

CREE

CE
RoHS
IP67



115

**Floodlight
30W**

LED-545

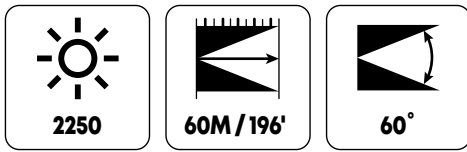

CREE
CE
RoHs
IP67

High output super bright floodlight for 'On-the-Go' use

30W LED Floodlight

6 powerful LED's of 5W each

Light Output

High quality output of 2250 lumen with a powerful flood spread of 60° over a distance up to 60 meter

Weather Proof Construction

a. IP 67 Rated

Protected against dust and effects of water immersion up to 1 meter

b. Corrosion resistant aluminium die-cast construction in premium powder coated finish

c. Sturdy polycarbonate lens to withstand the toughest of job site conditions

d. Corrosion resistant stainless steel bracket

Complete with 8" (200mm) DC power cord

Ideal for Outdoor Use

Use on off-road vehicles, construction equipment, tractors, farm machinery, service vans, on mining sites etc.



POWER SOURCE

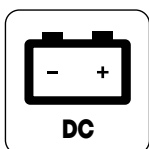

9V - 32V

ORDERING INFORMATION

CAT NR.	SIZE (LxHxD)		BOX QTY.
	(INCH)	(MM)	
LED/545	6 x 2-1/16 x 2-9/32	150 x 52.5 x 56	20



116

Floodlight 45W

LED-541

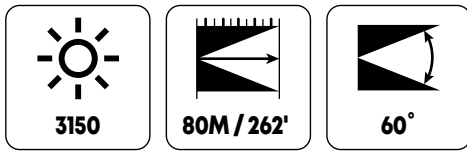

CE
RoHS
IP67

High output super bright floodlight for long distance visibility

45W LED Floodlight

15 powerful LED's of 3W each

Light Output

High quality output of 3150 lumen with a powerful flood spread of 60° over a distance up to 80 meter

Weather Proof Construction

a. IP 67 Rated

Protected against dust and effects of water immersion up to 1 meter

- b. Corrosion resistant aluminium die-cast construction in premium powder coated finish
- c. Sturdy polycarbonate lens to withstand the toughest of job site conditions
- d. Corrosion resistant stainless steel bracket

Complete with 18" (450mm) DC power cord

Ideal for Outdoor Use

Use on off-road vehicles, construction equipment, tractors, farm machinery, service vans, on mining sites etc.



POWER SOURCE

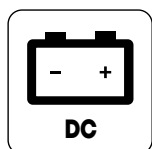

9V - 32V



ORDERING INFORMATION

CAT NR.	SIZE (LxHxD)		BOX QTY.
	(INCH)	(MM)	
LED/541	6-7/32 x 3-23/32 x 3	158 x 95 x 75	12

T17

Floodlight 48W

LED-515

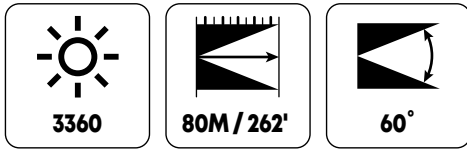

CE
RoHS
IP67

Brightest floodlight on site

48W LED Floodlight

16 powerful LED's of 3 W each

Light Output

High quality output of 3360 lumen with a powerful flood spread up to 60° wide and over a distance up to 80 meter

Weather Proof Construction

a. IP 67 Rated

Protected against dust and effects of water immersion up to 1 meter

- b. Corrosion resistant aluminium die-cast construction in premium powder coated finish
- c. Sturdy polycarbonate lens to withstand the toughest of job site conditions
- d. Corrosion resistant stainless steel bracket

Complete with 18" (450mm) DC power cord

Ideal for Outdoor Use

Use on off-road vehicles, construction equipment, tractors, farm machinery, service vans, on mining sites etc.



POWER SOURCE

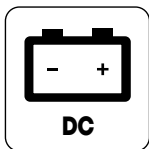

9V - 32V

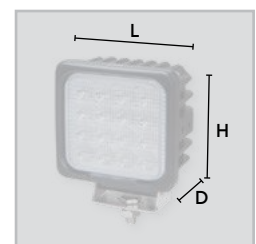

ORDERING INFORMATION

CAT NR.	SIZE (LxHxD)		BOX QTY.
	(INCH)	(MM)	
LED/515	4-1/4 x 5-13/32 x 2-27/32	108 x 138 x 72	20

118

Light Bar 36W

LED-701

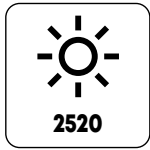

36W LED Light Bar
12 powerful LED's of 3W each

Light Output
High quality output of 2520 lumen

Combination Beam
Floodlight & spotlight in one; powerful flood spread & concentrated bright spot illumination are ideal for projecting light to long distances & keeping surrounding areas bright

- Weather Proof Construction**
- a. **IP 67 Rated**
Protected against dust and effects of water immersion up to 1 meter
 - b. Corrosion resistant aluminium extruded housing in premium powder coated finish
 - c. Sturdy polycarbonate lens to withstand the toughest of job site conditions

Complete with 20" (500mm) DC power cord

Ideal for Outdoor Use
Use on off-road vehicles, roof top of ATV's, UTV's, construction equipment, tractors, farm machinery, SUV's etc

POWER SOURCE

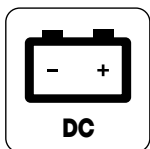

10V - 30V

ORDERING INFORMATION

CAT NR.	SIZE (L×H×D)		BOX QTY.
	(INCH)	(MM)	
LED/701	8 × 4-17/32 × 3-11/32	204 × 115 × 85	12

CREE
CE
RoHS
IP67



COMBINATION BEAM

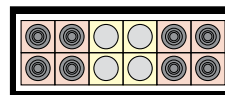

- FLOODLIGHT
- SPOTLIGHT

	FLOODLIGHT	SPOTLIGHT	FLOODLIGHT
	60°	30°	60°
	100M (328')	200M (656')	100M (328')

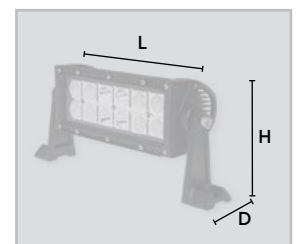

119

Light Bar 72W

LED-711

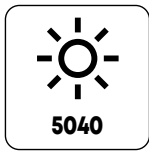

72W LED Light Bar

24 powerful LED's of 3W each

Light Output

High quality output of 5040 lumen

Combination Beam

Floodlight & spotlight in one; powerful flood spread & concentrated bright spot illumination are ideal for projecting light to long distances & keeping surrounding areas bright

Weather Proof Construction

a. IP 67 Rated

Protected against dust and effects of water immersion up to 1 meter

b. Corrosion resistant aluminium extruded housing in premium powder coated finish

c. Sturdy polycarbonate lens to withstand the toughest of job site conditions

Complete with 20" (500mm) DC power cord

Ideal for Outdoor Use

Use in mining applications, on off-road vehicles, roof top of ATV's, UTV's, construction equipment, tractors, farm machinery, SUV's etc.

POWER SOURCE

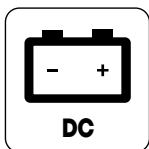

10V - 30V

ORDERING INFORMATION

CAT NR.	SIZE (LxHxD)		BOX QTY.
	(INCH)	(MM)	
LED/711	14 x 4-17/32 x 3-11/32	357 x 115 x 85	12

CREE

CE
RoHs
IP67



COMBINATION BEAM

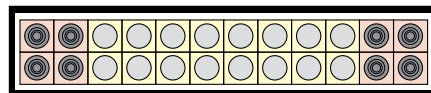

FLOODLIGHT

SPOTLIGHT

	FLOODLIGHT	SPOTLIGHT	FLOODLIGHT
	60°	30°	60°
	100 (328')	200 (656')	100 (328')

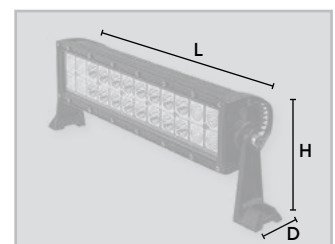

120

Light Bar 120W

LED-721

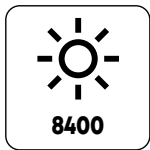

120W LED Floodlight

40 powerful LED's of 3W each

Light Output

High quality output of 8400 lumen

Combination Beam

Floodlight & spotlight in one; powerful flood spread & concentrated bright spot illumination are ideal for projecting light to long distances & keeping surrounding areas bright

Weather Proof Construction

a. IP 67 Rated

Protected against dust and effects of water immersion up to 1 meter

b. Corrosion resistant aluminium extruded housing in premium powder coated finish

c. Sturdy polycarbonate lens to withstand the toughest of job site conditions

Complete with 20' (500mm) DC power cord

Ideal for Outdoor Use

Use in mining applications, on off-road vehicles, roof top of ATV's, UTV's, construction equipment, tractors, farm machinery, SUV's etc

POWER SOURCE

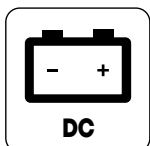

10V - 30V

ORDERING INFORMATION

CAT NR.	SIZE (LxHxD)		BOX QTY
	(INCH)	(MM)	
LED/721	22-1/8 x 4-17/32 x 3-11/32	562 x 115 x 85	6

CREE

CE
RoHS
IP67



270°
Rotation

COMBINATION BEAM

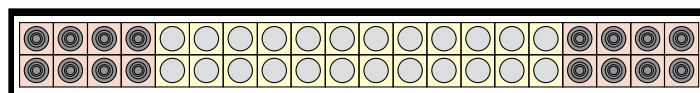

FLOODLIGHT
 SPOTLIGHT

	FLOODLIGHT	SPOTLIGHT	FLOODLIGHT
	60°	30°	60°
	100 (328')	200 (656')	100 (328')

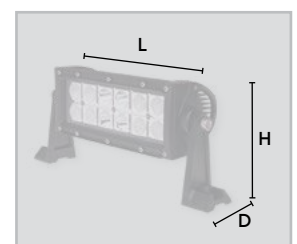



03

**FLUID
HANDLING**

121

The Ultimate Lever Grease Gun

K45

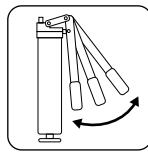

High capacity - high output lever grease gun

Reduce greasing time to one-half

30% larger dia pistons pushes out 50% more grease /stroke than regular guns

Aluminum die cast head fitted with bulk loader valve

Heavy gauge drop resistant steel barrel in premium metallic powder coated finish

Variable Stroke

Convenient greasing in tight spaces with limited movement of handle

High compression spring for removing air pockets from grease

Fully serviceable with no riveted parts

Works with NLGI 1, 2 & 3 greases

Complete with

150 mm rigid steel extension & 3 jaw coupler



Heavy duty aluminium head

Drop resistant large capacity steel barrel

ORDERING INFORMATION

CAT NR.	CAPACITY		BOX QTY.
	BULK		
G19R/N	650 gms	16	

122

Lever Grease Gun Heavy Duty

G1-HD

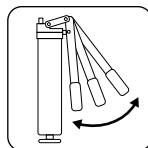

Designed for heavy industrial applications

Solid aluminium grease gun head fitted with air bleeder & bulk loader valves

1.2 mm thick steel barrel with heavy duty follower spring, CNC machined head & rolled threads for fast & easy reloading

Unique Lock Lever Mechanism

Allows user to easily lock plunger rod in any position

Variable Stroke

Convenient greasing in tight spaces with limited movement of handle

Resists back pressure, especially useful in chain tightening of earth moving equipment

Complete with

150 mm rigid steel extension & 4 jaw coupler



Ergonomic rubber grip

Unique lock lever mechanism

ORDERING INFORMATION

CAT NR.	CAPACITY		BOX QTY.
	BULK	CARTRIDGE	
G1R/HD/B	500 gms	400 gms	16

123 **Lever Grease Gun Dual Piston** **G2**



3X ADVANTAGE
Reduce Greasing Time To One-Third!

The high output greasing solution for applications requiring voluminous and frequent greasing

Built Tough

- Dual piston design 3X output of grease per stroke
- Barrel with 0.049" (1.2 mm) wall thickness
- Heavy duty follower spring
- High tolerance CNC machined Aluminium die-cast head with air release valve
- Rolled threads for quick and easy reloading

Reduce Greasing Time To One-Third

Dual piston mechanism results in triple output per stroke reducing greasing time to one-third

No Loss of Prime

Dual inlet of grease ensures that gun does not lose prime

Convenience of Use

Even in extreme cold weather conditions

Complete with 150 mm rigid steel extension and coupler



ORDERING INFORMATION

CAT NR.	CAPACITY		BOX QTY.
	BULK	CARTRIDGE	
G2R/B	500 gms	400 gms	16



124

**Lever Grease Guns
Heavy Duty - V Series**

V1-HD



Professional model - ideal for lubrication in automotive workshops, agricultural & light industrial application

Aluminium die cast grease gun head with built-in air bleeder valve

Robust steel barrel with knurling for firm grip

Heavy duty handle with ergonomic non slip soft rubber grip

Complete with

150 mm rigid steel extension & 4 jaw coupler

ORDERING INFORMATION

CAT NR.	FINISH	CAPACITY		BOX QTY.
		BULK	CARTRIDGE	
V1R/HD/CP/B	Zinc Plated	500 gms	400 gms	16
V1R/HD/BL/B	Powder Coated	500 gms	400 gms	16



125

**Lever Grease Gun
'V' Series**

V1



21st century design – ideal combination of superior quality & value price

Suitable for use in general lubrication & daily maintenance work

Aluminium die cast grease gun head with built-in air release valve

Soft rubber grip on lever handle for comfortable operation

Durable powder coated finish

Complete with

150 mm rigid steel extension & 4 jaw coupler

ORDERING INFORMATION

CAT NR.	CAPACITY		BOX QTY.
	BULK	CARTRIDGE	
V1R/B	500 gms	400 gms	16



126 Lever Grease Gun Super Value G1

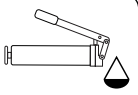

1GM / STROKE



6,000 PSI

Most popular value priced grease gun - for general purpose lubrication across all sorts of applications

Drop resistant steel head with a bulk loader valve

Soft rubber grip on lever handle for comfortable use

Durable powder coated finish

Complete with

150 mm rigid steel extension & 4 jaw coupler



ORDERING INFORMATION

CAT NR.	CAPACITY		BOX QTY.
	BULK	CARTRIDGE	
G1R/B/T/EC/BL/G	500 gms	400 gms	16

127 Mini Lever Grease Gun G14

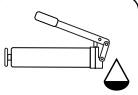

0.55GM / STROKE



6,000 PSI

When you need a tough little grease gun for hard to reach places, this is it!

Compact tool box size grease gun

Aluminium die cast head

Complete with 150 mm rigid steel extension & 4 jaw coupler

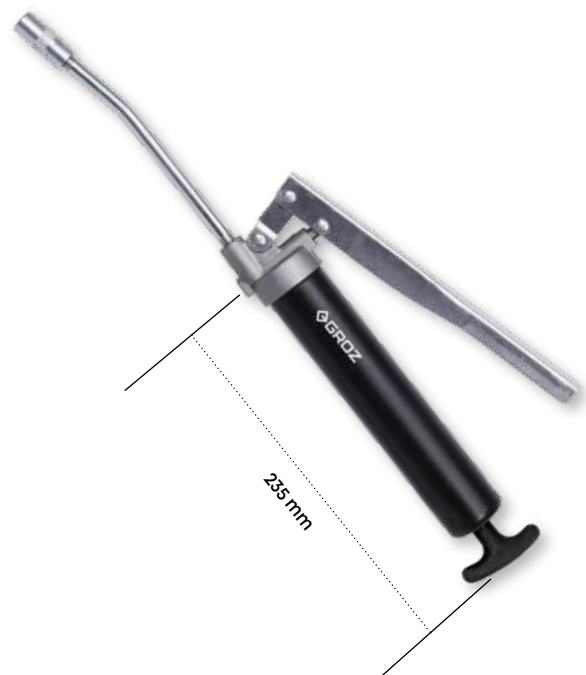

ORDERING INFORMATION

CAT NR.	CARTRIDGE CAPACITY	BOX QTY.
G14R/B	85 gms	16



128

Pistol Grip Grease Gun

G5



Most popular one hand grease gun designed for use in confined spaces

1.2 mm thick steel barrel with follower spring

Aluminium die cast CNC machined head with steel block nut

Handle designed to prevent finger pinching

Complete with 100 mm rigid steel extension & 4 jaw coupler



ORDERING INFORMATION

CAT NR.	CAPACITY		BOX QTY.
	BULK	CARTRIDGE	
G5R/B	500 gms	400 gms	16

129

Mini Pistol Grease Gun - Deluxe

G16



One hand pistol grip grease gun with convenient pull type operating mechanism

Aluminum cast head with front & top discharge ports

Durable powder coated finish

Ideal for greasing in tight spaces such as CNC machines

Complete with 100 mm rigid steel extension & 4 jaw coupler

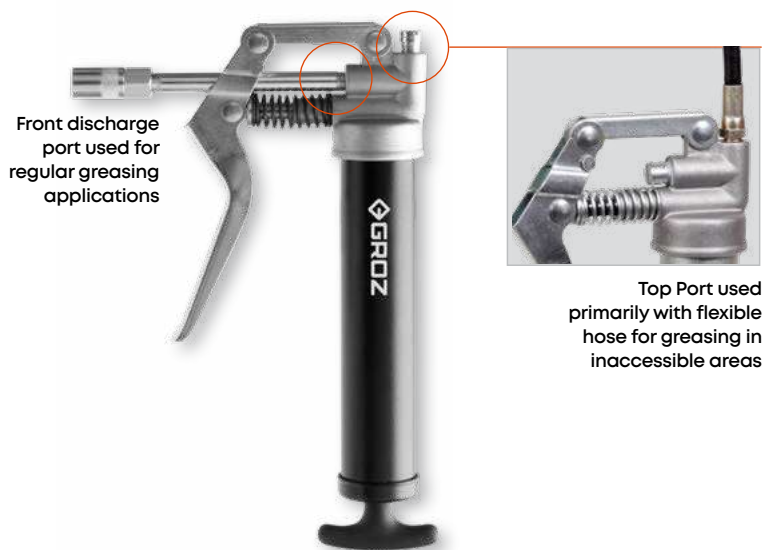

ORDERING INFORMATION

CAT NR.	CAPACITY		BOX QTY.
	BULK	CARTRIDGE	
G-16/B	120 gms	85 gms	30

130 Mini Grease Gun Push Type

G3P

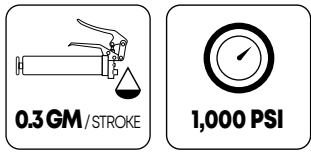

Push type grease guns to lubricate hammer mechanism in wrenches with flush type grease fittings, air tools, lawn mowers, ATV, RV's etc.

Small tip opening ensures precise & correct lubricants

Die cast aluminium head with 2 threaded pockets to hold spare needle nozzles

Compatible with most flush type fittings



ORDERING INFORMATION

CAT NR.	CARTRIDGE CAPACITY	BOX QTY.
G3P	85 gms	36

131 Air Operated Grease Gun

AGG

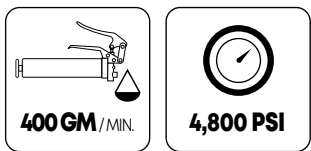

High power, continuous flow air operated grease gun

Continuous discharge of grease with the trigger pressed

For use in factory maintenance, agricultural applications, fleet service or for use on trucks connected to vehicle air brake compressors

Complete with 150 mm rigid steel extension & 4 jaw coupler



ORDERING INFORMATION

CAT NR.	CAPACITY		BOX QTY.
	BULK	CARTRIDGE	
AGG/1R/B	500 gms	400 gms	4

SPECIFICATIONS

AIR OPERATING RANGE	40-120 PSI (3-8 BAR)
PRESSURE RATIO	40:1
AIR COMPRESSOR VOLUME	1 CFM / 0.026 CBM @ 6 BAR
AIR INLET THREADING	1/4" (F)



132

Battery Powered Grease Gun

CE UK CA

NEW!



UNMATCHED FEATURES

Lithium-ion

4,000
mAh battery

Dispenses

Upto
26
Cartridges
in free flow

Upto
300
gm/min

Max. Pressure

10,000
PSI

Charge Time

2.5
Hours

BGG

The new revolutionary Battery Powered Grease Gun

Powerful 20V high torque Motor

2 Speed Design

Easy switch between high pressure & high volume setting to match application

a. High Pressure

Develops upto 10,000 PSI (690 BAR)
Delivers upto 85 gms / minute

b. High Volume

Develops upto 5,000 PSI (345 BAR)
Delivers upto 300 gms / minute

Unmatched Safety

Automatic cut-off as soon as pressure unit is reached prevents gear failure

Pre-set Grease Discharge

14 pre-set positions to control specific grease outflow prevents over lubrication



Rotate knob to set at pre-defined grease discharge

POSITION	GREASE DISPENSED	
	(OZ.)	(GMS)
1	0.02	0.61
2	0.04	1.30
3	0.05	1.70
4	0.09	2.8
5	0.10	3
6	0.13	3.9
7	0.15	4.4
8	0.18	5.2
9	0.21	6
10	0.22	6.4
15	0.28	8.2
20	0.45	13
25	0.57	16.3
50	1.1	32

ORDERING INFORMATION

CAT. NR	DETAILS
BGG/20-4/LI/EU	Grease gun, hose with coupler, 1 pc Li-ion battery & battery charger EU plug
BGG/20/DMM	Grease gun, hose with coupler & battery adaptor compatible with Dewalt, Milwaukee & Metabo batteries
BGG/20/PHMB	Grease gun, hose with coupler & battery adaptor compatible with Panasonic, Hikoki, Makita & Bosch batteries
SPARES	
RB/BGG/20-4LI	Rechargeable Battery 4000mAh
BC/BGG/20-4LI/EU	CE & ETL certified battery charger. 220V/50Hz, 20V EU Plug
HOS/BG/40/N	40" (1000mm) replacement hose
ADP/RB/DMM/BGG	Battery adaptor compatible with Dewalt, Milwaukee & Metabo batteries
ADP/RB/PHMB/BGG	Battery adaptor compatible with Panasonic, Hikoki, Makita & Bosch batteries

FILLING OPTIONS

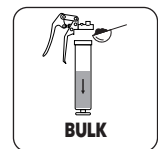
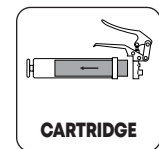

ONE GUN, ANY BATTERY

The all new GROZ Battery Adaptor allows the grease gun to be used with multi-brand batteries



ADP/RB/DMM/BGG

Compatible with



18V BATTERY



14.4V & 18V
SERIES BATTERY



20V BATTERY



ADP/RB/PHMB/BGG

Compatible with



18-20V BATTERY



18-20V BATTERY



18-20V BATTERY



18-20V BATTERY

133

USB Rechargeable Battery Grease Gun

RGG

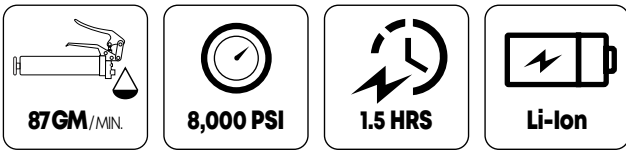

World's first battery grease gun with inbuilt battery

Pumps 3 times higher than manual grease guns

Robust aluminium die cast head fitted with air release valve

Barrel in premium powder coated finish

Inbuilt, lightweight & compact battery :

- **2000 mAh Lithium-Ion battery powers the 12V motor**
Empties upto 7 (14oz./400gms) grease cartridges on full charge

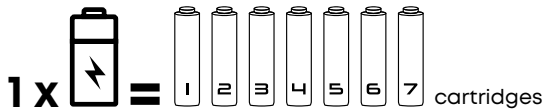

- **Fast charging** of battery via Type-C charging cable

Designed for everyday maintenance jobs in garages, workshops & other applications

Complete with

- Grease Gun Assembly
- 30" (750 mm) High Pressure Hose with Spring Guard
- 3 Jaw Hydraulic Coupler



HOS/BG/30/N
Hose



HC/18/3/N
3 Jaw Coupler



Battery Inside
Built-in rechargeable
2000 mAh Lithium-Ion battery

ORDERING INFORMATION

CAT NR.	DESCRIPTION	CAPACITY	BOX QTY.
		CARTRIDGE	
RGG/12L	Rechargeable grease gun	400 gms	1
SPARE PARTS & ACCESSORIES			
HC/18/3/N	3 Jaw Hydraulic Coupler		1

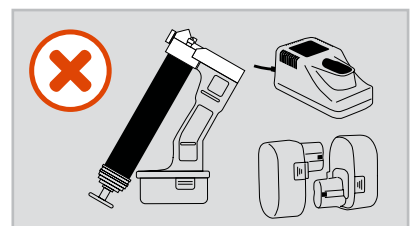

No more bulky grease guns
and separate batteries

134 Grease Gun Holder Magnetic

GGH-M

NEW!

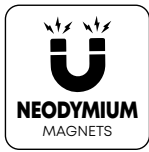

Grease gun holder with powerful magnets on both sides

The back plate is equipped with powerful neodymium magnets that make it convenient to affix the holder to any metallic surface. Two magnets on the front panel hold the grease gun securely

The holder is designed for hand operated grease guns with barrel diameter upto 2-1/4" (57.15 mm)

Perfect for use in workshops, garages, manufacturing units, maintenance areas and inside trucks and vans



MOUNTING OPTIONS



Magnet on back
Simply attach to any metallic surface



Wall Mounted
Holes to screw on the wall

ORDERING INFORMATION

CAT NR.	BOX QTY.
GGH/M/01	10

WARNING

Keep away from all electronic gadgets

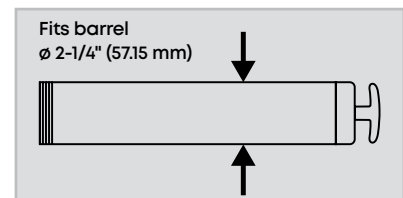

135

Quick Lock Grease Coupler

HC-21



8,000 PSI

Quick disconnect coupler for convenient, hands free operation!

Disengaging a coupler from a grease fitting, under pressurised conditions is very difficult & often leads to broken fittings or damage to the coupler jaws

Grease coupler takes away this worry with it's unique 6 point contact design. It is designed for quick & convenient dis-engagement of coupler from grease / zerk fittings under pressure

The Engagement system moves inside the steel wall when the thumb lever is actuated. This provides additional back support to the mechanism in high pressure applications.

1-1/2 times stronger coupler body is heat treated to withstand high pressures without deformation.

Case hardened rollers hold the coupler in position when subjected to high pressure applications

Universal Design

The design permits usage on all profiles of Grease Fittings – SAE, DIN, BS etc

Robust Construction

Threaded two piece construction for easy repairs

Repair kit available



SCAN TO WATCH

ORDERING INFORMATION

CAT NR.	BOX QTY.
HC/21/BSP	50

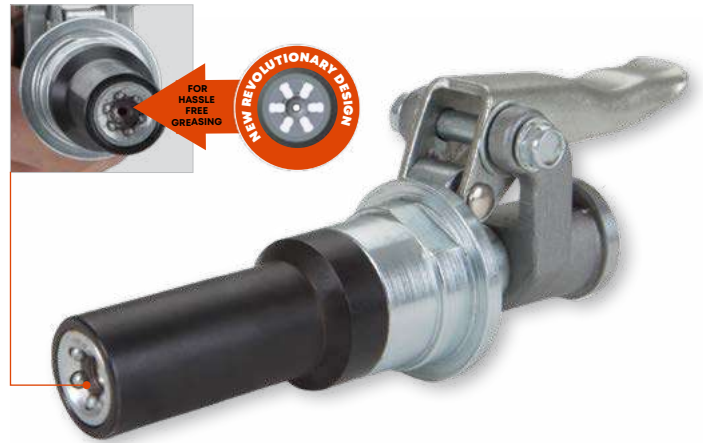

Convenient Engagement

Press thumb lever & slide the coupler onto the fitting. 6 hardened cylindrical pins hold the grease/zerk fitting tight



Easy Release

Press the thumb lever to disconnect coupler from the zerk fitting



136

**Grease Coupler
Quick - Disconnect**

HC-22



Unique Patented Grease Coupler

Designed for quick & convenient disengagement of the coupler from grease fittings under high pressure

Jaws are designed to fit all types of head profiles & work with both SAE & metric fittings

Coupler jaws are built from heat treated spring steel for increased wear resistance

Jaws move inside the steel wall when the lever is actuated. This provides additional back support to the jaws in high pressure greasing

3 Jaw construction helps in better alignment.

Ergonomic palm press lever action to engage & dis-engage coupler

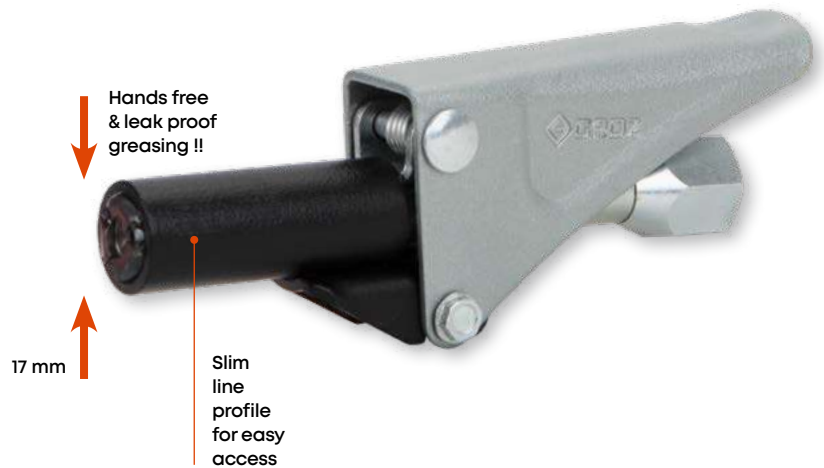

Convenient Engagement

Press lever and slide the coupler jaws on the grease fitting. Coupler engages completely & remains firm thus allowing hands free operation.



Easy Release

Simply press the lever to disconnect coupler from grease fitting.

ORDERING INFORMATION

CAT NR.	THREAD	BOX QTY.
HC/22/3/N	1/8" NPT	100



137 Hydraulic Couplers Standard HC-11

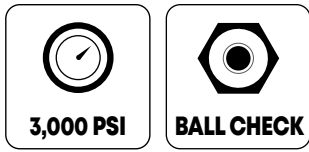

Most popular couplers for use with grease guns for general maintenance

Narrow coupler design for use on fittings with limited access

Milled slot for easy tightening

Fully hardened spring steel jaws

Recommended for use with hand operated grease guns

For use with hand operated grease guns



ORDERING INFORMATION

CAT NR.	THREADS	JAWS	BOX QTY.
HC/11/4/B	1/8" BSPT	4	500
HC/11/4/BSP	1/8" BSP	4	100

CAT NR.	DESCRIPTION	THREADS	JAWS	BOX QTY.
HC/11/4/B/ST2	Set - Pack of 2	1/8" BSPT	4	12
HC/11/4/B/ST5	Set - Pack of 5	1/8" BSPT	4	12
HC/11/4/B/ST10	Set - Pack of 10	1/8" BSPT	4	12
HC/11/4/B/ST54	Set - Pack of 54	1/8" BSPT	4	12

138 Hydraulic Couplers Professional HC-14

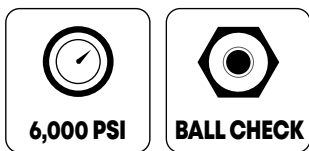

Best selling coupler for professional use

Hardened coupler body withstands high pressure without deformation

Fully hardened spring steel jaws

Hexagonal nut for easy tightening

Recommended for use with hand operated grease guns

For use with hand operated grease guns



ORDERING INFORMATION

CAT NR.	THREADS	JAWS	BOX QTY.
HC/14/3/B	1/8" BSPT	3	100
HC/14/4/B	1/8" BSPT	4	100

139 Hydraulic Couplers Heavy Duty HC-12

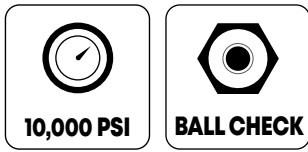

Heavy duty couplers recommended for use with air operated grease guns

Hardened coupler body with double wall thickness withstands high pressure without deformation

Fully hardened spring steel jaws

Hexagonal nut for easy tightening

For use with hand & air operated grease guns



ORDERING INFORMATION

CAT NR.	THREADS	JAWS	BOX QTY.
HC/12/3/B	1/8" BSPT	3	100
HC/12/4/B	1/8" BSPT	4	100

140 Button Head Couplers PCN-1 PCN-3

PCN-2



Push-on grease couplers for use with button head grease fittings, found mainly on heavy machinery, agricultural & contractor's equipment etc.

Zinc die cast construction with metal seal imparts increased resistance to wear

For use with hand operated grease guns

Threaded 1/8" BSPT (F)



PCN-1
Fixed Push-On
5/8" (16 mm)
Button Head Fittings



PCN-3
Medium Duty
5/8" (16 mm)
Button Head Fittings



PCN-2
Heavy Duty
7/8" (22 mm)
Giant Button Head Fittings

ORDERING INFORMATION

CAT NR.	PRESSURE RATING		BOX QTY.
	(PSI)	(BAR)	
PCN/1/B	3000	207	10
PCN/3/B	4000	275	10
PCN/2/B	4000	275	10



141

Grease Gun Hoses

GHC



Grease hoses facilitate greasing of fittings in areas with limited access

Thermoplastic construction, fully flexible with outer diameter (O.D.) 8.5 mm

Zinc plated steel end connections with hydraulic crimping

For use with hand operated grease guns

Threaded 1/8" BSPT (M) on both ends



ORDERING INFORMATION

CAT NR.	LENGTH (END TO END)		BOX QTY.
	(MM)	(INCH)	
GHC-12/B	300	12	30
GHC-18/B	450	18	20
GHC-20/B	500	20	10

SPECIFICATIONS

WORKING PRESSURE	UPTO 3,500 PSI	UPTO 240 BAR
BURST PRESSURE	MIN. 11,600 PSI	MIN. 800 BAR

142

Grease Gun Steel Extensions

GBP

GSP



Steel construction with bright zinc plated finish

High strength rolled threads 1/8" BSPT(M) on both ends

For use with hand grease guns only

Available in straight & bent types



ORDERING INFORMATION

CAT NR.	LENGTH (END TO END)		TYPE	BOX QTY.
	(MM)	(INCH)		
GSP/4/B	100	4	Straight	100
GBP/6/B	150	6	Bent	100

143 Grease Cartridge

CTG

NLGI grade 2

Non messy, totally clean offering highest convenience in usage

Useful for all automotive, industrial, construction & agricultural applications

Recommended for use with GROZ grease guns

Cartridge capacity : 400 gms.

NEW!



ORDERING INFORMATION

CAT NR.	COLOR	THICKENER	WORKING TEMPERATURE RANGE		BOX QTY.
			°C	°F	
14 OZ. (400 GM)					
GRS/14C/CC/2G	Red	Calcium Complex	-20 – 120	-4 – 250	10
GRS/14C/CS/2G	Blue	Calcium Sulfonate Complex	-15 – 180	5 – 356	10
GRS/14C/PU/2G	Green	Polyurea	-30 – 120	22 – 250	10
3 OZ. (85 GM)					
GRS/3C/CC/2G	Red	Calcium Complex	-20 – 120	-4 – 250	10
GRS/3C/CS/2G	Blue	Calcium Sulfonate Complex	-15 – 180	5 – 356	10
GRS/3C/PU/2G	Green	Polyurea	-30 – 120	22 – 250	10

CAT NR.	DESCRIPTION	BOX QTY.
SETS OF 3 PCS FOR 3 OZ. (85 GM) CARTRIDGES*		
GRS/3C/CC/2G/ST3	3pc x Multi Purpose EP Grease (Red)	10
GRS/3C/CS/2G/ST3	3pc x Marine EP Grease (Blue)	10
GRS/3C/PU/2G/ST3	3pc x Heavy Duty EP Grease (Green)	10

144 Ezee Lube Kit

GAK

The Ezee-Lube kit comprises of a range of quick connect lube accessories.

Useful for even the most difficult greasing jobs

The constituents convert any grease gun fitted with jaw type coupler into special application greasing.

KIT CONSTITUENTS

1. Professional Recessed Lube Adaptor
2. Grease Injector Needle
3. Professional 90° Angled Lube Adaptor
4. Narrow Needle Nose Adaptor
5. Seal off Quick Dispenser
6. Right Angled Quick Coupler
7. Quick Connect Hose



ORDERING INFORMATION

CAT NR.	BOX QTY.
GAK/7	5





Manufactured to the most stringent quality standards – TS 16949 approved manufacturing

Head profile & dimensions are accurately controlled & conform to DIN 71412

Heat treated greasing ends

Zinc plating exceeds ASTM B117

Fittings have heat treated springs for increased life

Available ready from stock in a large selection of popular types & sizes, with many more variations custom manufactured



Grease Fitting – Straight



Grease Fitting Angled - 45°



Grease Fitting Angled - 90°

ORDERING INFORMATION

CAT NR.	TYPE	HEX SIZE	OVERALL LENGTH	BOX QTY.
6.0 × 1.0 MM TAPER THREADS				
GFT/6/1	Straight	7 mm	16 mm	100
GFT/6/1/45	45°	9 mm	21 mm	50
GFT/6/1/90	90°	9 mm	18 mm	50
8.0 × 1.0 MM TAPER THREADS				
GFT/8/1	Straight	9 mm	16 mm	100
GFT/8/1/45	45°	9 mm	21 mm	50
GFT/8/1/90	90°	9 mm	18 mm	50
10.0 × 1.0 MM TAPER THREADS				
GFT/10/1	Straight	11 mm	16 mm	100
GFT/10/1/45	45°	11 mm	21 mm	50
GFT/10/1/90	90°	11 mm	18 mm	50
10.0 MM × 1.5 MM TAPER THREADS				
GFT/10/1.5	Straight	11 mm	18 mm max.	100
GFT/10/1.5/45	45°	11 mm	21 mm max.	50
GFT/10/1.5/90	90°	11 mm	18 mm max.	50
1/8" × 28 BSPT - TAPER THREADS				
GFT/R/1-8/28	Straight	11 mm	16 mm	100
GFT/R/1-8/28L	Straight	11 mm	20 mm	50
GFT/R/1-8/28/45	45°	11 mm	21 mm	50
GFT/R/1-8/28/45L	45°	11 mm	26.3 mm	50
GFT/R/1-8/28/90	90°	11 mm	18 mm	50
GFT/R/1-8/28/90L	90°	11 mm	21.4 mm	50
1/4" × 19 BSPT - TAPER THREADS				
GFT/R/1-4/19	Straight	9/16"	17.5 mm	50
GFT/R/1-4/19L	Straight	15.24 mm	23.5 mm	25
GFT/R/1-4/19/45	45°	9/16"	22.5 mm	50
GFT/R/1-4/19/90	90°	9/16"	22 mm	50

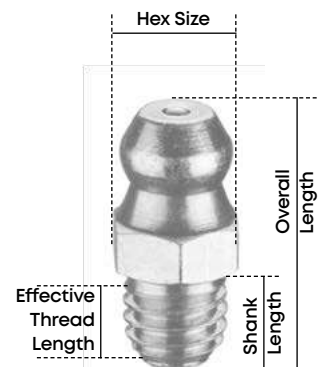

146

Grease Feeders

GFD

Grease Feeders are used to provide single point controlled lubrication for all types of bearing housings

Eliminates difficulties arising due to over or under greasing

Working on a spring compression mechanism, the design regulates grease discharge in proportion to changing spring pressure, thus maintaining constant discharge pressure of 1- 2 PSI

Die cast aluminium bodies with polycarbonate dome assembled with medium springs. Heavy & light spring come as spares in the same pack and can be easily interchanged depending upon application

1/8" (M) steel adaptor at the tail end fits directly onto bearing housings

Can be mounted in any position for easy visual inspection of grease levels

Reusable: Can be refilled easily with immediate activation

Remote Refill kit also available that permits remote filling of grease from distances up to 3 meters (10')

RECOMMENDED USE

For use with NLGI 0 to 4 non separating grease on any equipment that

- has anti friction, oscillating or roller bearings
- has shielded bearings with seals
- has bronze, olite or open bearings
- requires bearing flushing action

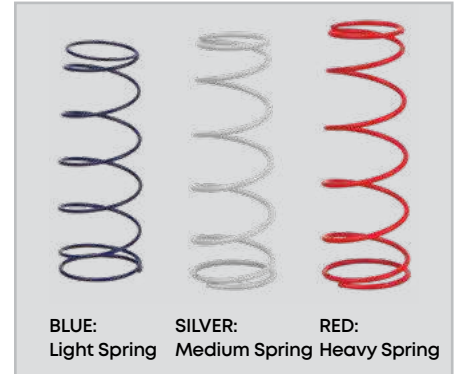

SPRING SELECTION GUIDE

OPERATING TEMPERATURE		NLGI GREASE TYPE				
FROM	TO	NO. 0	NO. 1	NO. 2	NO. 3	NO. 4
-23°C	4°C	Blue	Silver	Red		
4°C	43°C	Blue	Silver	Silver	Red	
43°C	93°C		Blue	Silver	Silver	Red
93°C	121°C			Blue	Silver	Red

SIZE SELECTION GUIDE

BEARING SHAFT DIA.	Upto 1-1/2" (38 mm)				1-1/2" (38 mm) & over			
	Intermittent		Continuous		Intermittent		Continuous	
OPERATING CONDITION	Open	Sealed	Open	Sealed	Open	Sealed	Open	Sealed
CLASS OF BEARING	Open	Sealed	Open	Sealed	Open	Sealed	Open	Sealed
UNDER 1000 RPM	1 oz.	1 oz.	1 oz.	1 oz.	2 oz.	2 oz.	2 oz.	2 oz.
1000 TO 2500 RPM	1 oz.	1 oz.	1 oz.	1 oz.	2 oz.	2 oz.	6 oz.	6 oz.
OVER 2500 RPM	2 oz.	1 oz.	2 oz.	2 oz.	6 oz.	6 oz.	6 oz.	6 oz.

ORDERING INFORMATION

CAT NR.	BOWL CAPACITY		OVERALL DIA.		OVERALL HEIGHT		BOX QTY.
	(OZ.)	(GMS)	(INCH)	(MM)	(INCH)	(MM)	
GFD/PA/1/B	1	28	1-3/4	40	3-5/8	92	1
GFD/PA/2/B	2	56	2-3/8	60	4-5/8	117	1
GFD/PA/6/B	6	170	3	75	6	150	1
REMOTE GREASE REFILL KIT							
GFD/RK/1	3m (10') Grease hose with all fittings						1



Now experience effortless greasing with our upgraded VGP Pump that comes with the innovative Quick Lock Grease Coupler!

Easy & quick lock-on mechanism, easy disengagement even under high pressure and hands-free operation, makes bulk greasing effortless, efficient and hassle free.

For use with agricultural equipment, commercial vehicles, excavators & other earth moving equipment

Variable Handle Setting

Can be set for high volume or high pressure grease discharge. Pump delivers upto 9gms of grease on high volume setting. Fully CNC machined to close tolerances the pump develops upto 4,000 PSI (275 BAR) on high pressure setting

Includes follower plate

WETTED COMPONENTS

Steel, Aluminium, Brass & Nitrile Rubber

RECOMMENDED USE

NLGI 1, 2 & 3 greases



High Pressure Setting

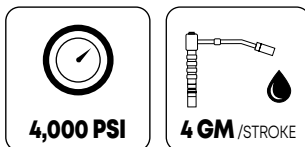

Medium Pressure Setting

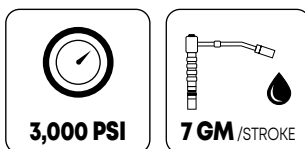

High Volume Setting

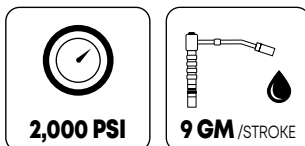

VARIABLE HANDLE SETTING

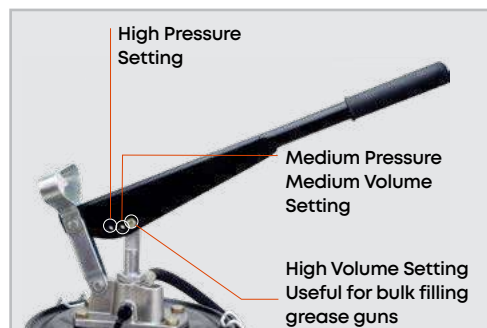

ORDERING INFORMATION

CAT NR.	DESCRIPTION	BOX QTY.
VGP/6A/Q	Without Wheels	1
VGP/6/Q	With Wheels	1



SCAN TO WATCH



148

Grease Pump Heavy Duty

VGP-HD

USTAAD the only 6,000 PSI hand grease pump built for the toughest environments!

Heavy-Duty Grease pump for quick and effortless greasing in applications requiring voluminous grease at high pressures

Designed for everyday lubrication of excavators and other earth moving equipment with multiple greasing points

Variable Handle Setting

Pump can be set for high volume or high pressure dispensing

Unbreakable Footrest

Designed to take a heavy beating the sturdy footrest is in-built in the pump base making it virtually unbreakable

Fully CNC machined pump internals for quick and easy priming

Available in 6 kg and 10 kg bucket capacity

WETTED COMPONENTS

Steel, Aluminum, Brass & Nitrile Rubber

RECOMMENDED USE

For Grease up to and including NLGI 3

High Pressure Setting

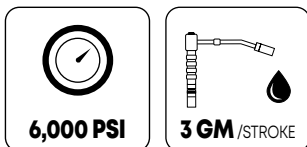

Medium Pressure Setting

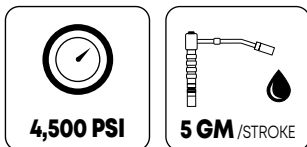

High Volume - Low Pressure Setting

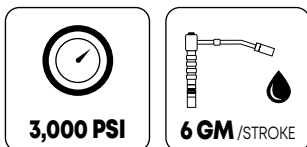

ORDERING INFORMATION

CAT NR.	CAPACITY (KG)	BOX QTY.
VGP/HD/6A	6	1
VGP/HD/10A	10	1



VARIANTS



VARIABLE HANDLE SETTING

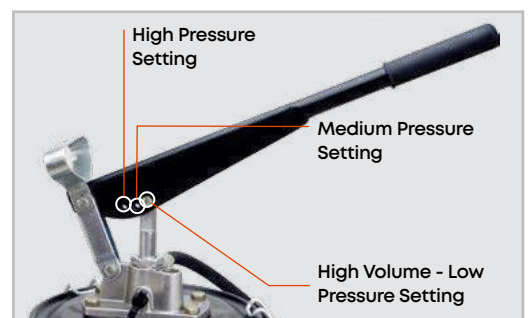

Volume grease pump designed for quick & effortless greasing in applications requiring large volume of lubrication everyday

For use with agricultural equipment, excavators & other earth moving equipment & in automotive applications

Variable Handle Setting

can be set for high volume or high pressure grease discharge. Pump delivers upto 9gms of grease on high volume setting. Fully CNC machined to close tolerances the pump develops upto 4,000 PSI (275 BAR) on high pressure setting

Includes follower plate

WETTED COMPONENTS

Steel, Aluminium, Brass & Nitrile Rubber

RECOMMENDED USE

NLGI 1, 2 & 3 greases

High Pressure Setting

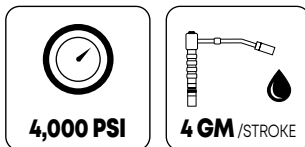

Medium Pressure - Medium Volume Setting

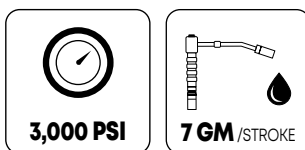

High Volume Setting

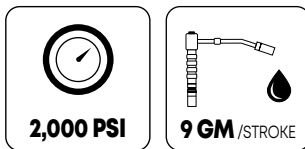

ORDERING INFORMATION

CAT NR.	CAT NR.	CAPACITY	BOX QTY.
		(KG)	
WITHOUT WHEELS	WITH WHEELS		
VGP/3A/RF	---	3	1
VGP/6A	VGP/6	6	1
VGP/10A	VGP/10	10	1
---	VGP/15	15	1
---	VGP/20	20	1



VARIABLE HANDLE SETTING

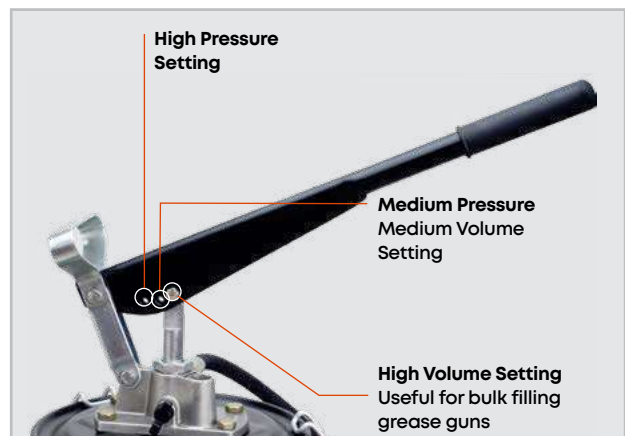

VGP

150

Scoop & Swipe Set



VGP/3A/RF
(without wheels)



VGP/6
(with wheels)



VGP/6A
(without wheels)



VGP/10
(with wheels)



VGP/15
(with wheels)



VGP/20
(with wheels)



Now you can avoid the mess while working with bulk grease with hands

Use the GROZ Grease Scooper to avoid grease contamination and spillage in 3 simple steps



STEP 1
Use the Scooper to draw sizable amount of grease from the bucket.



STEP 2
Use the swipe to clean the Scooper from inside.



STEP 3
Use the swipe to clean the Scooper from outside.

ORDERING INFORMATION

CAT NR.	BOX QTY.
GSW/1/ST	10



151

Grease Pump Foot Operated

FOP



NEVER BEATEN ON PERFORMANCE!

High pressure portable grease pump for quick effortless greasing in everyday lubrication such as greasing of excavators & other earth moving equipment, agricultural equipment, automotive etc.

Hands free operation

Pump operates using the foot lever, which greatly reduces effort & allows high pressure greasing with highest comfort. Can be operated by hand when under low machinery

Fill It – Forget It

Holds upto 10 kg grease, which is 25% more than similar pumps in the market

Economical

Pump is operated by a single person & uses low cost bulk grease

Designed To Perfection

Designed with all moving parts submerged in the same grease which needs to be pumped, thereby staying lubricated at all times

Moving parts create wave action in grease, auto removing air pockets & eliminating the use of a follower plate

RECOMMENDED USE

NLGI 1 & 2 greases

Lift handle

Steel drum cover

Steel bucket
10 kg
capacity

Nozzle
holder

Pistol handle
fitted with
steel grease
extension &
professional
coupler

Includes
2m x 1/4" ID high
pressure rubber
hose

Foot lever

Rubber pads



ORDERING INFORMATION

CAT NR.	CAPACITY	BOX QTY.
	(KG)	
FOP/10A	10	1



SCAN TO
WATCH



152 Portable Greasing System

GS-5



Fully portable & single person operated manual greasing system

Designed for volume greasing in workshop environments, site applications, on a pick-up truck, tractor, earth moving equipment etc

Convenient Foot Charged Pump

Pump is operated by foot press of the spring loaded system. The hose gets charged with grease, which can then be dispensed through the super gun fitted at the end of the hose. A single charge provides upto 30 shots of grease

Quick & Convenient Adjustment

Aluminium die cast super gun has high pressure & high volume settings, actuated through a simple switch

SETTING	PRESSURE	DELIVERS	APPLICATION
High Pressure	10,000 PSI (690 BAR)	UPTO 0.45 GM/STROKE	Cold weather, blocked fittings
High Volume	5,000 PSI (345 BAR)	UPTO 1.25 GM/STROKE	Volume greasing

Pump assembly is fully sealed to prevent contamination

Complete with drum cover, rubber lined follower plate, premium 1/2" ID high pressure hose, super gun fitted with steel extension, coupler and 5 kg plastic grease bucket

WETTED COMPONENTS

Aluminium, Steel, Brass, Polyurethane & Nitrile Rubber

RECOMMENDED USE

NLGI 1 & 2 greases

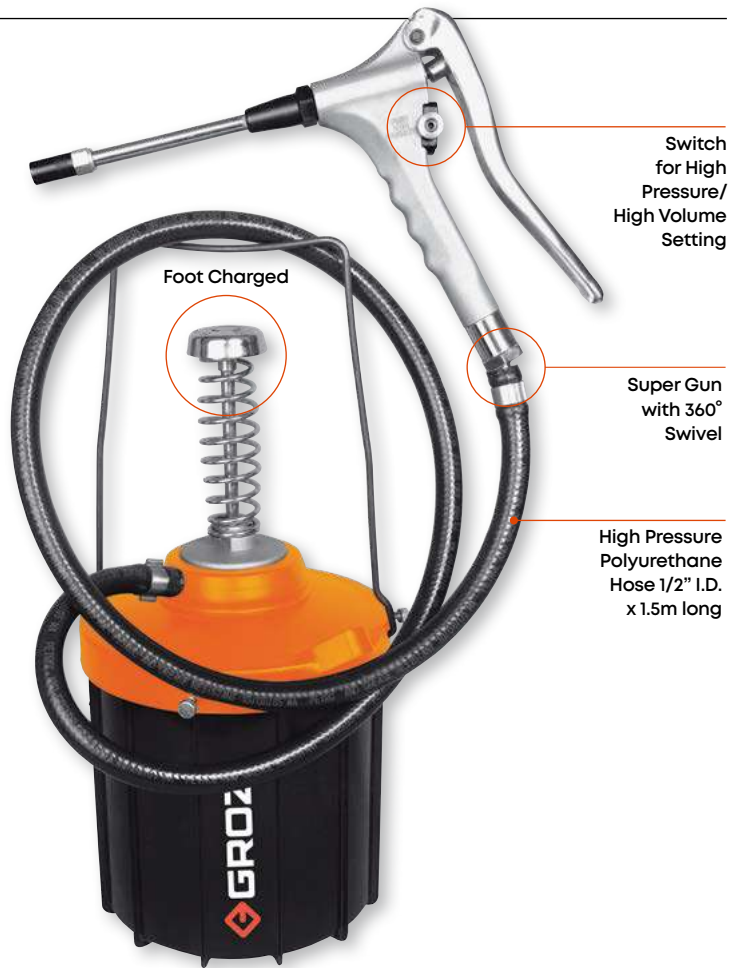

Common sight on construction equipment requiring high volume routine greasing

ORDERING INFORMATION

CAT NR.	BUCKET CAPACITY	PUMP LENGTH BELOW DRUM COVER			DRUM COVER DIAMETER		FOLLOWER PLATE DIMENSIONS				HOSE LENGTH	BOX QTY.
		(KG)	(MM)	(INCH)	(MM)	(INCH)	O.D. STEEL END		O.D. PLATE			
							(MM)	(INCH)	(MM)	(INCH)		
GS/5	5	197	7-3/4	216	8-1/2	171	6-3/4	206	8-1/8	1.5	1	



153

Air Operated Grease Ratio Pumps 50:1



Pump dispenses grease at pressures up to 50 times the air inlet pressure

Designed to work in tough conditions; these are ideal for use in industry, workshop, farm, construction or as part of the Mobile Grease System

All metal construction, fully CNC machined with hardened wear resistant moving parts

Reciprocating piston operated 63 mm dia. air motor

Strainer at suction tube inlet removes dirt, debris etc from entering into the system

WETTED COMPONENTS

Steel, Brass, Aluminium, Polyurethane & Nitrile Rubber

RECOMMENDED USE

Light & self collapsing grease upto NLGI 2

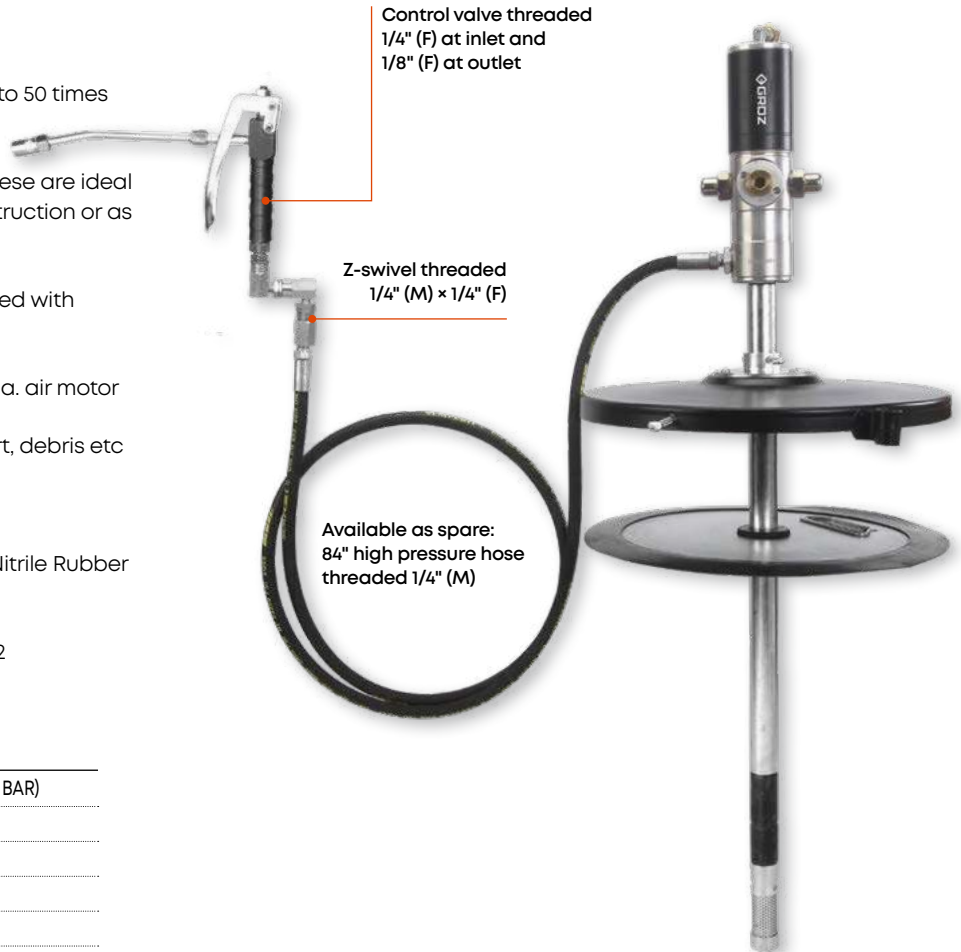

SPECIFICATIONS

WORKING PRESSURE	30-150 PSI (2-10 BAR)
MAXIMUM AIR PRESSURE	150 PSI (10 BAR)
AIR INLET CONNECTION	1/4" BSP (F)
PUMP OUTLET CONNECTION	1/4" BSP (F)
AIR CONSUMPTION	230 LPM
NOISE LEVEL	81 db

ORDERING INFORMATION

CAT NR.	DRUM SIZE	SUCTION TUBE LENGTH	DRUM COVER DIA.	FOLLOWER PLATE DIMENSIONS			BOX QTY.
				O.D. STEEL END	O.D. PLATE	I.D. GROMMET	
GREASE PUMP KIT							
GP1/ST/501/BSP	20-30 KG	440 MM	305 MM	241 mm	288 mm	29.5 mm	1
GP2/ST/501/BSP	50-60 KG	730 MM	381 MM	322 mm	380 mm	29.5 mm	1
GP3/ST4/501/BSP	180 KG	950 MM	612 MM	550 mm	602 mm	29.5 mm	1
PUMP ONLY							
GP3/501/BSP	180 KG	950 MM	-	-	-	-	1
GP3/501/N	180 KG	950 MM	-	-	-	-	1

GP
BGRP

VARIANTS

GREASE PUMP KITS - WITH FOLLOWER PLATE, DRUM COVER, 84" HIGH PRESSURE HOSE & GREASE CONTROL VALVE			PUMP ONLY
			
GP1 For 20-30 kg pails	GP2 For 50-60 kg pails	GP3 For 180 kg drums	GP3/501/BSP For 180 kg drums
PORTABLE AIR OPERATED GREASE PUMP ASSEMBLY WITH BUCKET			
			
BGRP/15 Capacity: 15 Kg	BGRP/30 Capacity: 30 Kg	BGRP/50 Capacity: 50 Kg	

ORDERING INFORMATION

CAT NR.	BUCKET CAPACITY	BOX QTY.
	(KG)	
PORTABLE AIR OPERATED GREASE PUMP ASSEMBLY WITH BUCKET		
* BGRP/15	15	1
* BGRP/30	30	1
* BGRP/50	50	1

* Best Seller

WARNING

Pump must be supplied with clean & dry compressed air via an FRL unit



Trolley mounted kits are ideal for use in workshops, garages, shop floors providing complete portability for everyday lubrication needs

TMK-GP1

KIT INCLUDES

A	50:1 Air Operated Grease Pump
B	Grease Control Valve Fitted with 360° Z swivel for trouble free dispensing
C	Connecting Hose 84" x 1/4" I.D. (2m x 6.5 mm I.D.) - SAE R2
D	Steel Drum Cover 12" (310 mm) Prevents impurities from contaminating grease and keeps pump in vertical position
E	Rubber Lined Follower Plate O.D. Steel End: 9-1/2" (241 mm) O.D. Plate: 11-11/32" (288 mm) I.D. Grommet: 1-3/16" (29.5 mm)
F	Drum Trolley - Heavy Duty Manufactured from 4 mm thick steel sheet in powder coated finish Front Wheels: 6" (150 mm) polyurethane with nylon rim Rear castors with toe lock
G	*Filter-Regulator Combination & Lubricator with Pressure Gauge (FRCLM) Port Size: 1/4" Type: Miniature Filter: 40 micron

*On selected models



WETTED COMPONENTS

Steel, Brass, Aluminium, Polyurethane & Nitrile
Rubber

RECOMMENDED USE

With light and self collapsing grease up to NLGI No. 2

ORDERING INFORMATION

CAT NR.	DESCRIPTION	THREADS	BOX QTY.
TMK/GP1/A/BSP	Pump kit with FRCLM unit	1/8" BSPT	1

SPECIFICATIONS

WORKING PRESSURE	30-150 PSI	2-10 BAR
MAX. AIR PRESSURE	150 PSI	10 BAR
MAX. OUTLET PRESSURE	7,500 PSI	500 BAR
AIR INLET CONNECTION	1/4" (F)	
PUMP OUTLET	1/4" (F)	
AIR CONSUMPTION	72 GPM	270 LPM
NOISE LEVEL	85 db	
GREASE OUTPUT (MAX.)	2.42 lbs./min.	1.1 kg/min.
FOR USE WITH	35 lbs. drums	20-30 kg drums

TMK-GP

CE

TMK-GP2**KIT INCLUDES**

A	50:1 Air Operated Grease Pump
B	Grease Control Valve Fitted with 360° Z swivel for trouble free dispensing
C	Connecting Hose 84" x 1/4" I.D. (2m x 6.5 mm I.D.) - SAE R2
D	Steel Drum Cover 15" (381 mm) Prevents impurities from contaminating grease and keeps pump in vertical position
E	Rubber Lined Follower Plate O.D. Steel End: 12-11/16" (322 mm) O.D. Plate: 15" (380 mm) I.D. Grommet: 1-3/16" (29.5 mm)
F	Drum Trolley - Heavy Duty Manufactured from 4 mm thick steel sheet in powder coated finish Front Wheels: 6" (150 mm) polyurethane with nylon rim Rear castors with toe lock
G	*Filter-Regulator Combination & Lubricator with Pressure Gauge (FRCLM) Port Size: 1/4" Type: Miniature Filter: 40 micron

*On selected models

**WETTED COMPONENTS**

Steel, Brass, Aluminium, Polyurethane & Nitrile Rubber

RECOMMENDED USE

With light and self collapsing grease up to NLGI No. 2

ORDERING INFORMATION

CAT NR.	DESCRIPTION	THREADS	BOX QTY.
TMK/GP2/A/BSP	Pump kit with FRCLM unit	1/8" BSPT	1

SPECIFICATIONS

WORKING PRESSURE	30-150 PSI	2-10 BAR
MAX. AIR PRESSURE	150 PSI	10 BAR
MAX. OUTLET PRESSURE	7,500 PSI	500 BAR
AIR INLET CONNECTION	1/4" (F)	
PUMP OUTLET	1/4" (F)	
AIR CONSUMPTION	72 GPM	270 LPM
NOISE LEVEL	85 db	
GREASE OUTPUT (MAX.)	2.42 lbs./min.	1.1 kg/min.
FOR USE WITH	120 lbs. drums	50-60 kg drums



Grease Pump Kits With HD Trolley (Continued)

TMK-GP3H



KIT INCLUDES

A	50:1 Air Operated Grease Pump
B	Grease Control Valve With Z swivel for trouble free dispensing
C	Grease Hose Reel - Heavy Duty Dual Arm Steel Reel Hose I.D.: 1/4" (6.35 mm) Maximum Pressure: 5800 PSI (400 BAR)
D	Steel Drum Cover 24-1/2" (612 mm) Prevents contamination of grease and keeps pump in vertical position
E	Rubber Lined Follower Plate O.D. Steel End: 21-5/8" (550 mm) O.D. Plate: 23-11/16" (602 mm) I.D. Grommet: 1-3/16" (29.5 mm)
F	Drum Trolley - Heavy Duty Manufactured from 4 mm thick steel sheet in powder coated finish Front Wheels: 6" (150 mm) polyurethane with nylon rim Rear castors with toe lock
G	Filter-Regulator Combination with Pressure Gauge (FRC) Port Size: 1/4" Type: Miniature Filter: 40 micron
H	Feeder Hose Connects pump outlet to the hose reel inlet Length: 1.5m (5')



WETTED COMPONENTS

Steel, Brass, Aluminium, Polyurethane & Nitrile
Rubber

RECOMMENDED USE

With light and self collapsing grease up to NLGI No. 2

ORDERING INFORMATION

CAT NR.	HOSE LENGTH		THREADS	BOX QTY.
	(M)	(FEET)		
TMK/GP3H/A/BSP	15	50	1/8" BSPT	1

SPECIFICATIONS

WORKING PRESSURE	30-150 PSI	2-10 BAR
MAX. AIR PRESSURE	150 PSI	10 BAR
MAX. OUTLET PRESSURE	7,500 PSI	500 BAR
AIR INLET CONNECTION	1/4" (F)	
PUMP OUTLET	1/4" (F)	
AIR CONSUMPTION	72 GPM	270 LPM
NOISE LEVEL	85 db	
GREASE OUTPUT (MAX.)	2.42 LBS./MIN.	1.1 KG/MIN.
FOR USE WITH	400 LBS. DRUMS	180 KG DRUMS

155

Grease Pump Kits With Drum Cart

TMK1-GP

Trolley Mounted kits are ideal for use in workshops, garages, shop floors, providing complete portability for everyday greasing jobs

Comes with robust drum cart

KIT INCLUDES

A	50:1 Air Operated Grease Pump
B	Grease Control Valve Fitted with 360° Z swivel for trouble free dispensing
C	Grease Hose Reel - Heavy Duty Dual Arm Steel Reel Hose I.D.: 1/4" (6.35 mm) Hose Length: 15 meter (50') Maximum Pressure: 5800 PSI (400 BAR)
D	Steel Drum Cover 24-1/2" (612 mm) Prevents impurities from contaminating grease and keeps pump in vertical position
E	Rubber Lined Follower Plate O.D. Steel End: 21-5/8" (550 mm) O.D. Plate: 23-11/16" (602 mm) I.D. Grommet: 1-3/16" (29.5 mm)
F	Drum Cart Manufactured from thick steel sheet in powder coated finish Front Wheels: 10" (250 mm) wide Rear castors with toe lock 5" nylon
G	Feeder Hose Connects pump outlet to the hose reel inlet Length: 1.5m (5')
H	Connecting Hose* 84" x 1/4" I.D. (2m x 6.5 mm I.D.) - SAE R2

TMK1/GP3H/B/BSP

TMK1/GP3/B/BSP

SPECIFICATIONS

WORKING PRESSURE	30-150 PSI (2-10 BAR)
AIR INLET CONNECTION	1/4" (F)
PUMP OUTLET	1/4" (F)
AIR CONSUMPTION	270 LPM
NOISE LEVEL	85 db
GREASE OUTPUT (MAX.)	1.1 KG/MIN.
FOR USE WITH	180 KG DRUMS

ORDERING INFORMATION

CAT NR.	DESCRIPTION	THREADS	BOX QTY.
TMK1/GP3H/B/BSP	With hose reel	1/8" BSPT	1
TMK1/GP3/B/BSP	Without hose reel	1/8" BSPT	1



156

**Grease Ratio Pump
High Volume**

GPH



Heavy Duty Industrial grade pneumatic pump

Particularly suitable for grease distribution in pipe works & installations where simultaneous grease supply is required on different dispensing points at high pressure or in large volume

Pump dispenses grease upto 50 times the air inlet pressure

All metal construction, fully CNC machined with hardened wear resistant moving parts

Reciprocating piston operated 3" (76 mm) dia. air motor

Stall free, ice free motor with tough durable housing, integrated muffler for quiet operation

No Service Required

With very few moving parts this rugged pump requires virtually no servicing. No special maintenance tools needed

Supplied complete with drum cover, rubber line follower plate, 3 m high pressure grease hose, Z swivel & professional grease control valve

WETTED COMPONENTS

Steel, Polyurethane, Nitrile Rubber, C.R.C. Sheet, Copper, PTFE

RECOMMENDED USE

NLGI 1, 2, 3 Grease

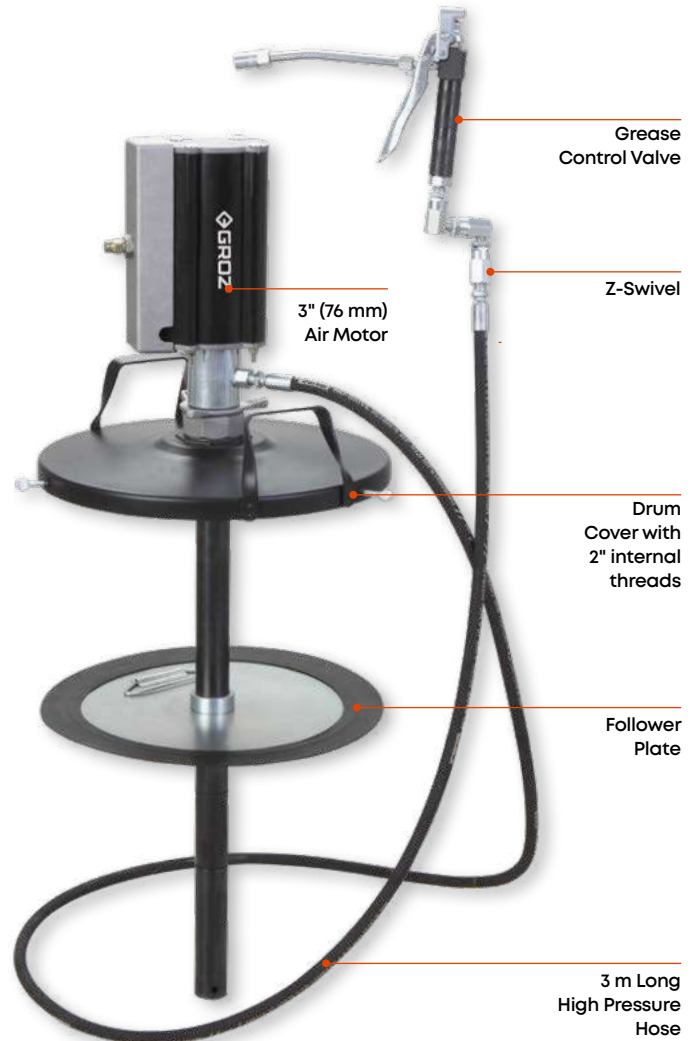

SPECIFICATIONS

WORKING PRESSURE	30-150 PSI (2-10 BAR)
AIR INLET CONNECTION	1/4" (F)
PUMP OUTLET CONNECTION	1/4" (F)
AIR CONSUMPTION	13 CFM
NOISE LEVE	85-90 dB

ORDERING INFORMATION

CAT NR.	FITS	DRUM COVER DIAMETER		FOLLOWER PLATE DIMENSIONS				BOX QTY.
				O.D. STEEL END		O.D. PLATE		
		(INCH)	(MM)	(INCH)	(MM)	(INCH)	(MM)	
GPH/1/ST/BSP	20-30 kg pails	12	310	9-1/2	241	11-11/32	288	1
GPH/2/ST/BSP	50-60 kg pails	15	381	12-11/16	322	15	380	1
GPH/3/ST/BSP	180 kg drums	24-1/2	612	21-5/8	550	23-11/16	602	1

157

Grease Control Valve Professional

APG-HD



Grease control valve for use with air operated grease pumps

Highly durable all steel construction, fully CNC machined

Dispenses grease at the same pressure as the pressure at pump outlet

Valve inlet fitted with 360° Z-swivel for convenient handling and to prevent hose from kinking

Complete with 6" steel extension & heavy duty coupler

ORDERING INFORMATION

CAT NR.	INLET THREADS	OUTLET THREADS	BOX QTY.
APG/HD/Z/1-4F/B	1/4" BSPT (F)	1/8" BSPT (F)	1



WARNING

Skin injection hazard.
Keep away from nozzle

CAUTION

The gun is continuous action.
Be careful not to over lubricate

158

Grease Control Valve Booster

APG



Grease control valve for use with air operated grease pumps

Built-in pressure boost mechanism allows grease pressure to be boosted from 6,000 PSI to 10,000 PSI

Pressure boost helps unclog blocked grease fittings & grease joints with high back pressure

Pressure boost is activated by a few repeated presses of the pistol handle

Highly durable all steel construction, fully CNC machined

Valve inlet fitted with 360° Z-swivel for convenient handling and to prevent hose from kinking

Complete with 6" steel extension & heavy duty coupler

ORDERING INFORMATION

CAT NR.	INLET THREADS	OUTLET THREADS	BOX QTY.
APG/Z/1-4F/B	1/4" BSPT (F)	1/8" BSPT (F)	1

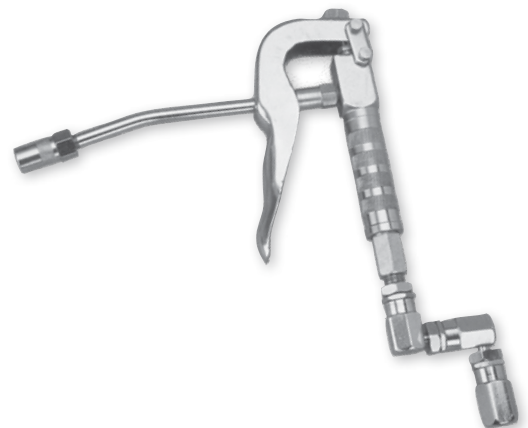

WARNING

Skin injection hazard.
Keep away from nozzle

CAUTION

The gun is continuous action.
Be careful not to over lubricate



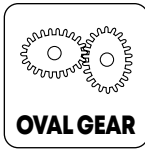

Premium quality grease control valve,
for use with air operated grease pumps

Built-in high accuracy digital grease
meter for dispensing
exact amount of grease

Ability to measure amount of grease
dispensed prevents both over & under
lubrication & is useful in saving bearing
failures

Provides continuous grease flow, with
trigger fully pressed

Steel construction, provides durability
& longevity. Meter uses oval gear
mechanism

Ergonomically designed pistol handle

Comes complete with 6" steel extension,
heavy duty coupler & 360° Z swivel

APG/HD/Z/1-4F/GM/B
SPECIFICATIONS

CONTROL VALVE TYPE	Continuous Flow
METER TYPE	Digital Oval Gear
GREASE FLOW	0.1 to 2.5 kg / minute
MAX. WORKING PRESSURE	7,500 PSI (517 BAR)
UNIT OF MEASUREMENT	kg /gms / lbs
ACCURACY	± 3%
RESETTABLE BATCH TOTAL	9,999 gms
CUMULATIVE TOTAL	99999.9 kg
BATTERY TYPE	1.5 V (Two numbers)

ORDERING INFORMATION

CAT NR.	DESCRIPTION	INLET THREAD	BOX QTY.
APG/HD/Z/1-4F/GM/B	Meter fitted to a grease control valve	1/4" BSPT (F)	1

WARNING

Skin injection hazard.
Keep away from nozzle

CAUTION

The gun is continuous action.
Be careful not to over lubricate.

160

Lever Action Barrel Pump

LBP-04



Oil pump designed & engineered for convenient use & long service life

Powder coated steel pump body with aluminum die cast pump head

Plated steel lever handle with rubber grip for convenience in usage

3/4" pump inlet

Complete with curved metal spout & telescopic suction tube for use on 50-210 litre drums.

WETTED COMPONENTS

Steel, Aluminium, NBR, Brass, PVC

RECOMMENDED USE

Oil Based Fluids, Heating Oils, Motor Oil, Heavy & Light Oils, Kerosene & Diesel

DO NOT USE WITH

Water Based Fluids, Solvents, Acids, Petrol etc.



ORDERING INFORMATION

CAT NR.	BOX QTY.
LBP/04/PT	10

161

Ezee Flow Pump

EZF



Versatile pump, engineered for trouble free use on 50 litre plastic drums with pull out / Rieke® spout or 2" external threads

Pump delivers on the upward stroke

Heavy duty steel suction tube, Nylon head incorporates nozzle holder & option to drain back over flown fluid into the container

Interchangeable bung adaptors

Standard bung adaptor is useful when using the pump on containers with external threadings. When using the pump on containers with plastic pull-out Rieke® spout, the other adaptor may be used

Complete with rigid steel discharge spout & 1.2 m discharge hose

WETTED COMPONENTS

Steel, Aluminium, Polyethylene, Nylon, High Nitrile Rubber, PVC & Acetal

RECOMMENDED USE

Engine Oils, Gear Oils, Diesel and Light Fuel Oils

DO NOT USE WITH

Water based & other corrosive media

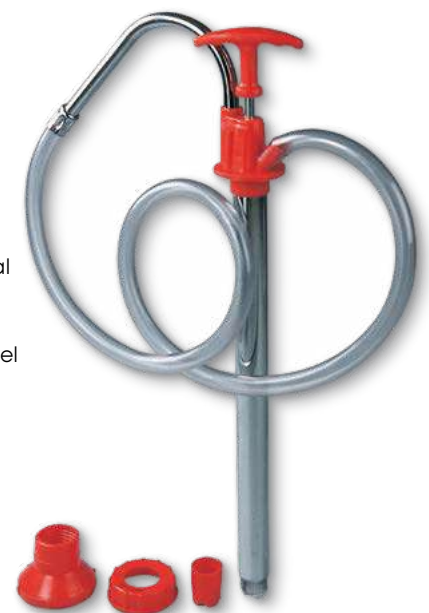

ORDERING INFORMATION

CAT NR.	NO. OF ADAPTORS	BOX QTY.
EZF/8	2	10

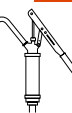

162 Rotary Barrel Pump V25



Most popularly used pump for general purpose lubrication on farms, automotive, workshops & construction sites

Dual Directional

Empty as well as refill containers just by the reverse turn of the handle

Rugged cast iron construction with machined vanes for better draw & smoother delivery

1" pump inlet

Complete with 3 pc rigid suction tube for use on 50-210 litre drums

WETTED COMPONENTS

Steel, Cast Iron, NBR

RECOMMENDED USE

Heating Oils, Motor Oils, Lubricating Oils etc.

DO NOT USE WITH

Water based Media, Acids, Petrol etc.



Dual directional operation

Pumps-in & pumps-out fluids by a few reverse turns of the handle

ORDERING INFORMATION

CAT NR.	BOX QTY.
V25/3R/SPL/F	4

163 Rotary Barrel Pump V Series V10



Pump for general purpose lubrication on farms, automotive, workshop & construction sites.

Rugged cast iron construction with machined vanes for better draw & smoother delivery.

Pump Inlet

1"

Pump Outlet

3/4"

Complete with 3 pcs rigid suction tube for use on 50-210 litre drums

WETTED COMPONENTS

Steel, Cast Iron, NBR

RECOMMENDED USE

Heating oils, Motor oils, Lubricating oils, Diesel, Kerosene etc.

DO NO USE WITH

Water based media, Acids, Petrols etc.

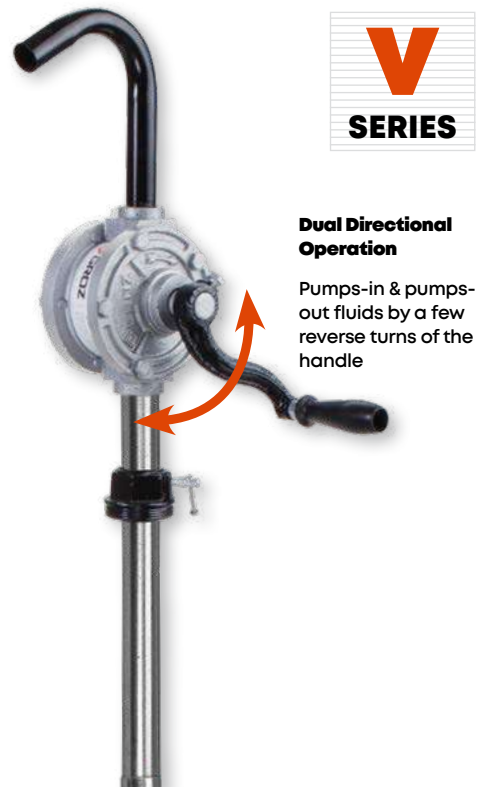

Dual Directional Operation

Pumps-in & pumps-out fluids by a few reverse turns of the handle

ORDERING INFORMATION

CAT NR.	BOX QTY.
V10	4

164 Bucket Oil Pumps

V30 V12
V16



Portable oil pumps designed for dispensing transmission differentials & heavier oils

Pump with variable handle setting for use with media of different viscosities

Includes 48"/4' PVC hose with nozzle

Includes steel drum with a choice of with or without wheels

ORDERING INFORMATION

CAT NR.	BUCKET CAPACITY	BOX QTY.
	(LITRE)	
WITHOUT WHEELS		
V12	12	1
V16	16	1
WITH WHEELS		
V12W	12	1
V16W	16	1
V30W	30	1



165 Bucket Oil Pump with Meter

OLP30-OM10



Pump designed for transferring transmission differentials & heavier oils

Zinc plated pump body with aluminum die cast head & adjusting flange

High pressure positive displacement meter with oval gear mechanism for optimum accuracy

Supplied complete with 30 litres steel bucket, mechanical oil meter, wheels and pull handle

ORDERING INFORMATION

CAT NR.	BUCKET CAPACITY	BOX QTY.
	(LITRES)	
OLP/30/OM10	30	1

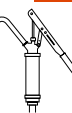



The New Air Operated Fluid Transfer Pump

Ideal for quick & safe transfer of fluids in industrial and workshop applications

Pump complete with:

- Air Pressure Regulator: Factory set at 5 PSI (0.3 BAR) for controlled air supply into the drum
- 1/4" spring loaded safety valve to prevent pressure build-up in the pump system
- 2 Pc Suction Tube: Suitable for use on 50-205 litre drums with 1-1/2" or 2" opening
- 6' (1.85m) x Ø 1" (25mm) discharge hose & steel spout

Available in two versions

	STEEL SUCTION TUBE	STAINLESS STEEL SUCTION TUBE
WETTED COMPONENTS	Steel, Cast Iron, Brass & NBR*	Stainless Steel, Cast Iron, Brass & NBR*
RECOMMENDED USE	Diesel, Kerosene & Oils	Water & Water Based Media, Corrosive media, Diesel, Kerosene & Oils
DO NOT USE WITH	Gasoline, Lacquer, Thinners, etc.	Gasoline, Lacquer, Thinners, etc.

*only for version with discharge hose

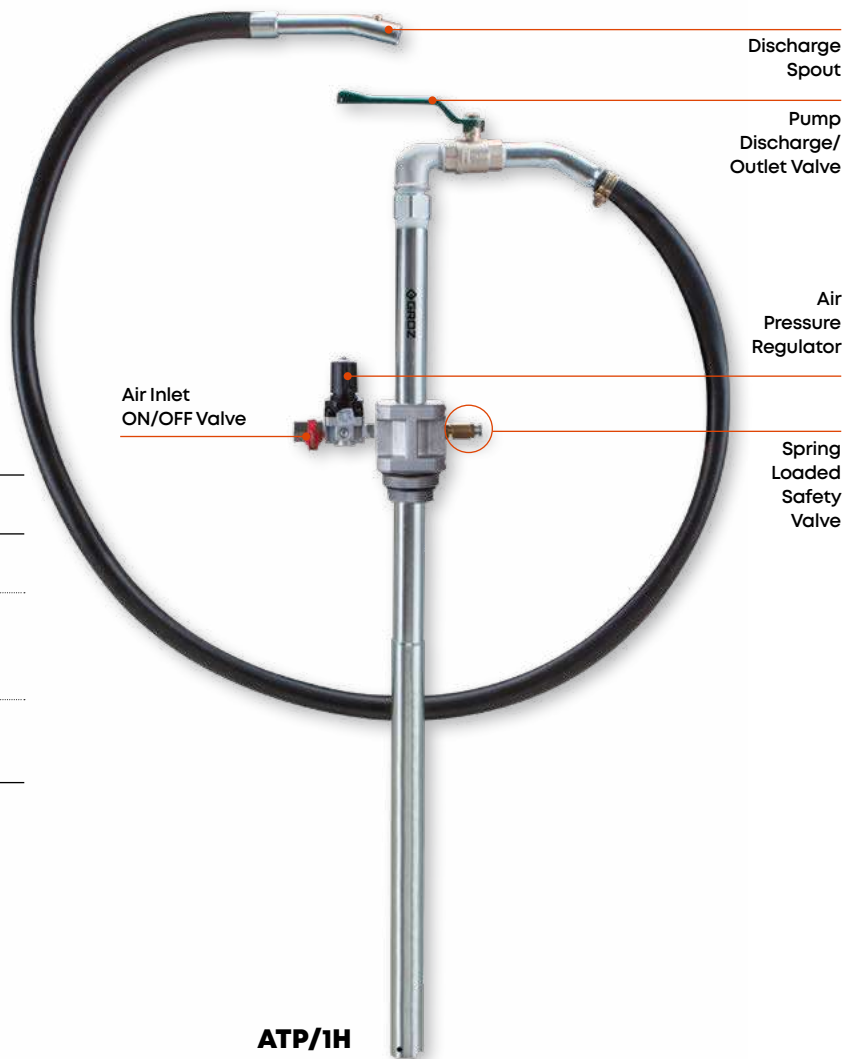

ATP/1H

SPECIFICATIONS

*FLOW RATE	UPTO 45 LPM (UPTO 12 GPM)
MAX. AIR PRESSURE	5 PSI (0.3 BAR)
AIR INLET CONNECTION	1/4" (F)

*Measured at pump outlet tested using water

ORDERING INFORMATION

CAT NR.	DESCRIPTION	BOX QTY.
ATP/1	Pump with steel suction tube	4
ATP/1H	Pump with steel suction tube & discharge hose	4
ATP/SS/1	Pump with stainless steel suction tube	4
ATP/SS/1H	Pump with stainless steel suction tube & discharge hose	4

WARNING

Pump must be supplied with clean & dry compressed air.
The standard pump configuration is also not suitable for use with flammable media such as Gasoline.
For the pump to operate, drum must be sealed ensuring no air outlet to maintain pressure.

167

Air Operated Oil Ratio Pump - 6.5:1

OPH



Heavy Duty Industrial grade pneumatic oil pump designed for unmatched performance in demanding conditions

Dispenses oil upto 6.5 times the pressure as air inlet

All metal construction, fully CNC machined with hardened wear resistant moving parts

Reciprocating piston operated 3" (76 mm) dia. air motor

Stall Free & Ice Free Motor

Tough durable housing with integrated muffler for quiet operation

Single Acting Pump

For dispensing high viscosity oils (upto SAE 240) for transferring over short & long distances (upto 60 metres)

Low Maintenance Pump

Advanced, rugged design with few moving parts & no special maintenance tools make the pump servicing convenient

Stub pump comes complete with 2 additional suction tubes for use on drums upto 205 litre

WETTED COMPONENTS

Steel, Brass, Aluminum, Turcite, Polyurethane, NBR

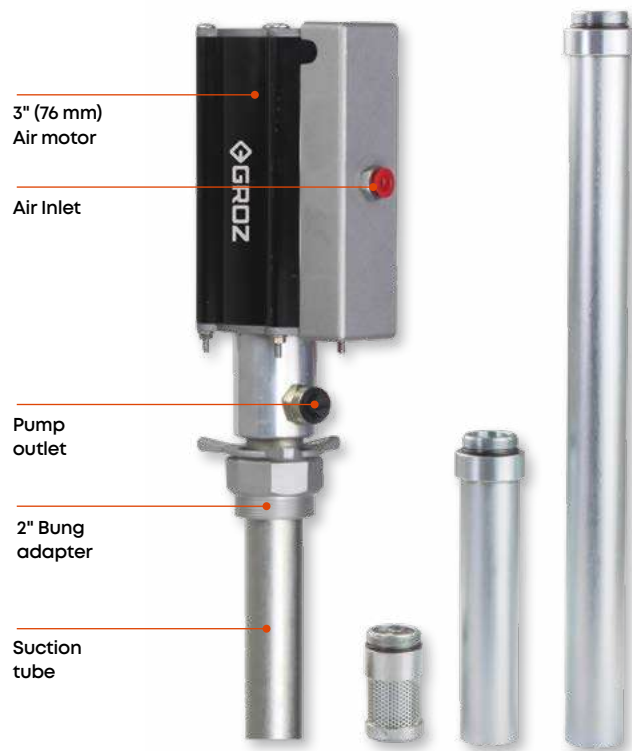

SPECIFICATIONS

WORKING PRESSURE	30-150 PSI (2-10 BAR)
MAX. AIR PRESSURE	150 PSI (10 BAR)
AIR INLET CONNECTION	1/4" BSP (F) / 1/4" NPT (F)
MAX MEDIA OUTLET PRESSURE	975 PSI (65 BAR)
AIR CONSUMPTION	250 LPM
PUMP OUTLET CONNECTION	1/2" BSP (F) / 1/2" NPT (F)
PUMP INLET*	1" BSP (F)/1" NPT (F)
NOISE LEVEL	82 db

* For stub pump only



ORDERING INFORMATION

CAT NR.	THREADS	BOX QTY.
OPH/S-T3/61B/BSP	BSP	4

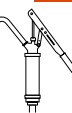

World-class industrial oil dispensing pumps with guaranteed performance & hassle free operation

Pumps are designed to work in tough conditions & are ideal for use in Industry, workshop, farm, construction sites or as part of the mobile oil system

All metal construction, fully CNC machined with hardened wear resistant moving parts

Reciprocating piston operated 63mm dia. air motor

Built in strainer at inlet to keep contaminants away

WETTED COMPONENTS

Steel, Brass, Aluminum,
Hi-Nitrile Rubber, Polyurethane, Turcite* & Nylon**
(*Only On 3:1 & 5:1 Pumps,
**Only On 1:1 Pump)

SPECIFICATIONS

WORKING PRESSURE	30-150 PSI (2-10 BAR)
AIR INLET CONNECTION	1/4" BSP (F)
PUMP OUTLET CONNECTION	1/2" BSP (F)
NOISE LEVEL	81 db
FOR USE WITH	210 litre drums

1:1 PUMPS

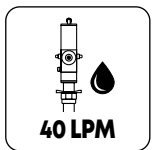

1:1 air operated oil pump designed with a double acting mechanism for quick transfer of oil from large drums to smaller containers with discharge upto 40LPM

Ideal for use with low to medium viscosity (upto SAE 80 Oils) for transferring over short distances (5 metres)

Air Consumption: 270LPM

1:1 pump is also available complete with oil bar tap & connecting links (ODS series), used as an air operated oil dispenser to quickly & conveniently dispense oils from drums

ORDERING INFORMATION

CAT NR.	DESCRIPTION	BOX QTY.
OP/S/11B/BSP	1:1 Pump only	1
OP/T3/11B/BSP	1:1 Pump for 210 litre drums	1
OPK/T3/11B/BSP	1:1 Pump for 210 litre drums complete with 1.5m hydraulic hose & oil control gun	1

Internals Pump

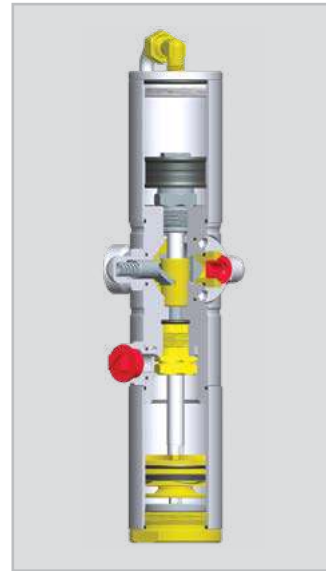

WARNING

Pump must be supplied with clean & dry compressed air via an FRL unit



OP/T3/11B/BSP

OP-11

OP-31

OP-51

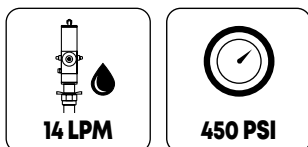
3:1 PUMPS

Amongst the most popular general purpose air operated pumps

Pumps are single acting with discharge upto 14 LPM

Ideal for use with medium to high viscosity oils (upto SAE 130) for transferring over short distances (upto 30 meters), mostly used with Trolley mounted kits

Air Consumption: 230 LPM

ORDERING INFORMATION

CAT NR.	DESCRIPTION	BOX QTY.
OP/S/31B/BSP	3:1 Pump only	1
OP/T3/31B/BSP	3:1 Pump for 210 litre drums	1
OPK/T3/31B/BSP	3:1 Pump for 210 litre drums complete with 1.5m hydraulic hose & oil control gun	1

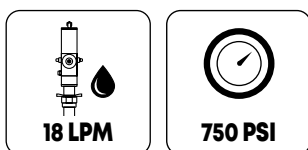
**OP/T3/31B/BSP****5:1 PUMPS**

High pressure air operated pumps for dispensing oil at 5 times the pressure as the air inlet

Pumps are double acting with discharge upto 18LPM

Ideal for use with high viscosity oils (upto SAE 240) for transferring over short & long distances (upto 50 meters),

mostly used with Trolley mounted kits both with & without hose reels, as well as with fixed systems for centralized distribution

Air Consumption: 250LPM

ORDERING INFORMATION

CAT NR.	DESCRIPTION	BOX QTY.
OP/S/51B/BSP	5:1 Pump only	
OP/T3/51B/BSP	5:1 Pump for 210 litre drums	1
OPK/T3/51B/BSP	5:1 Pump for 210 litre drums complete with 1.5m hydraulic hose & oil control gun	1



Double Acting

OP/T3/51B/BSP

169

Air Operated Stainless Steel Ratio Pump - 3:1

OP-SS



Ideal for use with water based fluids, detergents etc. in garages workshops, car washers, lube trucks, industrial applications etc.

Wetted components are made out of stainless steel for protection against corrosion

Reciprocating piston operated 63 mm dia. air motor

Pump has a built in stainless steel strainer at inlet to keep contaminants away

2" die cast aluminium bung for use with 210 litre drums

WETTED COMPONENTS

Stainless Steel, Brass, Aluminium, Hi-Nitrile Rubber, Polyurethane, Turcite

RECOMMENDED USE

Water, water soluble lubricants, coolants, soap solutions, detergents, windshield fluids etc.

DO NOT USE

Food Grade media, waste oil or any media not compatible with the pump components

SPECIFICATIONS

WORKING PRESSURE	30 -150 PSI (2-10 BAR)
MAX. AIR INLET PRESSURE	150 PSI (10 BAR)
AIR CONSUMPTION	230 LPM
AIR INLET CONNECTION	1/4" BSP (F)
PUMP OUTLET CONNECTION	1/2" BSP (F)
NOISE LEVEL	81 db
FOR USE WITH	210 litre drums

ORDERING INFORMATION

CAT NR.	BOX QTY.
OP/T3/SS/BSP	1

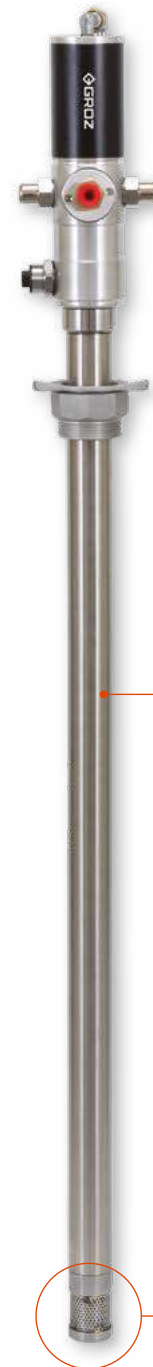

Stainless steel suction tube

Stainless steel strainer

WARNING

Pump must be supplied with clean & dry compressed air via an FRL unit

170

Oil Pump Kits With HD Trolley

TMK-OP

Trolley mounted kits are ideal for use in workshops, garages, shop floors providing complete portability for everyday oiling jobs

Comes with heavy duty drum trolley

KIT INCLUDES

A	Air Operated Oil Ratio Pump
B	Digital Oil Control Gun Aluminium body gun with 1/2" swivel. Includes flexible hose with manual non-drip nozzle Digital Meter: Accuracy $\pm 0.5\%$ Least Count: 0.001 unit
C	Oil Hose Reel - Heavy Duty Dual Arm Hose I.D.: 1/2" (12.7 mm) Hose Length: 10 meter (32.8') Maximum Pressure: 2000 PSI (138 BAR)
D	Drum Trolley - Heavy Duty Manufactured from 4 mm thick steel sheet in powder coated finish Front Wheels: 6" (150 mm) polyurethane with nylon rim Rear castors with toe lock
E	Filter-Regulator Combination with Pressure Gauge (FRC) Port Size: 1/4" Type: Miniature Filter: 40 micron
F	Feeder Hose Connects pump outlet to the hose reel inlet Length: 1.5m (5')
G	Discharge Hose 3.5 m (11") x 1/2" I.D. - SAE R2



SPECIFICATIONS

	TMK/OP3/A/BSP	TMK/OP5H/A/BSP
PUMP RATIO	3:1	5:1
WORKING PRESSURE	30-150 PSI	30-150 PSI
MAX. AIR PRESSURE	150 PSI	150 PSI
FLOW RATE AT PUMP OUTLET	Up to 14 LPM	Up to 18 LPM
LEAST COUNT OF OIL CONTROL GUN	0.001 units	0.001 units
ACCURACY OF METER	$\pm 0.5\%$	$\pm 0.5\%$
REPEATABILITY OF METER	0.30%	0.30%
HOSE	3.5m Hydraulic Hose with 1/2" ID	10m Hose Reel with 1/2" ID
THREAD TYPE	BSP	BSP
AIR CONSUMPTION OF PUMP	230 LPM	250 LPM

ORDERING INFORMATION

CAT NR.	PUMP	BOX QTY.
TMK/OP3/A/BSP	3:1 Air Operated Pump	1
TMK/OP5H/A/BSP	5:1 Air Operated Pump with Hose Reel	1

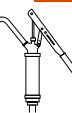

Trolley mounted kits are ideal for use in workshops, garages, shop floors providing complete portability for everyday oiling jobs

Comes with robust drum cart

KIT INCLUDES

A	Air Operated Oil Ratio Pump High pressure pump
B	Digital Oil Control Gun Aluminium body gun with 1/2" swivel. Includes steel extension with automatic non-drip nozzle Digital Meter: Accuracy $\pm 0.5\%$ Least Count: 0.001 unit
C	Discharge Hose 79" x 1/2" I.D. (2m x 12.7 mm I.D.) - SAE R2
D	Oil Hose Reel Hose I.D.: 1/2" (12.7 mm) Hose Length: 10 meter (32.8') Maximum Pressure: 2000 PSI (138 BAR)
E	Drum Cart Manufactured from thick steel sheet in powder coated finish Front Wheels: 10" (250 mm) wide Rear castors with toe lock 5" nylon
F	Feeder Hose Connects pump outlet to the hose reel inlet, Length: 1.5m (5')

TMK1/OP5/B1/BSP
TMK1/OP3/B1/BSP
SPECIFICATIONS

	5:1	3:1
PUMP RATIO	5:1	3:1
FLOW RATE	UPTO 18 LPM	UPTO 14 LPM
WORKING PRESSURE	30-150 PSI (2-10 BAR)	30-150 PSI (2-10 BAR)
AIR INLET CONNECTION	1/4" (F)	1/4" (F)
PUMP OUTLET	1/2" (F)	1/2" (F)
AIR CONSUMPTION	250 LPM	230 LPM
NOISE LEVEL	81 db	81 db
FOR USE WITH	205 L DRUMS	205 L DRUMS

ORDERING INFORMATION

CAT NR.	PUMP	BOX QTY.
TMK1/OP3H/B1/BSP	3:1 Air Operated Pump with Hose Reel	1
TMK1/OP3/B1/BSP	3:1 Air Operated Pump without Hose Reel	1
TMK1/OP5/B1/BSP	5:1 Air Operated Pump	1

TMK1/OP3H/B1/BSP

172

Electric Oil Pumps

OPM

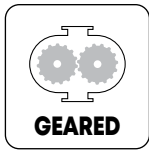

Heavy duty oil pump designed to transfer bulk oils, hydraulic oils, used oil etc

Air cooled motor with thermal protection

Non corroding aluminium die cast pump body

Sintered powder metal gears

Self priming, positive displacement design

High horsepower to flow ratio assures adequate power to pump viscous fluids at low temperatures

Pump has an internal bypass valve to bypass flow, if the discharge pressure exceeds the bypass valve setting

Built-in 2" bung adaptor for mounting on drums/tanks

Can be used to transfer used oil with a screen fitted onto the suction tube

Duty Cycle

30 minutes ON / 30 minutes OFF

Available in following versions

1. AC regular flow
2. AC high flow
3. DC regular flow

WETTED COMPONENTS

Aluminium, Steel, Cast Iron, Nylon, NBR, Zinc, Polypropylene, PVC

RECOMMENDED USE

For oils upto SAE 90, Synthetic Oils, Used Oils, Hydraulic Oils, Cutting Oils, Oil Based Herbicides, Non-Flammable Oil Based Solvents, Liquid Soap etc.

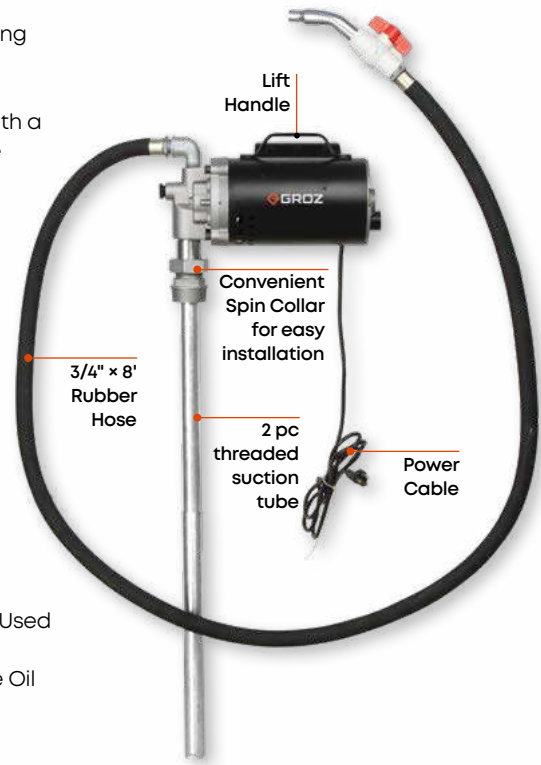

SPECIFICATIONS

	OPM/220	OPM/220/HF	OPM/12
DESCRIPTION	Heavy Duty 220V AC	High Flow Heavy Duty 220V AC	Heavy Duty 12V DC
FLOW RATE	Upto 11.5 LPM	Upto 23 LPM	Upto 13.2 LPM
MOTOR	1/2 HP 220V AC	1/2 HP 220V AC	1/2 HP 12V DC
AMP	6 Amp	6 Amp	39 Amp
RPM	1300	2800	1500
SUCTION PIPE	3/4" long	3/4" long	3/4" long
HOSE	3/4" x 8'	3/4" x 8'	3/4" x 8'
INLET	1" NPT	1" NPT	1" NPT
OUTLET	3/4" NPT	3/4" NPT	3/4" NPT
DISPENSING NOZZLE	Ball valve	Ball valve	Ball valve
POWER CABLE LENGTH	8'	8'	-
MAX WORKING PRESSURE	65 PSI (4.5 BAR)	65 PSI (4.5 BAR)	65 PSI (4.5 BAR)
THERMAL PROTECTION	Yes	Yes	No

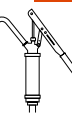



Double Diaphragm Pumps are designed for use in applications requiring large volume transfer in a short time

Driven by compressed air, these can transfer contaminated media & are very useful for cleaning out pits with mixed liquids such as oil, water etc.

Handle a wide variety of fluids with solid content as there are no close fitting or rotating parts

Self Priming

Pump is designed for high suction lift even at dry start up & also with heavier fluids

Ability to run dry, as there are no close fitting or sliding parts

Portable/Simple Installation

Simply connect air supply line & liquid line; pump is ready to perform

Explosion Proof

Safe pumps since they are operated by compressed air

Pumping Efficiency Remains Constant

No rotors, gears or pistons that wear over time, hence no decline in performance

All pump models are designed for use with an inlet air pressure of 20-100 PSI

Air inlet threaded 1/4" NPT (F)

Pumps are available in a choice of 2 materials

- i. Aluminium body with a Hytrel® diaphragm. These can be used for all high temperature applications
- ii. Polypropylene - body with
 - a. Santoprene Diaphragm - for use with abrasives, acids, caustic etc.
 - b. Teflon (PTFE) Diaphragm - for use with fluids such as solvents

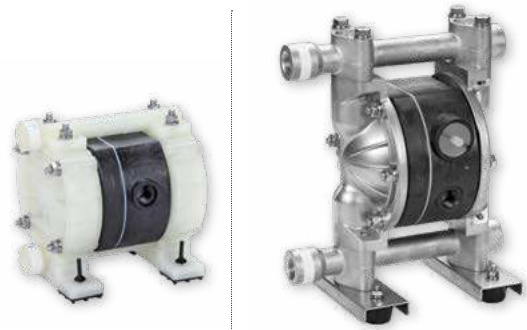

	AODD/1-4/FPT/N	AODD/1-2/BAH/N
SIZE	1/4"	1/2"
CASING	Polypropylene	Aluminium
DIAPHRAGM	PTFE	Hytrel®
FLOW RATE	0-11 LPM	0-50 LPM
PUMP INLET/ OUTLET NPT (F)	1/4"	1/2"
AIR EXHAUST NPT(F)	3/8"	3/8"
MAX PARTICLE SIZE	N/A	1 mm
SUCTION LIFT (DRY)	5-feet	5-feet
MAX AIR CONSUMPTION	250 LPM (8.83 CFM)	450 LPM (15.9 CFM)
WETTED COMPONENTS	Polypropylene, PTFE	Aluminium, PA, Stainless steel, Hytrel®
VALVE BALL MATERIAL	PTFE (Flat type)	Hytrel®
AIR MOTOR	Ryton®	Aluminium
MAXIMUM LIQUID TEMPERATURE	60°C	80°C

Note:

Other materials, configurations and sizes can be custom manufactured on order

TEMPERATURE RANGE FOR VARIOUS MATERIALS

BODY / CASING MATERIAL	LIQUID TEMPERATURE RANGE
ALUMINIUM	0°C to 100°C
POLYPROPYLENE	0°C to 60°C
DIAPHRAGM MATERIAL	LIQUID TEMPERATURE RANGE
HYTREL® (TPEE)	0°C to 80°C
SANTOPRENE® (TPO)	0°C to 90°C
TEFLON® (PTFE)	0°C to 100°C



AODD/1-2/FPT/N	AODD/1-2/FPS/N	AODD/3-4/BAH/N	AODD/3-4/BPS/N	AODD/0-1/BAH/N
1/2"	1/2"	3/4"	3/4"	1"
Polypropylene	Polypropylene	Aluminium	Polypropylene	Aluminium
PTFE	Santoprene®	Hytrel®	Santoprene®	Hytrel®
0-45 LPM	0-45 LPM	0-110 LPM	0-110 LPM	0-110 LPM
1/2"	1/2"	3/4"	3/4"	1"
3/8"	3/8"	3/4"	3/4"	3/4"
N/A	N/A	2.0 mm	2.0 mm	2.0 mm
8-feet	8-feet	18-feet	18-feet	18-feet
350 LPM (12.4 CFM)	350 LPM (12.4 CFM)	1200 LPM (42.4 CFM)	1200 LPM (42.4 CFM)	1200 LPM (42.4 CFM)
Polypropylene, PTFE	Polypropylene, PTFE	Aluminium, Stainless steel Hytrel®	Polypropylene, Santoprene®	Aluminium, Stainless steel, Hytrel®
PTFE (Flat type)	PTFE (Flat type)	Hytrel®	Santoprene®	Hytrel®
Ryton®	Ryton®	Aluminium	Glass-filled polypropylene	Aluminium
60°C	60°C	80°C	60°C	80°C

ORDERING INFORMATION

CAT NR.	SIZE	CASING	DIAPHRAGM	RECOMMENDED FLUIDS	BOX QTY.
AODD/1-4/FPT/N	1/4"	Polypropylene	PTFE	Windshield Washer Fluid, Caustic Soda, Sulfuric Acid (Up To 75%), Plating Solution, Photograph Developing Liquid, Benzene, Hydrogen Peroxide, Waste Water Etc.	1
AODD/1-2/BAH/N	1/2"	Aluminium	Hytrel®	Diesel Fuel, Kerosene, Lubricants, Gear Oil, Engine Oil, Waste Oil, Brake Fluid, Naphtha, Mold Lubricants, Antifreeze And Waste Water	1
AODD/1-2/FPT/N	1/2"	Polypropylene	PTFE	Windshield Washer Fluid, Caustic Soda, Sulfuric Acid (Up To 75%), Plating Solution, Photograph Developing Liquid, Benzene, Hydrogen Peroxide, Waste Water Etc.	1
AODD/1-2/FPS/N	1/2"	Polypropylene	Santoprene®	Ethanol, Ammonium Hydroxide And Waste Water	1
AODD/3-4/BAH/N	3/4"	Aluminium	Hytrel®	Diesel Fuel, Kerosene, Lubricants, Gear Oil, Engine Oil, Waste Oil, Brake Fluid, Naphtha, Mold Lubricants, Antifreeze And Waste Water	1
AODD/3-4/BPS/N	3/4"	Polypropylene	Santoprene®	Ethanol, Ammonium Hydroxide And Waste Water	1
AODD/0-1/BAH/N	1"	Aluminium	Hytrel®	Diesel Fuel, Kerosene, Lubricants, Gear Oil, Engine Oil, Waste Oil, Brake Fluid, Naphtha, Mold Lubricants, Antifreeze And Waste Water	1



Upgrade your workshop today!

Centralized control of new and waste oil management

Alerts when tanks require refelling or drainage

Each unit can monitor upto 8 dispensing outlets





Provides automated tracking and monitoring of the lubrication room for accurate oil dispensing and also prevents wastage of oil due to any human error







AN IDEAL 4 BAY SYSTEM MUST INCLUDE

NAME OF COMPONENT	OIL RATIO PUMP	HOSE REEL	OIL CONTROL GUN	SOLENOID VALVE
SPECIFICATIONS	World-class Industrial 5:1 Oil Dispensing Pumps with guaranteed performance & hassle free operation	All metal 10m or 15 m hose reels with Heavy duty dual ratchet to reduce stress on spring smooth & balanced operation during hose extension & retraction. Can lock hose in multiple usable positions	With or without meter having built-in continuous flow switch that can be activated for unattended dispensing	Flow range: 0 to 50 l/min Operating Pressure: Max 207 bar Inlet/Outlet connections : 1/2" BSP
QTY.	4	4	4	4

CONFIGURATION GUIDE

							
NO OF POINTS / COMPONENTS	POWER SUPPLY INTERFACE	CONTROL KEYPAD	SOLENOID VALVE	PULSE METER	OIL RATIO PUMP	HOSE REEL	OIL CONTROL GUN
ONE POINT SYSTEM	1	1	1	1	1	1	1
TWO POINTS SYSTEM	1	1	2	2	2	2	2
THREE POINTS SYSTEM	1	1	3	3	3	3	3
FOUR POINTS SYSTEM	1	1	4	4	4	4	4
FIVE POINTS SYSTEM	1	1	5	5	5	5	5
SIX POINTS SYSTEM	1	1	6	6	6	6	6
SEVEN POINTS SYSTEM	1	1	7	7	7	7	7
EIGHT POINTS SYSTEM	1	1	8	8	8	8	8
NINE POINTS SYSTEM	1	2	9	9	9	9	9
TEN POINTS SYSTEM	1	2	10	10	10	10	10
ELEVEN POINTS SYSTEM	1	2	11	11	11	11	11
TWELVE POINTS SYSTEM	1	2	12	12	12	12	12
THIRTEEN POINTS SYSTEM	1	2	13	13	13	13	13
FOURTEEN POINTS SYSTEM	1	2	14	14	14	14	14
FIFTEEN POINTS SYSTEM	1	2	15	15	15	15	15
SIXTEEN POINTS SYSTEM	1	2	16	16	16	16	16

			
PULSE METER	CONTROL KEYPAD	CONTROLLER SOFTWARE	POWER SUPPLY INTERFACE
<p>Electric oval gear meter suitable for monitoring the delivery of oils with a wide range of viscosity.</p> <p>Flow Rate: Upto 30 L/Min</p> <p>Operating Pressure: Max 70 Bar</p> <p>Repeatability: 0.3%</p> <p>Accuracy: ± 0.5%</p>	<p>A single Control Keypad can monitor up to 8 different outlets dispensing</p>	<p>Easy to operate software interface offering outlet dispensing activated directly from the PC software</p>	<p>A single power supply gives enough power to run up to eight outlets</p>
4	1	1	1

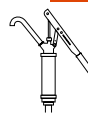

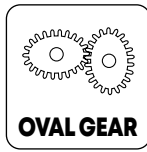
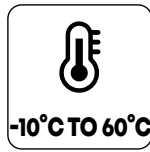
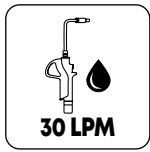

High pressure positive displacement meter suitable for in-line and end of line applications

Oval gear mechanism for optimum accuracy

High reliability Mechanical Display

Robust Aluminum Die Cast construction with protective shroud on meter

WETTED COMPONENTS

Aluminum, Stainless Steel, Nitrile Rubber & POM

RECOMMENDED USE

Oils with viscosity upto 2000 cSt, Diesel, Biodiesel

DO NOT USE WITH

Water based media, Gasoline etc.



SPECIFICATIONS

ACCURACY	±1%
REPEATABILITY	±0.20%
BURST PRESSURE	3000 PSI (210 BAR)
PRESSURE LOSS	10 PSI (0.7 BAR)
UNITS OF MEASURE	Litres
MAX. RESETTABLE BATCH TOTAL	999.9 Units
MAX. NON RESETTABLE TOTALIZER	999999.9 Units
LEAST COUNT / RESOLUTION	0.10 Units
WATER RESISTANCE	IP55

Note: Not to be used to measure media for resale

ORDERING INFORMATION

CAT NR.	MEASUREMENT	THREADS	BOX QTY.
OM/10/1-2/BSP	Litres	1/2" BSP (F)	1
OM/10/1-2/N	Litres	1/2" NPT (F)	1

176 Mechanical Oil Control Gun OGN-OM10

30 LPM

1,000 PSI

-20°C TO 70°C

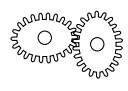
OVAL GEAR

Super accuracy heavy duty gun for controlling fluid deliveries in most demanding applications

Oval gear mechanism

High Reliability Mechanical display

Aluminium Die cast meter & gun body

Built-in continuous flow switch can be activated for un-attended dispensing

Swivel at inlet for easy maneuverability. Strainer in the swivel keeps contaminants, dust, grit etc. away from entering the gun

Supplied complete with rigid steel extension and manual non drip nozzle

WETTED COMPONENTS
 Aluminum, Steel, Brass, Stainless Steel, NBR & Acetal

RECOMMENDED USE
 Oils with viscosity upto 2000 CST

DO NOT USE WITH
 Water based media, Gasoline etc

SPECIFICATIONS

ACCURACY	±1%
REPEATABILITY	±0.20 %
MAX. RESETTABLE BATCH TOTAL	999.9 Litres or Quarts
MAX. NON RESETTABLE TOTALIZER	999999.9 Litres or Quarts (7 Digit)
LEAST COUNT /RESOLUTION	0.10 Litres or Quarts
INLET THREADED	1/2" BSPT (F) / 1/2" NPT (F)
IN-LINE SWIVEL	1/2" (F)
OUTLET DIAMETER OF STEEL SPOUT	1/2" (12.7 mm)
INSIDE DIAMETER OF HOSE EXTENSION	1/2" (12.7 mm)

Note: Not to be used to measure media for resale

ORDERING INFORMATION

CAT NR.	BOX QTY.
OM/10/OGN/RM/B	1



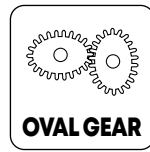
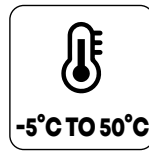
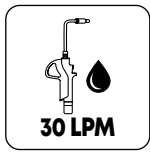

Heavy duty oil control gun with robust aluminium construction

Electronic preset design; works on 4 x 1.5V AA batteries

Dual Mode: Manual & Pre-Set (dispenses set quantity of media & stops)

Oval gear mechanism for optimum accuracy

Adjustable outlet nozzle can be positioned for in-line or 90° dispensing

Resettable totalizer for individual batch can be set in litres, quarts, pints & gallons

A second resettable totalizer for multiple dispensing operations can be set in litres, quarts, pints & gallons with max. pre-set volume of 99.9 units

Lifetime non-resettable totalizer can be set in litres

Built-in swivel at Inlet fitted with strainer

Supplied complete with steel extension with built-in non drip tip

WETTED COMPONENTS
Aluminium, Steel, Stainless Steel, Brass, Polyurethane, Acetic Resin, Hi Nitrile Rubber

RECOMMENDED USE
Oils with viscosity in the range of 10 to 5000 cst, Diesel

DO NOT USE WITH
Petrol, Windshield Fluids etc.



SPECIFICATIONS

INLET	1/2" BSP (F)
ACCURACY	± 0.50%
REPEATABILITY	± 0.20%
MINIMUM PRE SET QTY.	0.10 Units
MAXIMUM PRE SET QTY.	99.9 Units
MAX. RESETTABLE BATCH TOTALIZER	999.9 Units
MAX. NON RESETTABLE BATCH TOTALIZER	9999.9 Units
VISCOSITY OF MEDIA DISPENSED	10 to 5000 cst
RESOLUTION / LEAST COUNT	0.005 litre
WATER RESISTANCE	IP55

Note: Not to be used to measure media for resale

ORDERING INFORMATION

CAT NR.	BOX QTY.
OM/300/PS/RA/BSP	1

178

Oil Control Guns

OGN

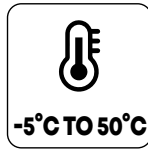

Heavy duty gun for controlling fluid deliveries in most demanding applications

Aluminium die cast construction

Built-in continuous flow switch can be activated for unattended dispensing

Swivel at inlet for easy manoeuvrability. Strainer in the swivel keeps contaminants, dust, grit etc. from entering the gun

WETTED COMPONENTS

Aluminum, Steel, Brass & NBR

RECOMMENDED USE

Oils with viscosity upto SAE 140

DO NOT USE WITH

Water based media, Petrol etc.

VARIANTS

OGN/SA/1-2R/B	OGN/SM/1-2R/B
	
With Steel Extension & Automatic Non Drip Nozzle	With Steel Extension & Manual Non Drip Nozzle

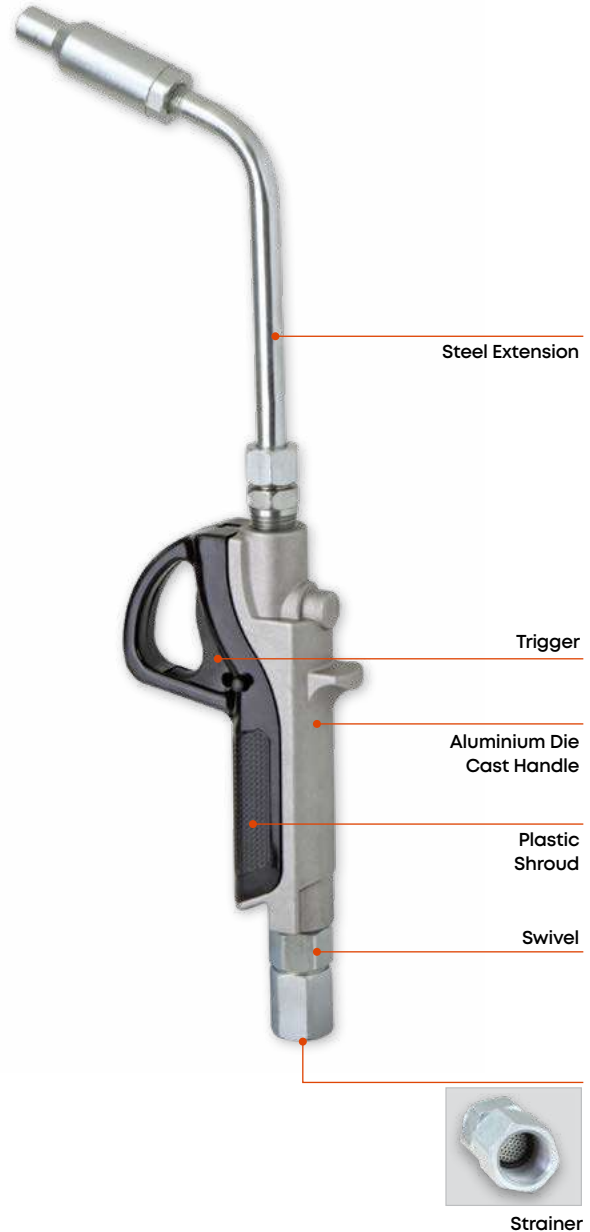

ORDERING INFORMATION

CAT NR.	BOX QTY.
OGN/SA/1-2R/B	1
OGN/SM/1-2R/B	1

SPECIFICATIONS

INLET THREADS	1/2" BSPT (F) / 1/2" NPT (F)
IN-LINE SWIVEL	Included
OUTLET DIAMETER OF STEEL SPOUT	1/2" (12.7 mm)
INSIDE DIAMETER OF HOSE EXTENSION	1/2" (12.7 mm)

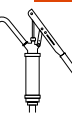

179 Transfer Gun SG-20

Dual action transfer gun: draws in & pumps out liquids in a single stroke

Easy & safe answer to fluid transfer, especially useful in transferring media unsafe for body contact

Gun body is non-denting & is made from heavy aluminum section. Suction head & piston have an aluminum construction & use viton piston rings

WETTED COMPONENTS

Aluminum, Brass, Viton, PVC

RECOMMENDED USE

Fuel Oils, Mineral Oils, Synthetic & Biological Oils, Petrol, Coolants, Water, Spirits & Brake Fluids



Complete with 8' of Vinyl Hose (4' with each valve)

ORDERING INFORMATION

CAT NR.	CAPACITY	BOX QTY.
	(ML)	
SG/20	350	20

180 Oil Cans V Series 181 Hydraulic Oil Hoses

Tin coated steel body in premium powder coated finish

Steel pump with double ball check

Useful for convenient dispensing of oil

Complete with 150 mm (6") rigid steel spout



ORDERING INFORMATION

CAT NR.	CAPACITY	BOX QTY.
	(ML)	
V200R	200	72
V300R	300	72
V500R	500	72

Hydraulic Rubber Hoses for use with Air Operated Oil Pumps

Hose exceeds SAE 100 R1 specification

Working Pressure 2,200 PSI (150 BAR)

Inner Dia: 1/2"
Outer Dia: 7/8"

Hydraulically crimped with steel fittings with 1/2" (M) threads on both ends



ORDERING INFORMATION

CAT NR.	LENGTH	THREADS	BOX QTY.
	(M)		
HH/1.5/1-2M/BSP	1.5	1/2" BSP (M)	1
HH/2.5/1-2M/BSP	2.5	1/2" BSP (M)	1
HH/1.5/1-2M/3-8M/BSP	1.5	1/2" BSP (M) 1 3/8" BSP (M)	1

182

Measuring Jugs

JUG

NEW!

Handy measuring jugs suitable for industrial and automotive applications

Heavy-duty clear and transparent polypropylene body with exceptional optical clarity. Usage of food-grade polymer makes these useful in the food industry too

Special design ensures that it can shipped in nested form

Strong and sturdy handle with ergonomic thumb grip for convenient usage

Graduated in Litres and Ounces



Highly resistant to acids, bases and chemicals, these are autoclavable at 121°C (250°F). Can be safely used in a microwave without fear of any deformation



COMPATIBILITY CHART

ACIDS, DILUTE OR WEAK	Excellent
ACIDS, STRONG AND CONCENTRATED	Excellent
ALCOHOLS	Excellent
ALDEHYDES	Very Good
BASES	Excellent
HYDROCARBONS	Very Good
OXIDIZING AGENTS, STRONG	Not Recommended

AVAILABLE SIZES

JUG/1G	JUG/2G
	
1000 ml (32 oz.)	2000 ml (64 oz.)

ORDERING INFORMATION

CAT NR.	CAPACITY		BOX QTY.
	(ML)	(OZ.)	
JUG/1G	1000	32	20
JUG/2G	2000	64	20

Note
Jugs must not be used to measure media for sale / commercial use



Shipped in nested form

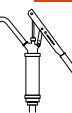

183

Flexible Spout Measures

MSR

High density translucent polyethylene construction

Used for transferring measured quantity of fluid

Supplied complete with polyethylene flexible spout with cap and polypropylene lid

Not to be used for measuring media for sale



ORDERING INFORMATION

CAT NR.	CAPACITY	BOX QTY.
	(LITRES)	
MSR/P/F-1	1	40
MSR/P/F-2	2	25
MSR/P/F-3	3	20
MSR/P/F-5	5	15
MSR/P/F-6	6	12
MSR/P/F-8	8	12

184

Smart Funnels

FNL-8

FNL-9

High density translucent polypropylene construction

Designed with special contours in the funnel body for easy handling

Anti-splash & spill proof, with curved rim

Complete with wire mesh screen, dust cover & flexible spout

Available in 2 sizes

- a. Funnel only
- b. Funnel with bung attachment for direct mounting on drums with 2" opening



Direct mounting on drums with 2" opening

ORDERING INFORMATION

CAT NR.	DESCRIPTION	CAPACITY	BOX QTY.
		(LITRES)	
FNL/8	Funnel only	1.7	15
FNL/9B	Funnel with bung	3	15

FNL/8
Capacity 1.7 litres
Dia 8" (250mm)

FNL/9B
Capacity 3.0 litres
Dia 9-1/2" (240mm)

185

Fuel & Oil Funnels

FNL-11

High flow fuel & oil funnel with extra large mouth for easy pouring

Heavy Duty polyethylene construction for outdoor use over varying temperature conditions

RECOMMENDED USE

Diesel, Gasoline, Kerosene, Urea, Antifreeze & Water

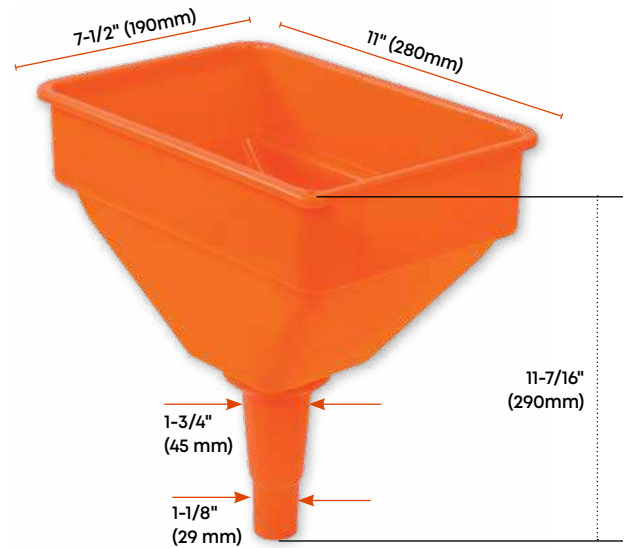

Filter Screen



ORDERING INFORMATION

CAT NR.	CAPACITY	BOX QTY.
	(LITRE)	
FNL/11F	4.7	15

186

Conical Funnels

FNL-6

FNL-7

Polyethylene funnels designed for use with virtually any media. Will never corrode or rust

WETTED COMPONENTS

Polyethylene

RECOMMENDED USE

Diesel, Gasoline, Kerosene, Urea, Oils, Antifreeze & Other Water based media.

DO NOT USE WITH

Acids & other media at temperatures above 60°C



FNL/7



FNL/6

ORDERING INFORMATION

CAT NR.	CAPACITY	HEIGHT (H)		D		D1		D2		BOX QTY.
	(ML)	(INCH)	(MM)	(INCH)	(MM)	(INCH)	(MM)	(INCH)	(MM)	
FNL/6	650	6	153	5-3/4	146	9/16	14	7/8	22	60
FNL/7	1800	8-11/32	214	8-11/32	212	1-1/8	28.9	1-7/8	46.5	40



Polypropylene funnels designed for quick & drip-free transfer of variety of fluids

High rim works as an effective splash guard

Sold as a set of 4

RECOMMENDED USE

Diesel, Gasoline, Kerosene, Urea, Oils, Antifreeze & Other Water based media.

DO NOT USE WITH

Acids & other media at temperatures above 60°C (140°F)



SET INCLUDES 4 FUNNELS



DIA (D)		CAPACITY	
(INCH)	(MM)	(ML)	(OZ.)
5	125	430	15
4	100	245	8.5
3	75	120	4.2
2	50	40	1.4

ORDERING INFORMATION

CAT NR.	BOX QTY.
FNL/4/ST	50

188

Flexible Funnel

FNL-FX

NEW!

Flexible funnel to transfer a wide variety of media in industrial, agriculture, automotive & DIY applications.

Constructed from high grade PVC

Can be folded into any shape to drain and refill liquid without mess

After use, just wipe it clean, roll up & store in the tool box

Use with oils, kerosene, diesel, gasoline, water and water based fluids

Ideal for transferring oil, and other liquids in cars, trucks, motorcycles, ATVs, industrial equipment, lawns and forklifts



COMPACT DESIGN



Roll up & store in the tool box

USER CONVENIENCE



Can be folded into any shape



ORDERING INFORMATION

CAT NR.	NET WEIGHT	DIMENSIONS		BOX QTY.
	(KG)	(INCH)	(MM)	
FNL/FX/37-17	0.26	14-9/16 × 6-11/16	370 × 170	50

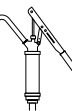

All metal hose reels

Ribbed steel design prevents bending & flexing. Rolled edges for added strength & stability

Compact design allows these to be used in confined spaces with ease

Casseted Spring Design

Drive springs are manufactured from highest quality spring steel that ensures long life. Precise manufacturing guarantees a superior quality edge

Fully enclosed cassetted design makes the spring resistant to corrosion caused by water & dirt, guaranteeing longer life & trouble free operation. Convenient & safe maintenance

Heavy Duty Dual Ratchet

Reduces stress on spring providing smooth & balanced operation during hose extension & retraction. Ratchet teeth can lock hose in multiple usable positions

Multiple Position Guide Arm

Guide arms can be adjusted at 45° intervals for floor, wall or truck mounting with a convenient mounting angle for hose to be released at optimum position

Reels are available With

- a. **Dual Guide Arm:** Medium & high pressure applications involving grease & oils. Dual guide arm design is structurally reinforced strengthened with metal ribs that prevent flexing and bending due to hose pull
- b. **Single Guide Arm:** For low pressure applications involving air and water

Adjustable roller guide arm with removable nylon guide rollers reduces drag & wear

Inlet swivel reduces torque load on power spring for smoother hose movement & durability

1/4" (6.35 mm) thick steel base with easy mounting eyelet hole

All components are powder coated after cleaning, degreasing & iron phosphate penetrating ensuring a long lasting, durable & attractive finish

Hose Reel accessories for floor mounting & angular mounting on walls are also available

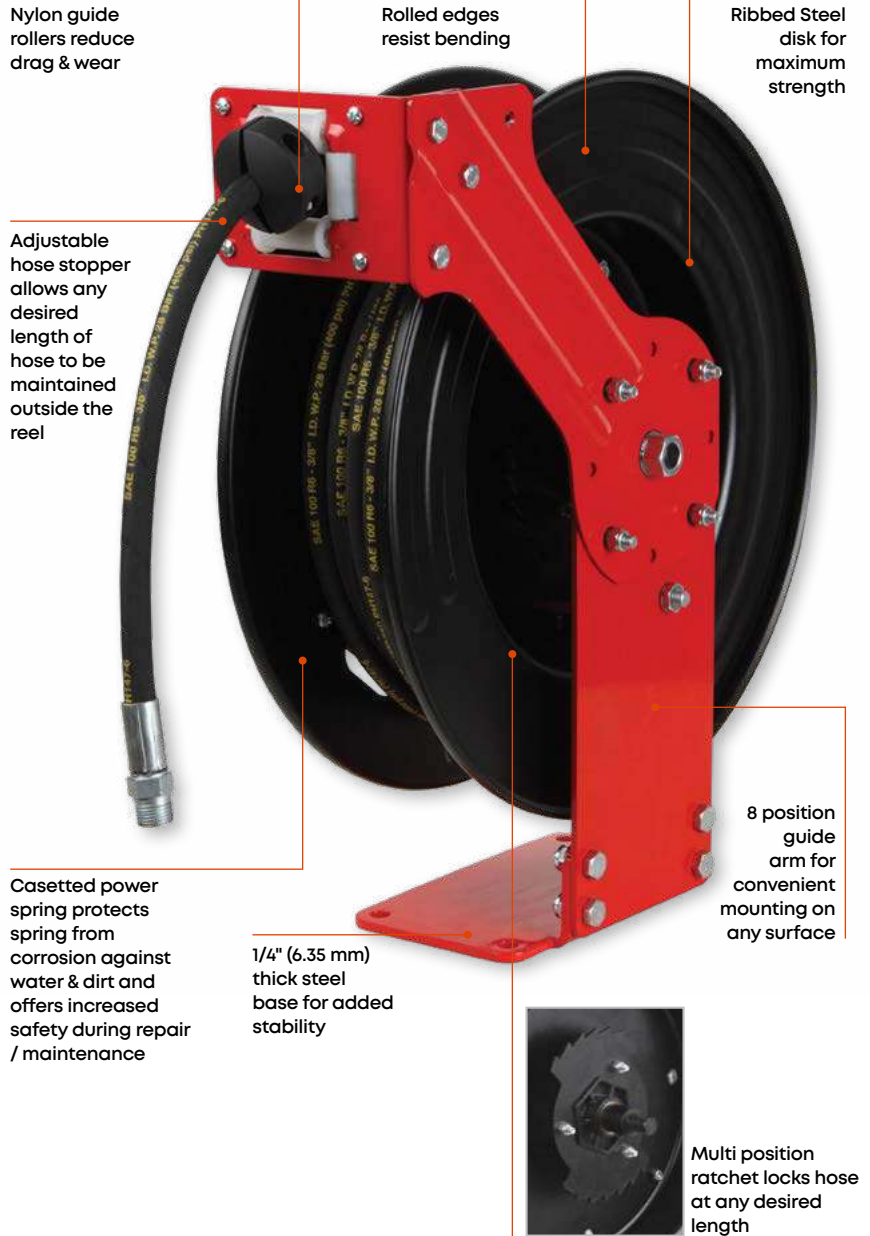

MOUNTING BRACKET OPTIONS

SWV/HR/360 47950	SWV/HR/140 47951
Floor Mounting Bracket (available as spare)	Wall Mounting Bracket (available as spare)

HR-AW

HR-OL

HR-GR

VARIANTS

AIR / WATER
LOW PRESSURE
HOSE REELSOIL / MEDIUM
PRESSURE
HOSE REELSGREASE / HIGH PRESSURE
HOSE REELS

Hose Reel Bolt Pattern

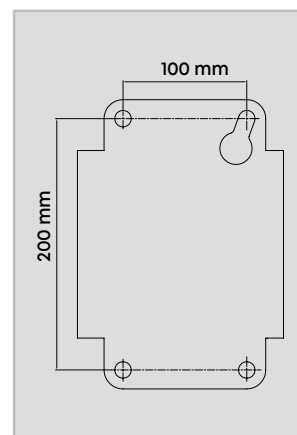

ORDERING INFORMATION

CAT NR.	MAX. PRESSURE	INLET/ OUTLET THREADS	HOSE ID		HOSE OD		HOSE LENGTH	BOX QTY.
			(INCH)	(MM)	(INCH)	(MM)		
AIR/WATER - LOW PRESSURE HOSE REELS								
HR/AW/10M/3-8/B	300 PSI	3/8	3/8	9.5	5/8	15.9	10	1
HR/AW/15M/3-8/B	300 PSI	3/8	3/8	9.5	5/8	15.9	15	1
HR/AW/10M/1-2/B	300 PSI	1/2	1/2	12.7	3/4	19	10	1
HR/AW/15M/1-2/B	300 PSI	1/2	1/2	12.7	3/4	19	15	1
OIL - MEDIUM PRESSURE HOSE REELS								
HR/OL/10M/3-8/B	2,000 PSI	3/8	3/8	9.5	23/32	18.1	10	1
HR/OL/15M/3-8/B	2,000 PSI	3/8	3/8	9.5	23/32	18.1	15	1
HR/OL/10M/1-2/B	2,000 PSI	1/2	1/2	12.7	7/8	21.5	10	1
HR/OL/15M/1-2/B	2,000 PSI	1/2	1/2	12.7	7/8	21.5	15	1
GREASE - HIGH PRESSURE HOSE REELS								
HR/GR/10M/1-4/B	5,800 PSI	1/4	1/4	6.35	5/8	15.9	10	1
HR/GR/15M/1-4/B	5,800 PSI	1/4	1/4	6.35	5/8	15.9	15	1
HR/GR/10M/3-8/B	4,000 PSI	3/8	3/8	9.5	3/4	19	10	1
HR/GR/15M/3-8/B	4,000 PSI	3/8	3/8	9.5	3/4	19	15	1

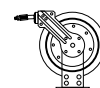

190

Auto-Retractable Air/Water Hose Reel

NEW!

Keep your shop organized.
Eliminate hose tripping hazards

Built to last

Durable steel construction with powder coated finish that resists corrosion making these suitable for both indoor & outdoor usage

Adjustable roller guide arm with removable nylon guide rollers reduces drag & wear

Brass inlet/outlet joints with swivel at inlet for smoother hose movement

Maintenance free design

Fully enclosed design makes the spring resistant to corrosion caused by water & dirt, guaranteeing longer life & trouble free operation. Convenient & safe maintenance

Ratchet

- Dual ratchet teeth can lock hose in multiple positions
- Dual ratchet reduces stress on spring for smooth & balanced operation

Hose Guide

Guide arms can be adjusted at 45° intervals for versatile mounting options

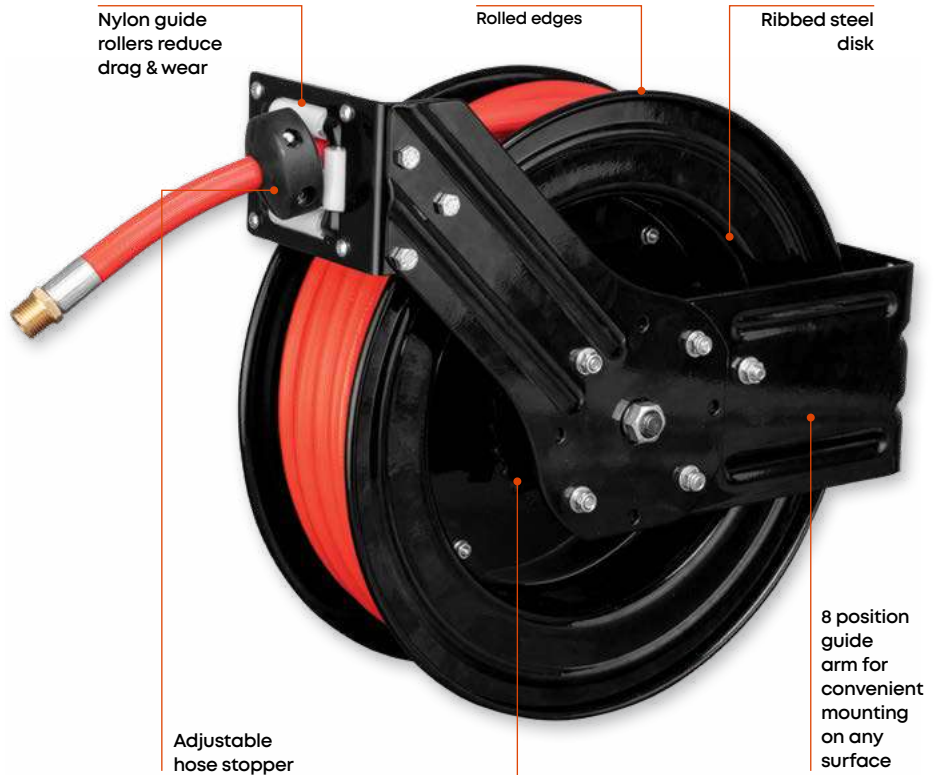

Multi position ratchet locks hose at any desired length

AIR HOSE SPECIFICATIONS

WORKING PRESSURE	300 PSI (20 BAR)
WORKING TEMPERATURE	-15°C TO 70°C
TYPE	Special formulated material
REINFORCEMENT MATERIAL	Polyester

ORDERING INFORMATION

CAT NR.	MAX. PRESSURE		INLET / OUTLET THREADS	HOSE ID			HOSE OD		HOSE LENGTH		WEIGHT		BOX QTY.
	(PSI)	(BAR)		(INCH)	(MM)	(INCH)	(MM)	(M)	(FEET)	(KG)	(LBS)		
HRE/AW/10M/3-8/B	300	21	3/8	3/8	9.5	5/8	15.9	10	32.8	14.4	31.75	1	
HRE/AW/15M/3-8/B	300	21	3/8	3/8	9.5	5/8	15.9	15	49.2	14.4	31.75	1	

191

Air / Water Hose Reel

HRP-AW

Safe storage system that keeps hoses off the floor, reducing wear and tear of costly hose, prevents accidents and keeps workplace CLUTTER FREE

Compact & Fully Enclosed Design

- Fully enclosed design protects the inner spring from water & dirt
- Compact size allows these to be used in confined spaces with ease
- The Top cover discreetly hides the handle yet makes it easily accessible
- Drive spring – superior choice of material, control hardness, moment of force makes these durable and long lasting

Auto Roll-Up

Equipped with slow rewinding mechanism ensuring no injury to the user.

Hose can be locked at any desired position

180° Swivel Wall Bracket

Easily fix the bracket on the wall using screws

Hose reel can swivel 180° on the bracket and can be adjusted in the desired angle

User can change the hose easily as per its needs/application



SPECIFICATION

CASE MATERIAL	Polypropylene
HOSE LENGTH	15 meter (50 ft.)
HOSE MATERIAL	Hybrid (Nitrile + PVC)
HOSE I.D.	3/8" (10 mm)
THREAD SIZE	1/4" BSPT
WORKING PRESSURE	217 PSI (15 Bar)
BURST PRESSURE	580 PSI (40 Bar)
OPERATING TEMPERATURE	-5°C to 45°C (23°F to 113°F)

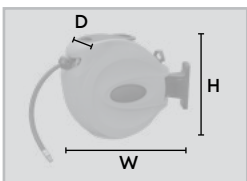

ORDERING INFORMATION

CAT NR.	SIZE (W×D ×H)		BOX QTY.
	(INCH)	(MM)	
HRP/AW/15M/3-8/B	14-7/8 × 7-1/4 × 13-1/4	378 × 185 × 335	1

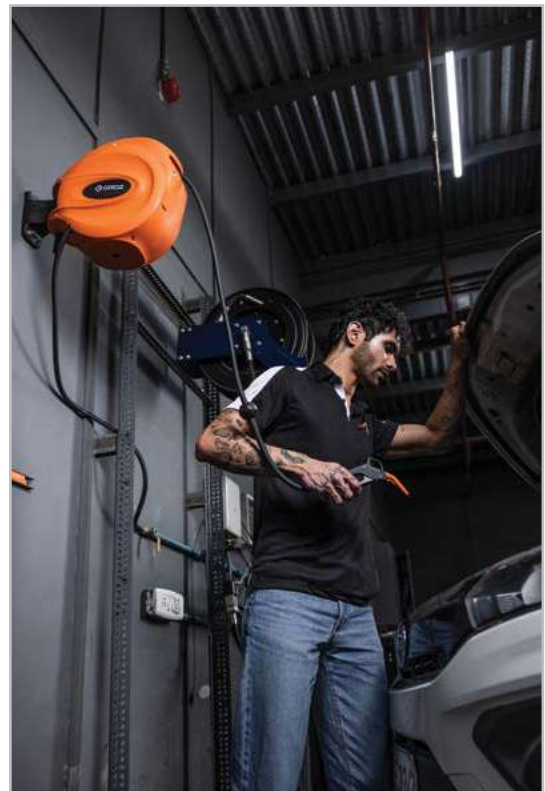

Electric Pump for waste oil evacuation

Flexible impeller design enables pumping high viscosity fluids at high flow rate

Motor with thermal overload protection to prevent over heating

Self priming ZAMAC body can handle a wide variety of fluids

Suction and Discharge Ports

Dual threads:
3/8" NPT thread (F) and
3/4"-11.5 NH(M)

Ideal for pumping used engine oil, transmission oil, hydraulic oil etc.

Available in the following options

- a. 220V, 50Hz AC
- b. 12V DC

Duty Cycle

45 min ON / 45 min OFF

WETTED COMPONENTS

ZAMAC, Stainless Steel, Nitrile Rubber, Neoprene

RECOMMENDED USE

Used Oil, Engine Oil, Transmission Oil, Hydraulic Oil, Water, Ethylene Glycol

DO NOT USE WITH

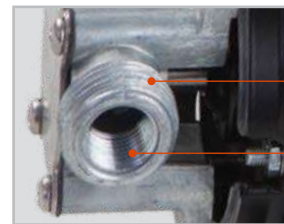

Gasoline, any flammable media



3/4" Garden
Hose Thread (M)

3/8" NPT
Thread (F)

VARIANTS

	EWOP/220/EU	EWOP/12
		
FLOW RATE	23 LPM	17 LPM
MAX. PRESSURE*	18 PSI (1.25 BAR)	18 PSI (1.25 BAR)
SUCTION LIFT (DRY/WET)	6' (182 cm) /8' (243 cm)	6' (182 cm) /8' (243 cm)
DISCHARGE HEAD (WATER)	40' (12.2m)	40' (12.2m)
MAX. VISCOSITY	2000 SSU (SAE 30)	2000 SSU (SAE 30)
POWER CABLE LENGTH	6' (182 cm)	N/A

*As pressure increases the flow rate will decrease

ORDERING INFORMATION

CAT NR.	INPUT POWER	BOX QTY.
EWOP/220/EU	220V, 50HZ AC	4
EWOP/12	12V DC	4

193

Air Operated Double Diaphragm Pumps

AODD

Specifically engineered with reduced parts ensuring maximum performance & reliability. These are used for transfer of clean & particulate laden fluids including waste oil in industrial, automotive, chemical processing, oil & gas and marine applications

Truly Non-lubricated Design

A non lubricated outside accessible air distribution system with no messy pre-packed grease

Energy saving

20% less air consumption over conventional pumps

Fully bolted design

Quick tear down & rebuild, Hence negligible downtime during operation

20% Fewer wearing parts

Low periodic maintenance is required

Self Priming

The pump design (incorporating internal check valves) allows for high suction lift even at dry start-up and with heavier fluids

Explosion Proof



As pumps are operated by compressed air, therefore, they are intrinsically safe

Submersible

If external components are compatible - these pumps can be submerged in the liquid by simply running the exhaust line above the liquid level

Ideal for transfer of waste oil in workshops, garages etc.

VARIANTS

	AODD/25/BAH/N	AODD/15/BAH/N	AODD/15/BPS/N
			
SIZE	1"	1/2"	1/2"
CASING	Aluminum	Aluminium	Polypropylene
DIAPHRAGM	Hytrel	Hytrel	Santoprene
FLOW RATE	Upto 140 LPM (37 GPM)	Upto 58 LPM (15.3 GPM)	Upto 55 LPM (14.5 GPM)
PUMP INLET/OUTLET (F)	1" Opening	1/2" Opening, 4 inlets & 4 outlets	1/2"
AIR INLET	3/8"	1/4"	1/4"
AIR INLET PRESSURE	29 - 100 PSI (2 - 7 BAR)	29 - 100 PSI (2 - 7 BAR)	29 - 100 PSI (2 - 7 BAR)
MAX. PARTICLE SIZE	1/8" (3 mm) or less	1/32" (1 mm) or less	1/32" (1 mm) or less
WETTED COMPONENTS	Aluminum & Hytrel	Aluminum & Hytrel	Polypropylene & Santoprene
DISCHARGE VOLUME PER CYCLE	Upto 600 ml	Upto 160 ml	Upto 190 ml
DIMENSIONS	10 × 10 × 12-3/8" (257 × 257 × 315 mm)	8-1/2 × 9-21/32 × 11-11/32" (216 × 245 × 288 mm)	8.5 × 8.5 × 11.34" (216 × 216 × 288 mm)
LIQUID TEMP.	0 - 80°C	0 - 80°C	0 - 60°C
MAX. AIR CONSUMPTION	900 LPM (31.8 CFM)	520 LPM (18.3 CFM)	700 LPM (24.7 CFM)
NOISE LEVEL	81 db	81 db	81 db
WEIGHT	9.3 kg (20 lbs)	5.4 kg (11.9 lbs)	2.54 Kg (5.6 lbs)
RECOMMENDED USE	Diesel fuel, Kerosene, Lubricants, Gear oil, Engine oil, Waste oil, Brake fluid, Naphtha, Mold lubricants, Antifreeze & Waste water	Diesel fuel, Kerosene, Lubricants, Gear oil, Engine oil, Waste oil, Brake fluid, Naphtha, Mold lubricants, Antifreeze & Waste water	Adblue, Antifreeze, Ethanol, Ammonium Hydroxide & Waste Water

ORDERING INFORMATION

CAT NR.	BOX QTY.
AODD/25/BAH/N	1
AODD/15/BAH/N	1
AODD/15/BPS/N	1



Designed for excellent mobility & simple to use pressurized evacuation - gravity draining of motor, engine, gearbox & differential oils

Durable all steel design & re-inforced castors

Centrally mounted 10 litre capacity bowl is height adjustable & can be optimally positioned allowing oil draining as well as other maintenance operations

68 litre tank includes a preset air regulator that allows the use of standard compressed air upto 150 PSI (10 BAR)

Tank includes a safety valve and a re-inforced dispensing hose that doubles as a sight gauge to prevent overfilling

Complete with a 14" (355 mm) telescopic bowl that can be adjusted from 45" (1143 mm) to 72" (1828 mm)

SPECIFICATIONS

TANK CAPACITY	68 Litres
MAX. COLLECTION CAPACITY	55 Litres
BOWL CAPACITY	10 Litres
BOWL INNER DIAMETER	14" (355 mm)
LENGTH OF DRAINING HOSE	2m
MAXIMUM HEIGHT	72" (1828 mm)
MINIMUM HEIGHT	45" (1143 mm)
RECOMMENDED DRAINING PRESSURE	8 PSI (0.5 BAR)

ORDERING INFORMATION

CAT NR.	BOX QTY.
WOD/68A	1



Bowl fitted with anti-splash screen



Dispensing hose doubles as a sight gauge to prevent over filling



Lockable front wheels provide stability to the unit



Used oil being drained from vehicle in an automotive workshop



WARNING

Do not use with fuels and corrosive media

195

Waste Oil Drain

WODP

Oil Drain with wheel mounted tank suitable for gravity draining of motor engine, gearbox & differential oils, transmission & power steering fluids etc. from motor vehicles

Heavy-duty polyethylene blow moulded tank with polyethylene injection moulded bowl & aluminium tube

30 Litres (8 Gallon) tank includes:

- Level indicator to monitor oil level and avoid oil spillage chances
- Deep & wide pockets with separation for small parts to store all type of tools while working
- Cap with rubber washer that prevents leakage while moving the drain

Centrally mounted 13 litres (3.4 Gallon) capacity bowl is height adjustable & can be optimally positioned for oil draining

Not for use with fuels and corrosive media

Supplied in CKD form

SPECIFICATIONS

TANK CAPACITY	30 Litres	8 Gallons
BOWL CAPACITY	13 Litres	3.4 Gallons
BOWL INNER DIAMETER	411 mm	16.2"
MAX. HEIGHT	1575 mm	62"
MIN. HEIGHT	1092 mm	43"

ORDERING INFORMATION

CAT NR.	BOX QTY.
WOD/P/8G	1

NEW!

Low height steel truck drain, designed for use with heavy duty commercial vehicles, buses & other low profile automobiles

Removable anti splash tray reduces splash & prevents particles larger than 0.20" (5 mm) dia. to enter into the tank

Suited to collect waste fluids - motor oils, transmission fluids, coolants etc.

Comes with 3" x 1" rubber wheels & front swivel castor for easy movement

Available in 2 sizes

- 68 litre capacity
- 90 litre capacity

Both sizes available in 2 Versions

- Gravity Oil Drain**
- Oil Drain with Manual Rotary Pump**
Manual rotary pump offers a discharge of upto 1 litre / 5 turns
- Oil Drain with Electric Pump**
 - Flexible Impeller design electric pump enables it to pump high viscosity fluid at high flow rate
 - Duty cycle: 45 min On / 45 min Off
 - UL approved motor
 - Motor has thermal overload protection to prevent over heating

WETTED COMPONENTS

Steel, PVC, ZAMAC*, Stainless Steel, NBR**

* Only in Truck Drain with Electric Pump Model

** Only in Truck Drain with Manual Pump & Electric Pump Models

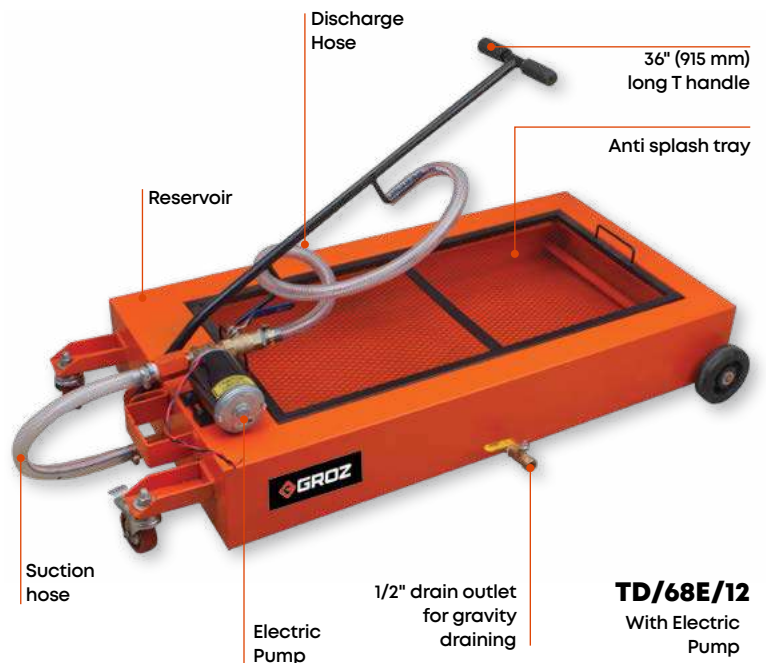

TD/68E/12
With Electric Pump



TD/68G
Gravity Oil Drain



TD/68P
With Manual Rotary Pump

ORDERING INFORMATION

CAT NR.	RESERVOIR CAPACITY	LENGTH		WIDTH		HEIGHT		PUMP FLOW RATE	COLOUR	BOX QTY.
	(LITRES)	(INCH)	(MM)	(INCH)	(MM)	(INCH)	(MM)			
GRAVITY OIL DRAIN										
TD/68G	68	41.92	1065	22	560	7-1/2	190	—	Orange	1
TD/90G	90	47.8	1215	29.5	750	8.3	212	—	Black	1
OIL DRAIN WITH MANUAL ROTARY PUMP										
TD/68P	68	41.92	1065	22	560	7-1/2	190	Upto 1 litre / 5 turns	Orange	1
TD/90P	90	47.8	1215	29.5	750	8.3	212		Black	1
OIL DRAIN WITH 220 V 50 HZ AC PUMP										
TD/68E/220/EU	68	41.92	1065	22	560	7-1/2	190	Upto 23 LPM	Orange	1
TD/90E/220/EU	90	47.8	1215	29.5	750	8.3	212		Orange	1
OIL DRAIN 12 V DC PUMP										
TD/68E/12	68	41.92	1065	22	560	7-1/2	190	Upto 17 LPM	Orange	1
TD/90E/12	90	47.8	1215	29.5	750	8.3	212		Orange	1

197

Plastic Truck Drain

TD-17

Truck drains eliminate the need to lift vehicles for changing oil or coolant

With a capacity of 65 litres & total height 7-3/4" (195mm) the reservoir is moulded from lightweight yet robust high impact polyethylene

Removable anti-splash screen prevents solid particles/debris of over 0.15" (3.8 mm) dia. from entering tank

Recessed pocket at each corner provides storage space for drain plugs & filters

Baffles inside the reservoir prevents any oil spillage during transport

Hose hanger for safe keeping the hose when not in use

4" (100 mm) nylon castors gives better manoeuvrability

Designed for use with heavy-duty trucks, buses, RV's & other low profile automobiles



Available in 3 Versions:

1. Gravity Oil Drain
2. Oil Drain with Manual Rotary Pump
3. Oil Drain with Electric Oil Pump:
 - Flexible Impeller design electric pump enables it to pump high viscosity fluid at high flow rate
 - Duty cycle: 45 On/45 min Off
 - UL approved motor
 - Motor has thermal overload protection to prevent over heating

WETTED COMPONENTS

Polyethylene, PVC, Steel, Cast Iron* , ZAMAC**, SS**, NBR***

* (Only for TD/17/P)

** (Only in TD/ 17/E)

*** (Only in TD/17P & TD/17E)

RECOMMENDED USE

Lubricating Oil (upto SAE 90), Non Corrosive Media, Waste Fluids including Motor Oil etc.

ORDERING INFORMATION

CAT. NR.	DESCRIPTION	PUMP FLOW RATE	BOX QTY.
TD/17G	Gravity Oil Drain	-	1
TD/17P	Oil Drain with manual rotary pump	Upto 1 litre / 5 turns	1
◆ TD/17E/220/EU	Oil Drain with 220V Electric Oil Pump	Upto 23 LPM	1
◆ TD/17E/12	Oil Drain with 12V Electric Oil Pump	Upto 17 LPM	1

◆ New



TD/17G
Gravity
Oil Drain



TD/17P
With Manual
Rotary Pump



198

Drain Pan

ODP-8

ODP-16

High Density Polyethylene Construction

Chemical / Solvent Resistant

Designed to ship in nested form

Available in 2 capacities

- 8 Litre
- 16 Litre

Large spout for fast pouring

Built-in anti splash lip & baffles

Includes large handle



NEW!

ODP-8
8 litres

ODP-16
16 litres

VARIANTS



Designed to ship in nested form

RECOMMENDED USE
WASTE OIL



RECOMMENDED USE
ANTIFREEZE/DEF



ORDERING INFORMATION

CAT NR.	CAPACITY (LITRE)	COLOUR	RECOMMENDED USE	BOX QTY.
◆ ODP/8	8	Black	Waste Oil	15
◆ ODP/8/GN	8	Green	Antifreeze/DEF	15
ODP/16	16	Black	Waste Oil	15
ODP/16/GN	16	Green	Antifreeze/DEF	15

◆ New



199

Heavy Duty High Flow Electric Fuel Pumps - Explosion Proof

FPM-HF

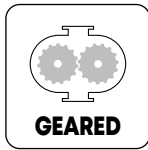
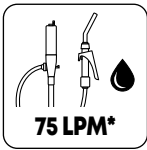

*Measured at pump outlet with vehicle engine switched on



Heavy duty industrial grade fuel pumps designed for heavy duty use in agriculture, construction, automotive & industrial applications

Rain & weather proof for tough outdoor use

Lightweight, yet strong non corroding aluminum die cast construction

Geared pump design using precision sintered metal gears

Geared construction makes the pump tolerant to contaminants in fuel, in addition to offering tremendous suction & minimal noise

UL & cUL listed motor

Duty Cycle: 30 minutes on / 30 minutes off

Select models available with meter & filter

WETTED COMPONENTS

Aluminium, Steel, Cast Iron, Nylon, NBR, Zinc, Viton, Stainless Steel

RECOMMENDED USE

Petrol, Diesel, E-15 Fuel, Kerosene, Bio Diesel

FLUIDS

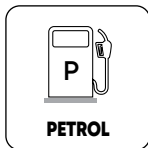
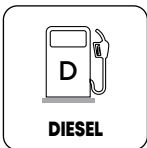

SPECIFICATIONS

DESCRIPTION	Heavy Duty 12V DC
EXPLOSION PROOF MOTOR	1/7 HP 12V DC
AMP	30 Amp
INTERNAL BYPASS VALVE	Yes
SUCTION PIPE	Steel
HOSE	1" x 12' anti static hose
TANK ADAPTER	2" threaded
INLET	1" NPT
OUTLET	1" NPT
DISPENSING NOZZLE	1" Manual with swivel
BATTERY CABLE (2 WIRES)	15'

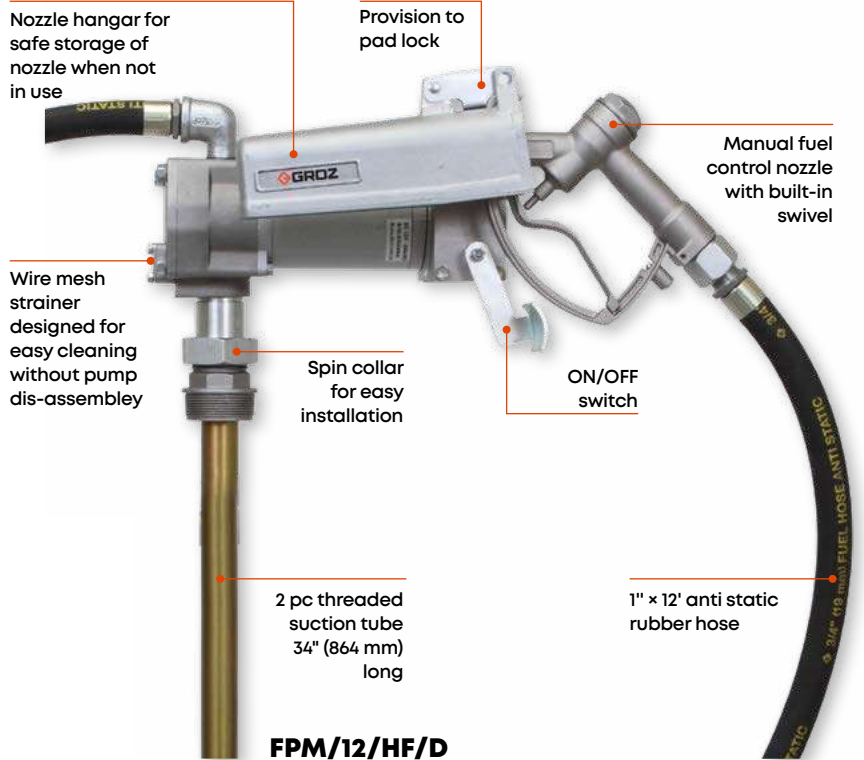

FPM/12/HF/D

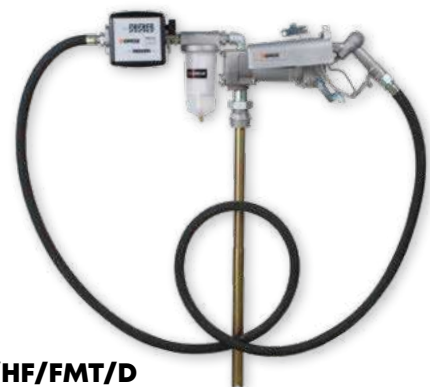

FPM/12/HF/FMT/D

ORDERING INFORMATION

CAT NR.	DESCRIPTION	BOX QTY.
FPM/12/HF/D	12V DC fuel pump complete with suction tube, bung nut, power cable, discharge hose & manual nozzle	1
FPM/12/HF/FMT/D	FPM/12/HF/D pump system along with mechanical fuel meter & fuel filter	1
SPARE PARTS & KITS		
ZSA/HOS/FPM/12/HF	Replacement Fuel Hose (Anti Static)	1



200

Heavy Duty Electric Fuel Pumps Explosion Proof

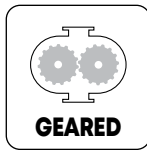
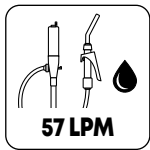

Heavy duty industrial grade fuel pumps designed for everyday use in agriculture, construction, automotive & industrial applications

Rain & weather proof for tough outdoor use

Lightweight, yet strong non corroding aluminum die cast construction

Geared pump design using precision sintered metal gears

Geared construction makes the pump tolerant to contaminants in fuel, in addition to offering tremendous suction & minimal noise

UL & cUL listed motor

Duty Cycle: 30 minutes on / 30 minutes off

Select models available with meter & filter

WETTED COMPONENTS

Aluminium, Steel, Cast Iron, Nylon, NBR Zinc, Viton, Steel Stainless

RECOMMENDED USE

Petrol , Diesel, E-15 Fuel, Kerosene, Bio Diesel

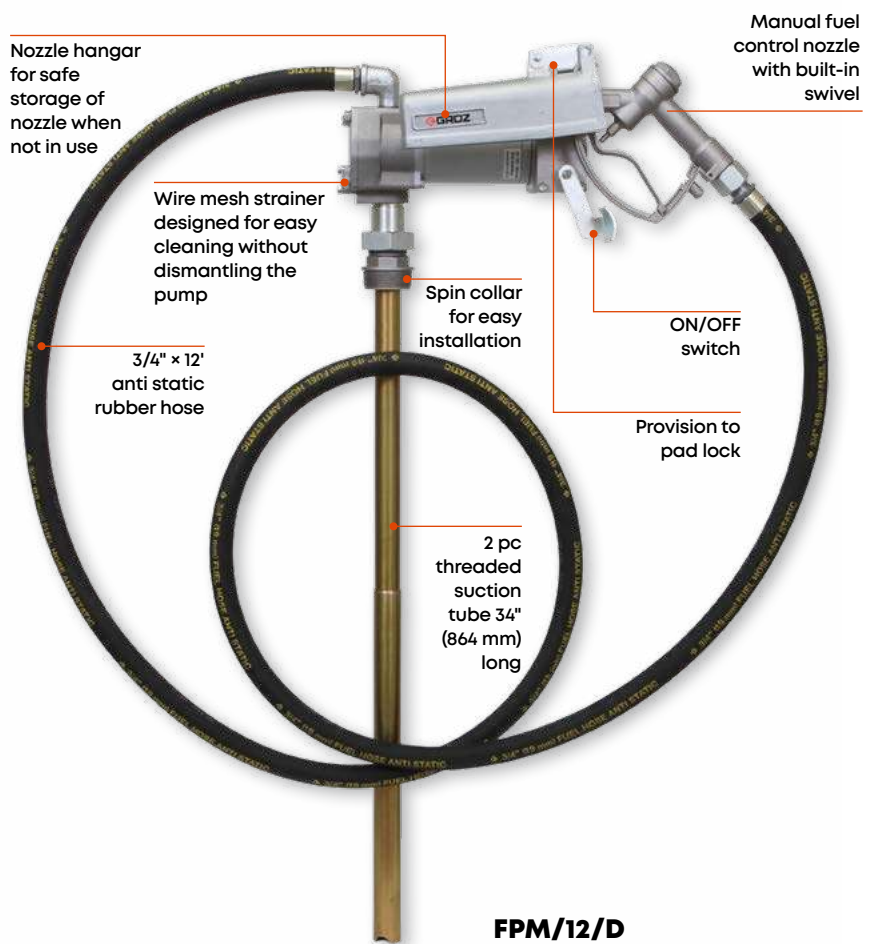

FPM/12/D

SPECIFICATIONS

	FPM-12	FPM-24
DESCRIPTION	HEAVY DUTY 12V DC	HEAVY DUTY 24V DC
FLOW RATE (AT PUMP OUTLET)	UPTO 57 LPM*	UPTO 57 LPM*
EXPLOSION PROOF MOTOR	1/7 HP 12V DC	1/7 HP 24V DC
AMP	25 AMP	11 AMP
INTERNAL BYPASS VALVE	YES	YES
SUCTION PIPE	STEEL	STEEL
HOSE	3/4" x 12' ANTI STATIC HOSE	3/4" x 12' ANTI STATIC HOSE
TANK ADAPTER	2" THREADED	2" THREADED
INLET	1" NPT	1" NPT
OUTLET	3/4" NPT	3/4" NPT
DISPENSING NOZZLE	3/4" MANUAL WITH SWIVEL	3/4" MANUAL WITH SWIVEL
BATTERY CABLE (2 WIRE)	15'	15'

* Measured at pump outlet with vehicle engine switched on

PUMP INTERNALS

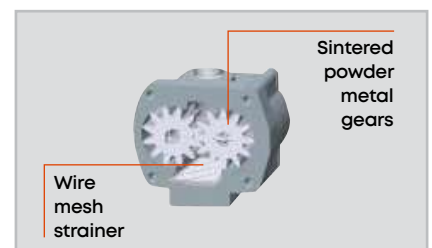

DRUM MOUNTING



FPM

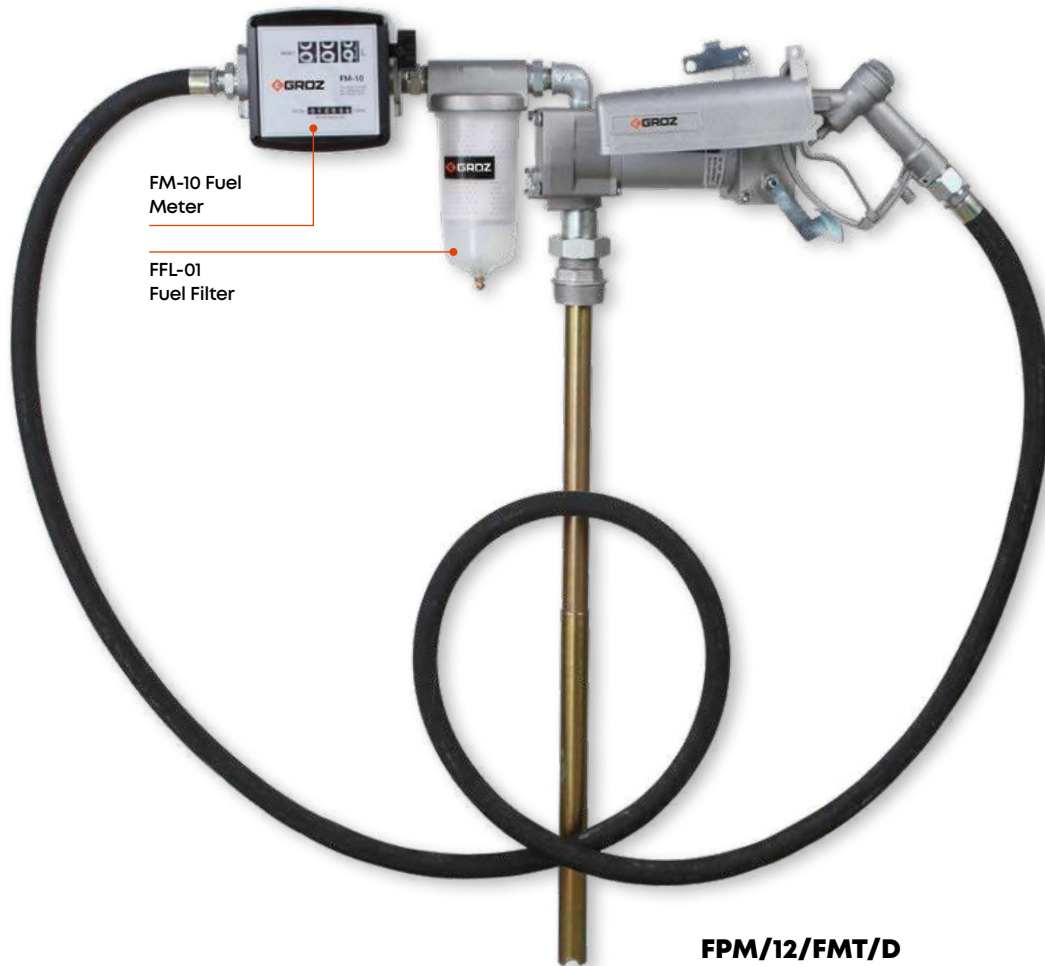

FPM/12/FMT/D

FLUIDS

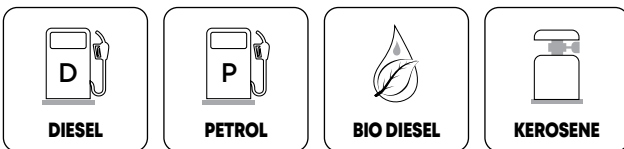

ORDERING INFORMATION

CAT NR.	DESCRIPTION	BOX QTY.
FPM/12/D	12V DC fuel pump complete with suction tube, bung nut, power cable, discharge hose & manual nozzle	1
FPM/24/D	24V DC Fuel Pump complete with suction tube, bung nut, power cable, discharge hose & manual nozzle	1
FPM/12/MT/D	FPM/12/D Pump System along with mechanical fuel meter	1
FPM/12/FMT/D	FPM/12/D Pump System along with mechanical fuel meter & fuel filter	1
◆ FPM/12/FMT/2000/D	FPM/12/D Pump System along with digital fuel meter & fuel filter	1
SPARE PARTS & KITS		
ZSA/HOS/FPM/12	Replacement Fuel Hose (Anti Static)	1

◆ New



201

Continuous Duty Electric Diesel Pump

CDP

CONTINUOUS DUTY

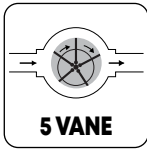
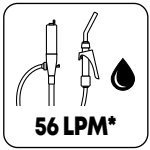

*Measured at pump outlet with vehicle engine switched on

Diesel Transfer Pump, ideal for use on stationary tanks, fixed fuel transferring systems & dispensers and other similar industrial applications

Lightweight, yet strong non corroding aluminium die cast construction

Self priming vane pump

Continuous Duty Cycle with thermal overload protection

WETTED COMPONENTS

Aluminium, Nitrile Rubber, Steel, Nylon

RECOMMENDED USE

Diesel & Kerosene

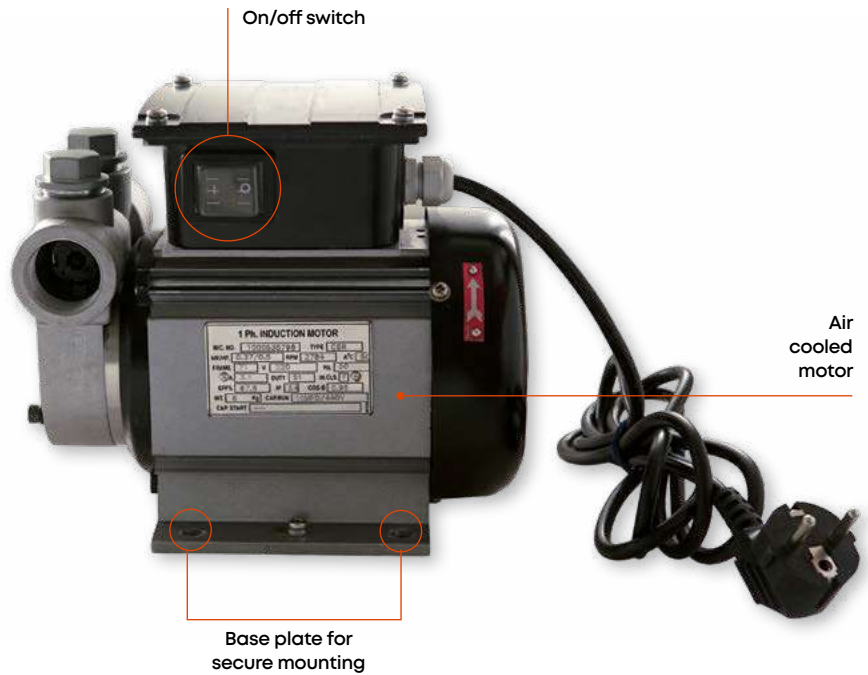

SPECIFICATIONS

DESCRIPTION	220V AC
MOTOR	1/2 HP 220V AC, 50/60 Hz
RPM	2700
INTERNAL BYPASS VALVE	Yes
INLET/ OUTLET	1" BSP (F)
POWER CABLE LENGTH	2m
DUTY CYCLE	Continuous Duty
HORIZONTAL DISTANCE DISCHARGE	50'
VERTICAL DISTANCE DISCHARGE	20'

FLUIDS

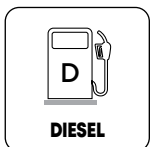

ORDERING INFORMATION

CAT NR.	INLET / OUTLET	BOX QTY.
CDP/220/EU	1" BSP	1

202 Electric Fuel Pump Continuous Duty - High Flow

CDP-HF

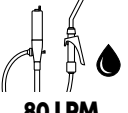

80 LPM



5 VANE



IP54

**CONTINUOUS
DUTY**

Continuous-duty diesel transfer pump

For use with stationary tanks, on-site fixed fuel transferring system, dispensers etc.

Self-priming vane pump with steel rotor & built-in by-pass valve, for ease of maintenance

Aluminium die-cast construction with IP 54 Protection

Duty Cycle
Continuous Duty

WETTED COMPONENTS
Cast Iron, NBR, POM

RECOMMENDED USE
Diesel & Kerosene



SPECIFICATIONS

FLOW RATE*	UPTO 80 LPM
MOTOR	3/4 Hp 220V AC
RPM	2800
INTERNAL BYPASS VALVE	Yes
INLET / OUTLET	1" BSPT (F)
POWER CABLE LENGTH	2M

*Measured at pump outlet

ORDERING INFORMATION

CAT NR.	INLET/OUTLET	BOX QTY.
CDP/220/80/EU	1" BSP (F)	1

FLUIDS



DIESEL



KEROSENE



203 Fuel Dispenser

FD-60

The **Fuel dispensing system** stands as an indispensable solution, revolutionizing the way fuel is distributed to vehicles and machinery. Engineered for efficiency, reliability, and convenience, this dispenser is the epitome of cutting-edge technology in the fueling industry. It provides **precise and repeatable volume readings during dispensing**

Includes:

1. **Auto Shut off nozzle** - built-in Sensor that automatically shuts off supply once fuel level in the tank reaches that of the outlet discharge spout
2. **Double walled cabinet** – Provides added strength, durability and an extended life span.
3. **LCD Display** - Indicates the discharge volume, total amount, and unit price.
4. **Receipt printer** – Provides a printed record of the dispensed amount, volume and date
5. **Pulse & Piston Meter** –The combination of pulse & piston meter ensures precise & accurate measurements in each dispense.
6. **Solenoid Valve** - Regulates the movement of fluid, either shut off or allow fluid flow.
7. **Filter** - screening out dirt and rust particles, preventing them from entering the pump and causing damage.



SPECIFICATIONS

FLOW RATE*	Upto 60 LPM
ACCURACY	± 0.3 %
POWER SUPPLY	12V DC
POWER	600W
DUTY CYCLE	30 min on/off
DISPLAY	Digital
NOZZLE	Automatic Shut Off Nozzles
INLET/OUTLET	1" BSP
FLOW METER	Piston Flow Meter
SUCTION HOSE	2m
DELIVERY HOSE	6m
DATA RECORD	Last 1000 fueling data
SUCTION HEAD	3m

*Measured at dispenser's outlet

ORDERING INFORMATION

CAT NR.	VOLTAGE	INLET	OUTLET	BOX QTY.
FD/60/12/D	12 V	1" BSP	1" BSP	1

DISCHARGE HEAD	15m
DATE & TIME SETTING	Yes
VOLUME	6 digits 0.00-9999.99L
AMOUNT	6 digits 0.00-9999.99
UNIT PRICE	4 digits 0.001-9999
SHIFT ACCUMULATIVE VOLUME	12 digits
DAILY ACCUMULATIVE VOLUME	10 digits
MONTH ACCUMULATIVE VOLUME	10 digits
ACCUMULATIVE TOTAL VOLUME	12 digits
DAILY ACCUMULATIVE VOLUME	10 digits
MONTH ACCUMULATIVE VOLUME	10 digits
ACCUMULATIVE TOTAL VOLUME	12 digits

204

Diesel Refilling System Mini Bowser

CBN

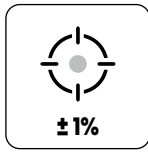
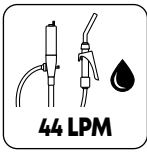

A compact & convenient system designed for all stationary diesel refilling applications

Extremely versatile, the bowser can be installed directly on a wall, on an existing structure with screws or directly on a tank

Complete system consists of:

a. Continuous Duty self-priming Diesel Pump

Self priming, vane pump with an internal bypass valve is equipped with a self ventilated, 1/2 HP motor with thermal overload protection. This makes it suitable for continuous usage

b. Mechanical Diesel Meter

Nutating disc mechanical meter flow rate of 20-120 LPM & pressure rating 145 PSI

c. Fuel Control Nozzle – Automatic

Dual mode nozzle - Manual & Automatic. Sensor in the discharge spout outlet automatically shuts off supply when fuel level in the tank reaches the discharge spout. The nozzle is equipped with a swivel at the inlet for convenience in usage

d. Fuel Hose

3.6m (10.5') x 1" (ID) long antistatic fuel hose

e. Nozzle Holder

In-built into the metal casing for keeping hose safe when not in use

f. Hose Hangar

For safe storage of nozzle

All encased in a sturdy weather-proof cabinet

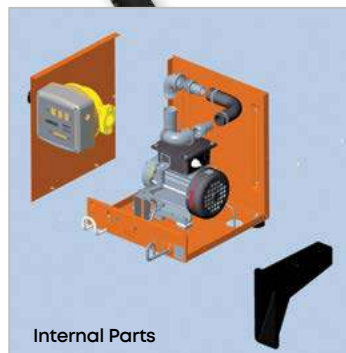
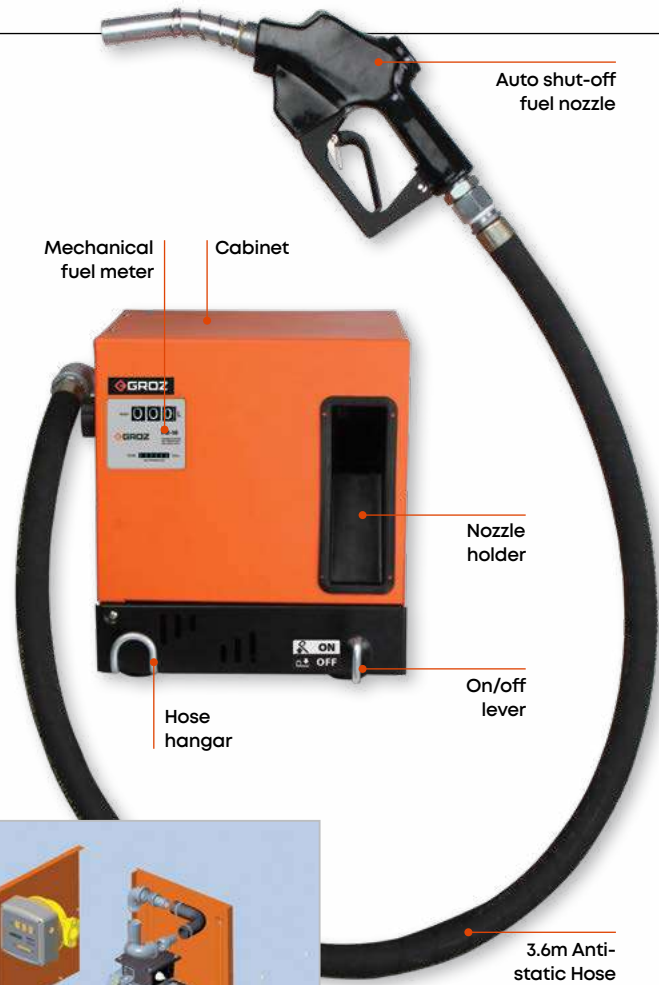

ORDERING INFORMATION

CAT NR.	BOX QTY.
CBN/220EU/L/A/D	1

FLUIDS

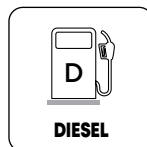

SPECIFICATIONS

SYSTEM / BOWSER DESCRIPTION	220V AC
INLET / OUTLET	1" BSP (F)
PUMP MOTOR	1/2 HP 220V AC, 50 Hz
PUMP RPM	2700
DUTY CYCLE	Continuous Duty
POWER CABLE LENGTH	2m
METER ACCURACY	± 1%
METER LEAST COUNT	0.10 litres
MAX. RESETTABLE BATCH TOTAL	999.9 litres
MAX. NON RESETTABLE TOTALIZER	999999 Litres



205 Open Bowser AC Diesel Refilling System OBN-AC

NEW!

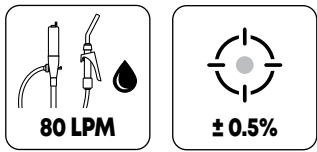

The Groz OBN-AC is a complete diesel dispensing system with a meter, pump

Easy to install, this station is designed to reliably pump and transfer diesel for stationary diesel refilling applications

In-built Fuel Nozzle Holder

Includes

- a. **AC Powered Continuous Duty Diesel Pump:** Self-priming, vane pump with an internal bypass valve
- b. **Mechanical Fuel Meter (FM-OV10)**
- c. **Fuel Control Nozzle – Automatic (FCNA-60)**
- d. **Fuel Hose:** 4m non-grounded discharge hose threaded 3/4"
- e. **Suction Hose:** 2m x 3/4" ID Braided transparent hose
- f. **Hardware:** Strainer, hose barb, hose clamp & swivel



WETTED COMPONENTS
Cast Iron, NBR, Aluminum, POM, PP

RECOMMENDED USE
Diesel & Kerosene

Duty Cycle
Continuous duty

SPECIFICATION

DESCRIPTION	220V	220V High Flow
FLOW RATE	Upto 60 LPM (16 GPM)	Upto 80 LPM (22 GPM)
INLET/ OUTLET	1"	1"
MOTOR	1/2 Hp 220V / 60 HZ	3/4 Hp 220V / 60 HZ
RPM	2800	2800
METER ACCURACY	±1%	±1%
METER LEAST COUNT	0.1 Litre	0.1 Litre
MAX. RESETTABLE BATCH TOTAL	9999.9 litres	9999.9 litres
MAX. NON RESETTABLE TOTALIZER	99999999 litres	99999999 litres
BATTERY CABLE	2m With EU plug	2m With EU plug
SUCTION HOSE	2m x 1" transparent braided hose	2m x 1" transparent braided hose
DISCHARGE HOSE	4m x 3/4" non-grounded hose	4m x 3/4" non-grounded hose

ORDERING INFORMATION

CAT NR.	FLOW RATE		BOX QTY.
	LPM	GPM	
OBN/60/220EU/L/A	60	16	1
OBN/80/220EU/L/A	80	22	1

FLUIDS

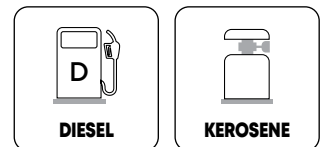

206

Electric Diesel Pumps - V Series

DP

NEW!

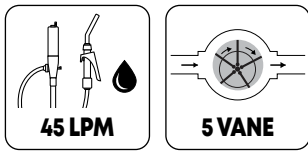

Portable diesel transfer pump

Designed for everyday use in agricultural, construction, automotive & industrial applications

Heavy Duty Cast iron Construction

Self-priming vane pump design

Bypass valve keeps the motor safe even when the outlet is closed

Duty Cycle

30 minutes ON /
30 minutes OFF

WETTED COMPONENTS

Cast Iron, NBR, PPS, Steel, Nylon

RECOMMENDED USE

Diesel, Kerosene

DO NOT USE WITH

Petrol (Gasoline) and solvents with flash point below 100°F (38°C)

FLUIDS

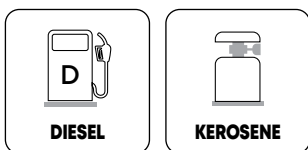

WARNING

Do not use fluids with a flash point below 100°F (38°C), such as Gasoline & Alcohol Sparking could result in explosion causing fatal injury



SPECIFICATIONS

DESCRIPTION	12V DC
FLOW RATE*	Upto 45 LPM (12GPM)
MOTOR	1/4 HP 12V DC
AMP DRAW FROM BATTERY	24 Amp
INTERNAL BYPASS VALVE	Yes
OUTLET	3/4" NPT(F)
BATTERY CABLE	2 meters with fuse & alligator clips

*Measured at pump outlet with vehicle engine switched on

ORDERING INFORMATION

CAT NR.	BASE PLATE	LIFT HANDLE	DRUM BUNG	NOZZLE TYPE	NOZZLE HOLDER	PUMP INLET THREADED	PUMP OUTLET THREADED	DISCHARGE HOSE	SUCTION TUBE	NYLON SUCTION STRAINER	BOX QTY.
DP/12	Yes	Yes	No	No	No	3/4" HB	3/4" HB	-	-	-	1
DP/12M/ST	Yes	Yes	No	Manual	No	3/4" HB	3/4" HB	Combo Hose 4m long		Yes	1
DP/12MD/ST	No	No	Yes	Manual	Yes	1"	3/4" HB	Hose 3 m long	2 pc Steel	No	1



207 Electric Diesel Pumps EDP

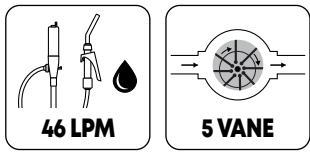

Portable diesel transfer pumps

Designed for everyday use in agricultural, construction, automotive & industrial applications

Lightweight, yet strong non-corroding aluminum die-cast construction

Self priming vane pump design

Bypass valve keeps the motor safe even when the outlet is closed

Duty Cycle

30 minutes ON /
30 minutes OFF

Pump Complete with

- Base plate and lift handle
- Manual Nozzle
- 4m x 3/4" (ID) hose that can be cut & used as suction & delivery hose
- Strainer
- 2m long battery cable with fuse & clamps
- Hardware - 3 hose barbs (3/4") & 4 hose clamps

WETTED COMPONENTS

Steel, Aluminum, Zinc, Nylon, NBR, PVC Nitrile, Acetal

RECOMMENDED USE

Diesel & Kerosene



SPECIFICATIONS

	12V DC	24 V DC
MOTOR	1/4 HP 12V DC	1/4 HP 24V DC
RPM	2600	2600
AMP	18 Amp	11 Amp
INTERNAL BYPASS VALVE	Yes	Yes
OUTLET	3/4" NPT	3/4" NPT
BATTERY CABLE (2 WIRE)	2m	2m

ORDERING INFORMATION

CAT NR.	DESCRIPTION	BOX QTY.
EDP/12M/ST	12V DC	1
EDP/24M/ST	24V DC	1

FLUIDS

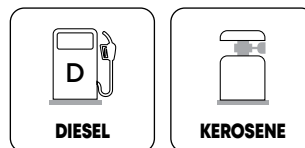

WARNING

Do not use with flash point below 38°C such as Petrol or Alcohol. Sparking could result in explosion causing fatal injury

208

**Electric Diesel Pump
Heavy Duty**

EDP-HD

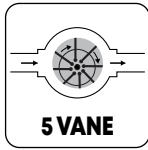
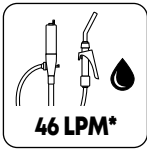

24V DC portable Heavy Duty Diesel Transfer Pump

Designed for heavy usage in agricultural, construction, automotive and industrial applications

Lightweight & non-corroding Aluminium die cast construction

Self-Priming Vane pump design

Vanes made from steel for high tensile strength

Air Cooled Motor

Fuse position in secure electric box for increased safety

Compact Bracket Mounting design for use in confined spaces

Pump complete with

- Base plate and lift handle
- 4m x 3/4" (ID) hose that can be cut & used as suction & delivery hose
- Nylon suction strainer
- Battery cable 2m with fuse & clamps
- Manual nozzle
- Hardware - 3 hose barbs (3/4") & 4 hose clamps

Duty Cycle

45 minutes ON /
45 minutes OFF

WETTED COMPONENTS

Steel, Aluminium, Zinc, Nylon, Rubber & PVC Nitrile

RECOMMENDED USE

Diesel & Kerosene



Designed for use in extreme heat without loss in performance

SPECIFICATIONS

MOTOR	1/4 HP 24V DC
POWER	180 Watts
RPM	2400
CURRENT DRAWN	12 Amp
INTERNAL BYPASS VALVE	Yes
INLET	3/4" NPT
OUTLET	3/4" NPT
BATTERY CABLE	2m

* Measured at pump outlet with vehicle engine switched on

ORDERING INFORMATION

CAT NR.	BOX QTY.
EDP/HD/24M/ST	4

FLUIDS

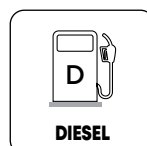

WARNING

Do not use fluids with a flash point below 100°F (38°C), such as Gasoline or Alcohol. Sparking could result in explosion causing fatal injury



209 Industrial Rotary Drum Pumps RBP-3V

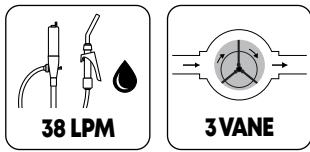

Industry standard for rotary pumps, these are by far the heaviest duty pumps, ideal for tough outdoor use in extreme weather conditions. Suitable for transferring media into smaller container or for quick refuelling of diesel powered vehicles or equipment

Deliver media with a head / lift upto 20' (6 metres)

Solid cast iron construction, fully CNC machined to close tolerances

Pump handle rotates a high quality sintered powder metal 3 vane rotor inside a highly finished pumping chamber

Graphite vanes are self lubricating & non wearing

High quality graphite seal allows the pump to be used with a wide variety of fluids

Self priming operation with discharge up to 38 LPM

For use with 50-210 litre barrels

WETTED COMPONENTS

Cast Iron, Steel, Graphite, Paper, Polypropylene

RECOMMENDED USE

Petroleum based fluids, Diesel, Petrol & Kerosene

DO NOT USE WITH

Water Based Media

FLUIDS



ORDERING INFORMATION

CAT NR.	DETAILS	BOX QTY.
RBP/3V	Pump with steel discharge spout	1
RBP/3V/H	Pump with 8' anti static hose, nozzle & nozzle holder	1

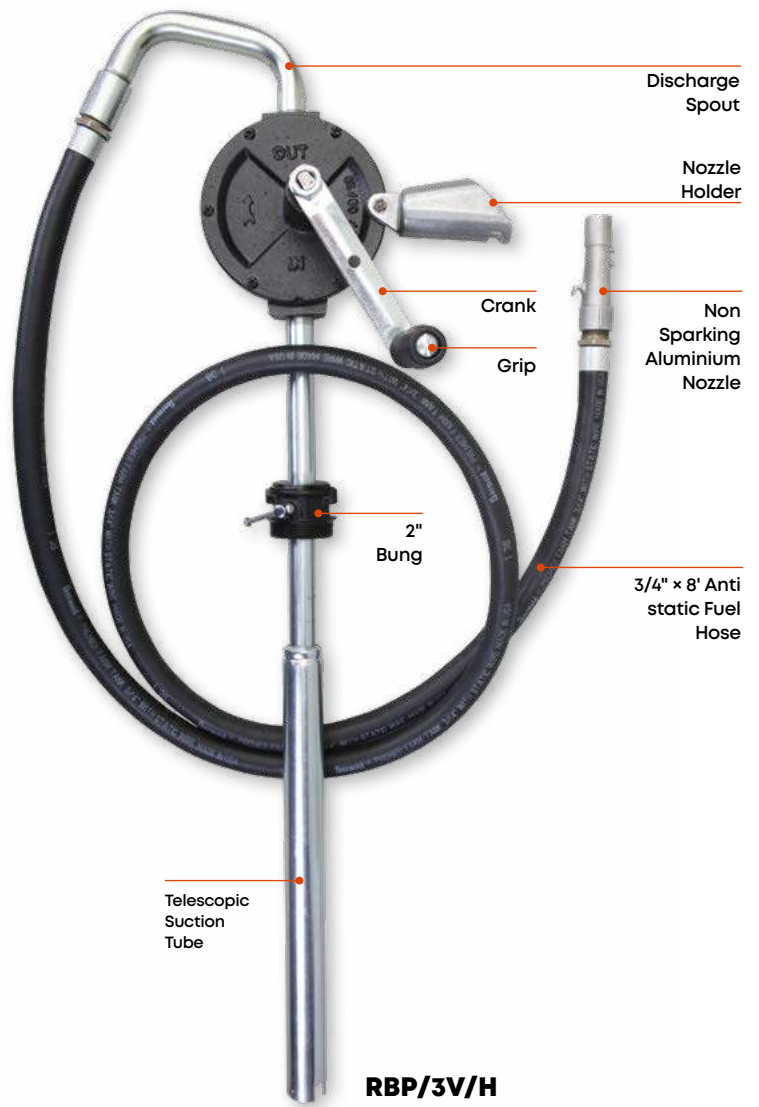

RBP/3V/H

RBP/3V



210

Rotary Booster Pump 3:1

RB-3

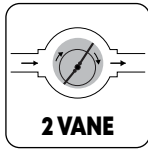

Geared rotary drum pump with 3 times discharge per rotation

For every complete handle turn, the rotor turns 3 times

Ideal for volume dispensing, such as on construction sites, workshop, aviation, farms / ranches, boats etc.

Die Cast Aluminum construction with sintered gear driven die cast zinc rotor & vanes

Complete with 3 pc threaded suction tube for use on 50-205 litre drums

WETTED COMPONENTS

Aluminum, Zinc, Steel, NBR & PVC Nitrile

RECOMMENDED USE

Petrol, Diesel & Kerosene

DO NOT USE WITH

With Corrosive liquids, solvents, acids, alkalis etc.



3
MINUTES
Empties
210L reservoir

PUMP INTERNALS

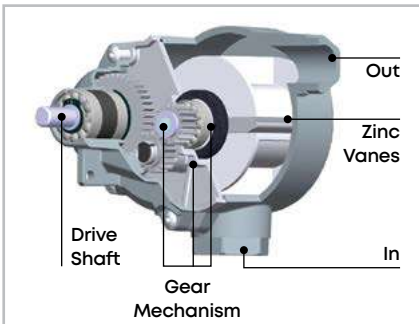

ORDERING INFORMATION

CAT NR.	BOX QTY.
RB/3H	1

FLUIDS

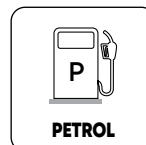
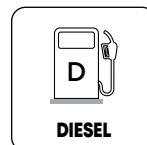

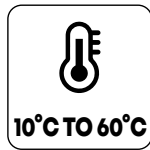
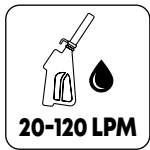

High accuracy flow meter with mechanical register

Nutating disc mechanism offers high tolerance to contaminated fuels

Meter is designed for both In-Line applications & gravity flow (with a minimum gravity head of 4')

Ideal for use with electric fuel pumps

Register cap can be easily removed & rotated to every 90° orientation for convenient read out

Robust aluminium die cast construction

Easy user re calibration

WETTED COMPONENTS

Aluminium, Buthyl Terephthalate, Nitrile Rubber

RECOMMENDED USE

Diesel, Biodiesel, Oils

DO NOT USE WITH

Petrol, Water based media



Display can be changed by rotating the card in its housing thus ensuring greater versatility in positioning

SPECIFICATIONS

ACCURACY*	± 1%
REPEATABILITY*	± 0.30%
LEAST COUNT /RESOLUTION	0.10 Litres or 0.10 Gallons
BURST PRESSURE	435 PSI (30 BAR)
PRESSURE LOSS	3 PSI (0.20 BAR)
MAX. RESETTABLE BATCH TOTALIZER	999.9 Litres or 99.9 Gallons
MAX. NON RESETTABLE BATCH TOTALIZER	9,99,999 Litres or 99999.9 Gallons
MAX. VISCOSITY OF MEDIA	2000 cst

* Tested in laboratory conditions

Note: Not to be used to measure media for resale

ORDERING INFORMATION

CAT NR.	THREADS	BOX QTY.
FM/10/0-1/BSP	1" BSP (F)	1

FLUIDS

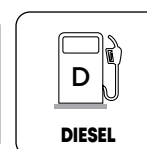

212

Mechanical Fuel Meter Oval Gear

FM-OV10

NEW!

High accuracy Fuel meter with mechanical register

Oval gear mechanism offers high tolerance to fuel contamination

Robust aluminium die cast construction

Meter is designed for in-line applications, Ideal for use with electric fuel pumps

Easy user re-calibration

WETTED COMPONENTS

Aluminium, NBR, PP

DO NOT USE WITH

Water based media

RECOMMENDED USE

Diesel, Bio-diesel, Low to Medium Viscosity Oils



SPECIFICATION

ACCURACY	±1%
FLOW RATE	Upto 120 LPM (32 GPM)
REPEATABILITY	±0.3%
MAX. VISCOSITY	1000 cps
MAX. PRESSURE	220 PSI (15 Bar)
MAX. RESETTABLE BATCH TOTAL	9999.9 Litre
MAX. NON-RESETTABLE BATCH TOTALIZER	99999999 Litre
LEAST COUNT	0.1 Litre
INLET/OUTLET	1" BSP (F) / 1" NPT (F)

ORDERING INFORMATION

CAT NR.	MEASURES IN	THREADS	BOX QTY.
FM/OV-10/BSP	Litre	1" BSP	1

FLUIDS

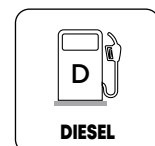

NEW!

Heavy-duty high-accuracy flow meter with mechanical register

Robust aluminium die cast construction

Oval gear mechanism Meter is designed for both in-line applications & gravity flow

Flexibility of installation options; can be mounted horizontally or vertically; no flow conditioning required

Meter construction enables fast and easy on-site servicing without removal from the application

WETTED COMPONENTS

Aluminium, NBR, Graphite

DO NOT USE WITH

Water based media

RECOMMENDED USE

Gasoline, Diesel, Kerosene, Fuel oils

SPECIFICATION

ACCURACY	±1%
FLOW RATE	Upto 120 LPM (32 GPM)
REPEATABILITY	±0.3%
MAX. VISCOSITY	1000 CPS
MAX. PRESSURE	220 PSI (15 Bar)
MAX. RESETTABLE BATCH TOTAL	9999 litre
MAX. NON-RESETTABLE BATCH TOTALIZER	9999999
LEAST COUNT	1 Liter
INLET/OUTLET	1" BSP (F) / 1" NPT (F)

ORDERING INFORMATION

CAT NR.	ORD NR.	MEASURES IN	THREADS	BOX QTY.
MFM/M10/BSP	45601	Litre	1" BSP	1

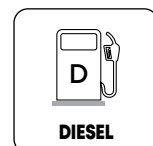
FLUIDS

214

Digital Oval Gear Fuel Meter

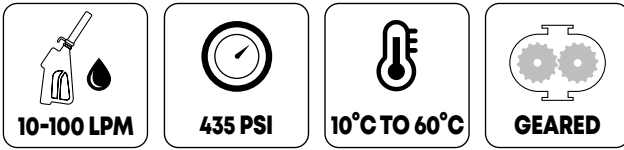
FM-25

Heavy duty, high accuracy electronic fuel meter

Electronic display using 2 × 1.5V alkaline battery

Oval gear mechanism that provides high accuracy over a wide range of fluids with reduced loss of head

Aluminium body with built in suction filter

Measures in litres, quarts, pints & gallons

Easy user recalibration

RECOMMENDED USE

Diesel

DO NOT USE WITH

Water based media, Acids etc

WETTED COMPONENTS

Polyoxymethylene, Aluminium, Steel, Neodymium



SPECIFICATIONS

ACCURACY	± 0.5%
REPEATABILITY	± 0.2%
MAX WORKING PRESSURE	435 PSI (30 BAR)
PARTIAL TOTAL	0.001 to 99999 units
MAX RESETTABLE TOTAL	9,99,99 (5 digits with × 100 indicator) units
MAX NON-RESETTABLE TOTAL	9, 99,99,999 (8 digits with × 100 indicator) units
LEAST COUNT/ RESOLUTION	Upto 0.001 units
VISCOSITY	Upto upto 2000 cst

ORDERING INFORMATION

CAT NR.	INLET / OUTLET	BOX QTY.
FM/25/3-4/BSP	3/4" BSP (F)	1
FM/25/0-1/BSP	1" BSP (F)	1

FLUIDS

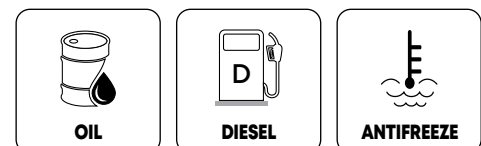

NEW!

Heavy-duty high-accuracy flow meter with Electronic register

Robust aluminium die cast construction

Oval gear mechanism Meter is designed for both in-line applications & gravity flow

Flexibility of installation options (e.g. can be mounted horizontally or vertically; no flow conditioning required)

Meter construction enables fast and easy on-site servicing without removal from the application

WETTED COMPONENTS

Aluminium, NBR, Graphite

DO NOT USE WITH

Water based media

RECOMMENDED USE

Gasoline, Diesel, Kerosene, Fuel oils



SPECIFICATION

ACCURACY	±0.5%
FLOW RATE	Upto 120 LPM (32 GPM)
REPEATABILITY	±0.2%
MAX. VISCOSITY	1000 CPS
MAX. PRESSURE	220 PSI (15 Bar)
UNITS	M ³ , Litres, Gallons, US Gallons, KG
MAX. RESETTABLE BATCH TOTAL	9999999
MAX. NON-RESETTABLE BATCH TOTALIZER	9999999
LEAST COUNT	0.001 Litre / Gallon
INLET/OUTLET	1" BSP (F)

ORDERING INFORMATION

CAT NR.	THREADS	BOX QTY.
MFM/D10/BSP	1" BSP	20

FLUIDS

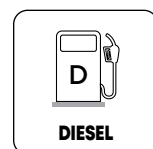

216

Digital Fuel Meter Professional

FM-2000



Digital Turbine meter for low viscosity fluids, easy to install in line or for end of the line applications

Polyamide Turbine measuring mechanism

Electronic Display using one 3.7V Li-ion battery (CR2450)

Aluminium body and sealed electronic card make it suitable for use in severe weather conditions

Display can be rotated in 4 different positions

Bi-Directional

Either ports can be used as Inlet / Outlet

Measures in Litres, Quarts, Pints & Gallons

Easy user re calibration

WETTED COMPONENTS

Aluminum, Polyamide & Stainless Steel

RECOMMENDED USE

Diesel, Petrol, Bio Diesel

DO NOT USE WITH

Oils

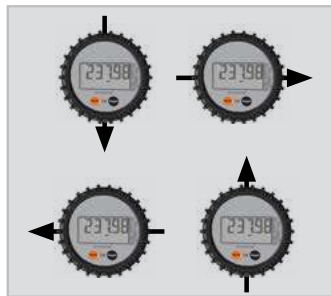

Display can be changed by rotating the card in its housing thus ensuring great versatility in positioning

FLUIDS



ORDERING INFORMATION

CAT NR.	THREADS	BOX QTY.
FM/2000/0-1/BSP	1" BSP (F) x 1" BSP (F)	20

SPECIFICATIONS

FLOW RATE	4-120 LPM	1-30 GPM
ACCURACY*	± 1%	
REPEATABILITY*	± 0.25%	
MAX WORKING PRESSURE*	150 PSI	10 BAR
WORKING TEMPERATURE RANGE	-4°F TO 158°F	-20°C TO 70°C
WATER RESISTANCE	IP55	
UNITS OF MEASURE	Pints, Quarts, Liters, Gallons	
PARTIAL TOTAL	0.001 to 99999 units	
MAX RESETTABLE TOTAL	9,99,999 units (6 digits with × 100 indicator)	
MAX NON-RESETTABLE TOTAL	9,99,999 units (6 digits with × 100 indicator)	
LEAST COUNT/ RESOLUTION	UPTO 0.001 units	
VISCOSITY	UPTO 5.35 cst	

* Tested in laboratory conditions

Note: Not to be used to measure media for resale



217

Fuel Control Nozzles Manual

FCN

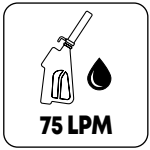

For use with manual & electric fuel pumps

All metal construction with the body, discharge spout, trigger & guard made from aluminium

Hose swivel at inlet offers increased maneuverability & convenience in use

Manual control; also includes continuous flow switch for unattended dispensing

Designed for minimal back pressure & reduction in flow

WETTED COMPONENTS

Aluminum, Steel, Nylon, Nitrile Rubber

FLUIDS

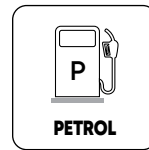
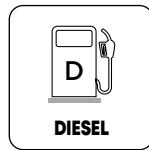

ORDERING INFORMATION

CAT NR.	INLET THREAD	SPOUT OUTER DIA.	MAX. FLOW RATE	RECOMMENDED USE	BOX QTY.
		(MM)	(LPM)		
FCN/S/3-4/3-4/N	3/4" NPT (F)	19	57	Diesel & Petrol	1
FCN/S/0-1/0-1/N	1" NPT (F)	25	75	Diesel	1

218

Fuel Control Nozzles Automatic

FCNA



For use with Electric Fuel Pumps

Dual Mode: Manual & Automatic. Sensor built into the discharge spout outlet automatically shuts off supply once fuel level in the tank reaches that of the outlet discharge spout

Heavy-duty cast aluminum body, trigger & guard from thermoplastic & protective vinyl grip on the nozzle body

WETTED COMPONENTS

Aluminium, Viton

FLUIDS

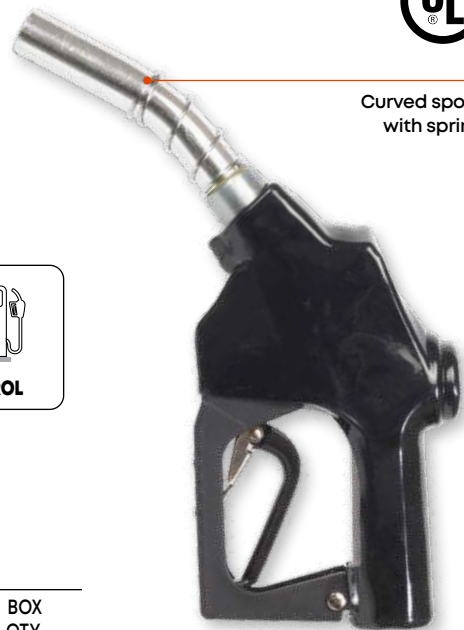
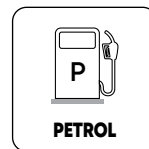
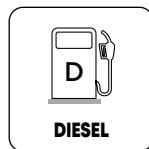

Curved spout with spring

ORDERING INFORMATION

CAT NR.	RECOMMENDED USE	INLET THREAD	SPOUT OUTER DIA.	MAX. FLOW RATE	BOX QTY.
			(MM)	(LPM)	
FCNA/3-4A/N	Diesel & Petrol	3/4" NPT (F)	21	60	1
FCNA/0-1/N	Diesel	1" NPT (F)	27	100	1

219

Fuel Control Nozzles Automatic V Series

FCNA-E

For use with electric fuel pumps

Dual Mode - Manual & Automatic Sensor built into the discharge spout outlet automatically shuts off supply once fuel level in the tank reaches that of the outlet discharge spout

Heavy duty cast aluminum body, trigger & guard from thermoplastic & protective vinyl grip on the nozzle body

WETTED COMPONENTS

Aluminium, Viton

RECOMMENDED USE

Diesel & Kerosene

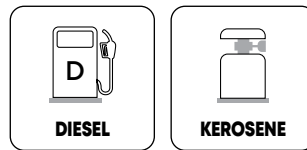
FLUIDS

NEW!
ORDERING INFORMATION

CAT NR.	INLET THREADS	SPOUT DIA (OD)		SPOUT DIA (ID)		FLOW RATE		SPOUT LENGTH		BOX QTY.
		(INCH)	(MM)	(INCH)	(MM)	LPM	GPM	(INCH)	(MM)	
FCNA/60/3-4B/BSP	3/4" BSP	15/16	24	-	19	60	16	6-11/16	170	1
FCNA/120/0-1T/BSP	1" BSP	1-1/8	29	-	25	120	32	6-11/16	170	1

220

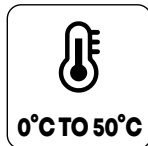
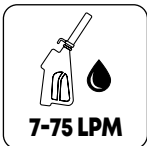
Fuel Control Nozzle Metered

FM20-FCN

Manual Fuel Control Nozzle fitted with Digital Fuel Meter

Die cast aluminium nozzle with built-in swivel, aluminium meter body and sealed electronic card suitable for rugged use

Measures in litres, quarts, pints & gallons

WETTED COMPONENTS

Polyamide, Aluminum, Steel, Nylon, Nitrile Rubber

SPECIFICATIONS

ACCURACY	± 1%
REPEATABILITY	± 0.30 %
MAX. WORKING PRESSURE	50 PSI (3.45 BAR)
MAX. RESETTABLE BATCH TOTALIZER	99,999 Litres
MAX. NON RESETTABLE BATCH TOTALIZER	9,99,999 Litres
LEAST COUNT/ RESOLUTION	0.001 Units
MAX. VISCOSITY OF MEDIA	5.35 cst

ORDERING INFORMATION

CAT NR.	INLET THREAD	SPOUT OUTER DIA.	BOX QTY.
		(MM)	
FM/20/FCN/3-4/N	3/4" NPT (F)	19	1
FM/20/FCN/0-1/N	1" NPT (F)	25	1

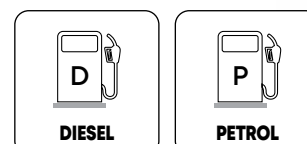
FLUIDS

IP55

221

Dual Plane Fuel Nozzle Swivels

SWV-2P



Swivels are installed between fuel nozzle & hose to reduce strain, provide flexibility & long life to hose

Provide 360° rotation for free movement facilitating flexibility to refuel vehicles from any direction

Aluminium die cast construction with male threaded end made from brass

Laminar flow design for higher fuel flow

Dual 'O' ring seal for long service life

Compatible with fuels containing alcohol

WETTED COMPONENTS

Aluminium, Brass, Viton

RECOMMENDED USE

Diesel, Kerosene, Petrol, Bio-Diesel

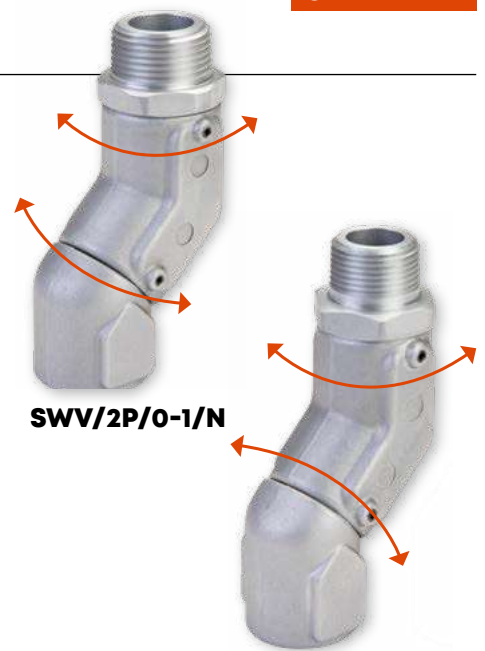

SWV/2P/0-1/N

SWV/2P/3-4/N

ORDERING INFORMATION

CAT NR.	THREADS	BOX QTY.
SWV/2P/3-4/N	3/4" NPT (F) × 3/4" NPT (M)	1
SWV/2P/0-1/N	1" NPT (F) × 1" NPT (M)	1

FLUIDS

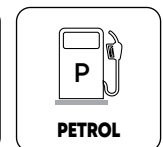
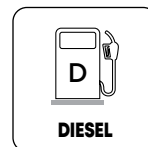

222

Fuel Dispensing Kits

FDK

Gravity feed fuel dispensing kit comprising of 3m rubber hose fitted with manual fuel control nozzle with swivel

Hose also available as spare
Hose Length: 3.6m complete with end connections



Fuel Dispensing Kit

ORDERING INFORMATION

CAT NR.	HOSE INNER DIAMETER	HOSE LENGTH	THREADS	SUITABLE FOR PUMP	BOX QTY.
FUEL DISPENSING KIT					
FDK/3/3-4/N	3/4"	3 m	3/4" NPT (M)	FPM-12	1
FDK/3/0-1/N	1"	3 m	1" NPT (M)	FPM/12/HF	1
SPARE HOSE					
ZSA/HOS/FPM/12	3/4"	12'	3/4" NPT (M)	FPM-12	1
ZSA/HOS/FPM/12/HF	1"	12'	1" NPT (M)	FPM/12/HF	1



Spare Hose

223

Filter Wrench

FW-FFL

Easy to use wrench for removing filter bowl when changing filter element

Weather resistant reinforced nylon construction ensures no damage to filter bowl

Specially designed to fit GROZ FFL-02 fuel filter bowl

Wire through hole provided for attaching to fuel tank

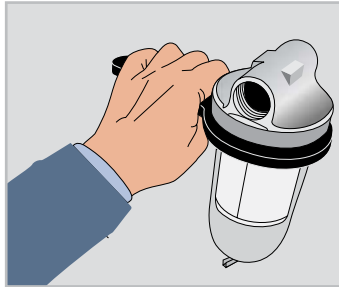

Fits fuel filter bowl for easy removal without cracking!



Wire through hole

ORDERING INFORMATION

CAT NR.	BOX QTY.
FW/FFL-02	10

224

Portable Fuel Filter

FUF

Designed to filter out water, contaminants & debris from various fuels & light oils

Anti-static, portable design with built in vertical filter to separate contaminants & water from fuel

Vertical design of the filter permits free flow of fluids without exerting any pressure on the filter screen

Filters out water & solids till 100 microns

Rugged Polypropylene body with Carbon as an additive makes the unit light weight & resistant to dents & scratches

WETTED COMPONENTS

Stainless Steel, Teflon, Polypropylene

RECOMMENDED USE

Diesel, Kerosene, Gasoline, Light oils

DO NOT USE WITH

Detergents, Non Compatible media

NEW!

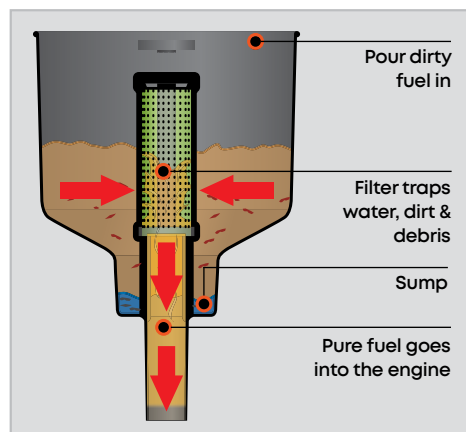

ORDERING INFORMATION

CAT NR.	BOX QTY.
FUF-13	20

SPECIFICATIONS

FLOW RATE	UPTO 13 LPM
-----------	-------------



225

Fuel Filter

FFL-01



150 PSI

Isoplast see-through bowl with aluminium head and 10 micron filter element

Suitable for use with manual or electric fuel pumps

Filters small particles of rust, scale, grit, dirt and sand

Replacement filter element available as spare

Suitable for use with different fuels in Agricultural & Industrial applications

Water block filter element used to separate water from fuel

WETTED COMPONENTS

Aluminium, Isoplast, NBR, Steel, Paper element, Nylons

RECOMMENDED USE

Diesel & Petrol, Fuel Oil, Ethyl and Isopropyl Alcohol

DO NOT USE

Gasohol, Aviation Fuels, Race Fuels, water based products

FLUIDS

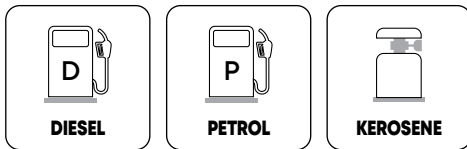

Aluminium die cast filter head - threaded 1" at inlet & outlet

Filter element

Isoplast See-through bowl

Brass Drain Cock - releases accumulated water & contaminants by a simple turn

FFL-01/B

FF/FFL/10
Replacement Filter Element



ORDERING INFORMATION

CAT NR.	FILTER ELEMENT	THREADS	BOX QTY.
FFL-01/B	10 µ	Fuel Filter. Threaded 1" BSP (F)	10
FFL/01/3-4/N	10 µ	Fuel Filter. Threaded 3/4" BSP (F)	10
REPLACEMENT FILTER ELEMENT			
FF/FFL/10-ST	10 µ	Fuel Filter Element	10
FF/FFL/10-WB/ST	10 µ	Water Block Fuel Filter Element	10
REPAIR PARTS			
ZSA/CON/FFL/01	Replacement Filter Bowl with Drain Valve		10

226

Fuel Filters Spin - On Cartridge Style

FFS-10



High Flow Fuel Filter, complete with 10 micron spin-on style filter cartridge

Aluminum Die Cast Head, vacuum impregnated for leak proof operation

Inlet & Outlet threaded
1" BSP (F)

Fits spin on cartridges with 1-1/2"-16 UNF threads

Designed for use on both mobile & stationary fuel tanks and on petrol & diesel fuel pumps

Ideal for use in construction & agricultural applications

Removes particulate contaminants such as dirt, dust & rust

Replacement Spin-On Filter cartridges available as spare

RECOMMENDED USE

Petrol, Diesel

DO NOT USE WITH

Water Based Products, Aviation, Fuels, Race Fuels etc.

FLUIDS

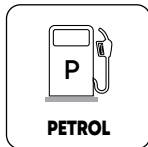
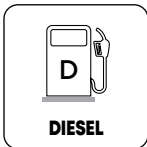

ORDERING INFORMATION

CAT NR.	FILTER ELEMENT	INLET / OUTLET	BOX QTY.
FFS/10/BSP	10µ filter	1" BSP (F)	10
FFS/10WB/BSP	10µ water block filter	1" BSP (F)	10
REPLACEMENT CARTRIDGE			
FF/FFS/10	10µ filter		10
FF/FFS/10-WB	10µ water block filter		10



FFS/10/BSP

FF/FFS/10



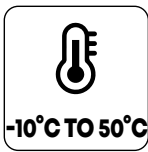
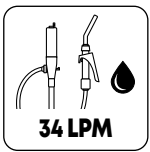

Diaphragm transfer pump designed for dispensing DEF

Lightweight non corroding, weather proof polypropylene body

Self priming pump design

Built-In Thermal Overload Protection

Duty Cycle

30 minutes ON /

30 minutes OFF

Pump inlet & outlet fitted with 3/4" (19 mm) hose barbs

WETTED COMPONENTS

Polypropylene, EPDM, Viton

RECOMMENDED USE

DEF, Urea, Water, Antifreeze, Detergents etc.

DO NOT USE WITH

Diesel, Kerosene, Gasoline, Oils etc.



SPECIFICATIONS

	DEFP/12	DEFP/220
INPUT VOLTAGE	12V DC	220V AC, 50/60 Hz.
MOTOR HP	1/4 HP	1/2 HP
RPM	2900	2800
AMP	16 Amp	1.5 Amp
INLET / OUTLET	3/4" Hose Barb	3/4" Hose Barb
POWER CORD / CABLE	2m long with alligator clamps	2m long with Plug

ORDERING INFORMATION

CAT NR.	DESCRIPTION	BOX QTY.
* DEFP/12	12V DC	4
* DEFP/220	220V AC, 50 Hz.	4

* Best Seller

FLUIDS

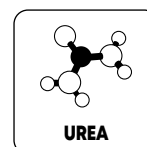
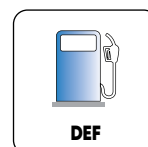
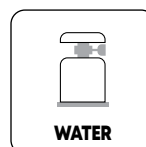

228

DEF Dispenser

AD-40

A **DEF dispensing system** is a crucial component in the world of modern diesel engines

These systems ensure efficient and accurate distribution of AdBlue to vehicles and machinery

It provides **precise and repeatable volume readings** during dispensing

Includes:

- 1. SS Auto Shut off nozzle** - built-in Sensor that automatically shuts off supply once fuel level in the tank reaches that of the outlet discharge spout
- 2. Double walled cabinet** - Provides added strength, durability and an extended life span.
- 3. LCD Display** - Indicates the discharge volume, total amount, and unit price.
- 4. Receipt printer** - Provides a printed record of the dispensed amount, volume and date
- 5. Pulse & Piston Meter** -The combination of pulse & piston meter ensures precise & accurate measurements in each dispense.
- 6. Solenoid Valve** - Regulates the movement of fluid, either shut off or allow fluid flow.
- 7. Filter** - screening out dirt and rust particles, preventing them from entering the pump and causing damage.



SPECIFICATIONS

FLOW RATE*	Upto 40 LPM
ACCURACY	± 0.3 %
POWER SUPPLY	220V AC
POWER	550W
DUTY CYCLE	Continuous
DISPLAY	Digital
NOZZLE	Automatic shut off nozzles
INLET	1" BSP
OUTLET	3/4" Hose barb
FLOW METER	Piston meter
SUCTION HOSE	2m
DELIVERY HOSE	6m

*Measured at dispenser's outlet

SUCTION HEAD	9m
DISCHARGE HEAD	15m
DATA RECORD	Last 1000 fueling data
DATE & TIME SETTING	Yes
VOLUME	6 digits 0.00-9999.99L
AMOUNT	6 digits 0.00-9999.99
UNIT PRICE	4 digits 0.001-9999
SHIFT ACCUMULATIVE VOLUME	12 digits
DAILY ACCUMULATIVE VOLUME	10 digits
MONTH ACCUMULATIVE VOLUME	10 digits
ACCUMULATIVE TOTAL VOLUME	12 digits

ORDERING INFORMATION

CAT NR.	BOX QTY.
AD/40/220/D	1



229

**Electric
DEF Transfer Pump**

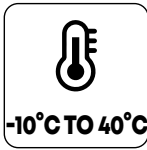
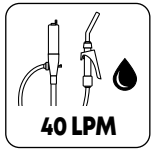

Vertical mount DEF transfer pump

Designed for safe & secure transferring of DEF from drums & totes

Built-in bung adapter fits directly on drums with 2" threaded opening

Manufactured from chemically inert materials, pumps work with a wide variety of low viscosity media

IPX4 Rated

Motor has double insulation making it safe for use with splashing water

Built-in anti-siphoning system ensures that media does not flow out by siphon action causing accidental damage to the delivery hose or dispensing nozzle

Pump comes complete with

- 2pc threaded Telescopic suction tube for use on 50-205 litre (15-55 gallon) drum & 1000 litre (275 gallon) totes
- Delivery hose
- Manual Dispensing Nozzle
- 2m Long Power Cable
- 2" Drum Bung

Duty Cycle

Continuous Duty

WETTED COMPONENTS

POM, PA, Stainless Steel, PP & Rubber

RECOMMENDED USE

DEF & Water based media

FLUIDS

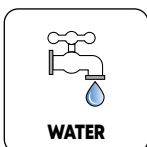

CE
IPX4
ISO 22241



WARNING

DO NOT USE
With fluids with a flash point below 100°F (38°C), such as Gasoline & Alcohol

Sparking could result in explosion causing fatal injury

VARIANTS

NEW!

CAT NR.	EOP/DEF/DC/12	EOP/DEF/AC/230
DESCRIPTION	12V DC	230V AC, 50 Hz
FLOW RATE	UPTO 35 LPM (9.25 GPM)	UPTO 40 LPM (10.5 GPM)
ABSORBED POWER	110 W	224 W
ABSORPTION	9.2 A	0.97 A
INSULATION CATEGORY	III	II
DISCHARGE HEAD	1 m (3.28 ft)	1 m (3.28 ft)
POWER CABLES	2 m	2 m
DELIVERY HOSE	2,5 m (8 ft)	2,5 m (8 ft)
OPERATING TEMPERATURE	-10°C to +40°C (14°F to 104°F)	-10°C to +40°C (14°F to 104°F)
NOISE LEVEL	70 dB	70 dB

ORDERING INFORMATION

CAT NR.	DESCRIPTION	BOX QTY.
EOP/DEF/DC/12	12V DC	4
EOP/DEF/AC/230	230V AC	4



DEF - Diesel Exhaust Fluid is a mixture of high purity synthetic automotive grade urea & de-ionised water. It is used in SCR (Selective Catalytic Reduction) system on diesel engines to reduce emissions

Designed to transfer DEF from a Drum/Tote to smaller container/engines etc.

FLUIDS

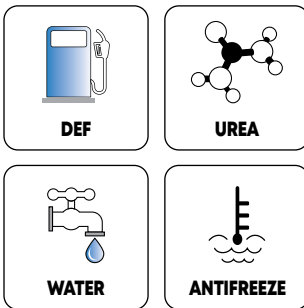

A DEF transfer system consists of

a. DEF Transfer Pump

- 220V AC Diaphragm pump with lightweight non-corroding polypropylene body

b. DEF Digital Meter

- Battery operated digital meter for use with DEF & water based media. Polyamide body & sealed electronic card makes it suitable for use in all sorts of weather conditions
- Measures in Litres, Quarts, Pints & Gallons

c. Inlet Hose

- Special EPDM inlet hose connecting the Drum/Tote opening to the pump inlet respectively

d. Suction Hose

- Special EPDM suction hose

e. Discharge Hose

- 20' special EPDM hose connecting the pump meter outlet to the dispensing nozzle

f. Connecting adaptor

g. Manual DEF Nozzle

- Nylon construction with SS hardware & Viton seals, Manual control, but also includes a continuous flow switch for unattended dispensing

h. Auto Shut Off DEF Nozzle

- Sensor built into the discharge spout automatically shuts off the supply once fluid level in the Drum/Tote reaches that of the outlet discharge spout

i. Nozzle Holder

- For safe storage of the nozzle while the fluid is not being dispensed

j. Mounting Plate

- Stainless Steel mounting plate for use in 1000/1200 litres (275/330 gallons) totes & 205 litre (55 gallon) drums
- Drum mounting plate is stretchable for varying drum dia and acts as base for installing pump & other accessories

ORDERING INFORMATION

CAT NR.	BOX QTY.
TOTE MOUNTING KIT	
KIT/IBC/DEF/1/EU	1
KIT/IBC/DEF/2/EU/D	1
KIT/IBC/DEF/3/EU/D	1
KIT/IBC/DEF/4/EU/D	1
KIT/IBC/DEF/5/EU/D	1
DRUM MOUNTING KIT	
KIT/DRM/DEF/1/EU	1
KIT/DRM/DEF/2/EU/D	1
KIT/DRM/DEF/3/EU/D	1
KIT/DRM/DEF/4/EU/D	1

SPECIFICATIONS

DESCRIPTION	DRUM MOUNT	TOTE MOUNT
INLET HOSE SIZE	3/4" ID	5' x 3/4" ID
DISCHARGE HOSE SIZE	20' x 3/4" ID	20' x 3/4" ID
INPUT VOLTAGE	220V AC	220V AC
MOTOR RATING	1/2 HP	1/2 HP
PROTECTION	IP55	IP55
DUTY CYCLE	30 mins ON / OFF	30 mins ON / OFF
ACCURACY*	± 1 %	± 1 %
REPEATABILITY*	0.30 %	0.30 %
MAX. WORKING PRESSURE	145 PSI (10 BAR)	145 PSI (10 BAR)
MAX. RESETTABLE BATCH TOTALIZER	99,999 units	99,999 units
MAX. NON RESETTABLE BATCH TOTALIZER	9,99,999 units	9,99,999 units
LEAST COUNT	0.001 units	0.001 units

*Tested in laboratory conditions

KIT-IBC

KIT-DRM

TOTE MOUNTING KIT

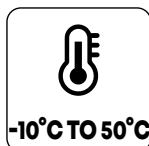
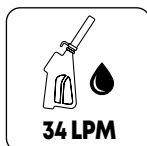

DRUM MOUNTING KIT

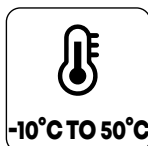
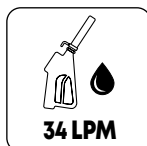

TOTE MOUNTING KIT PART LIST

	KIT/IBC/DEF/1/EU	KIT/IBC/DEF/2/EU/D	KIT/IBC/DEF/3/EU/D	KIT/IBC/DEF/4/EU/D	KIT/IBC/DEF/5/EU/D
	BASIC	BASIC WITH BOTTOM ADAPTOR	ADVANCED	PREMIUM	BASIC WITH BOTTOM ADAPTOR & METER
STAINLESS STEEL TOTE MOUNTING PLATE	Yes	Yes	Yes	Yes	Yes
ELECTRIC DEF PUMP	Yes	Yes	Yes	Yes	Yes
DEF DIGITAL TURBINE METER	-	-	-	Yes	Yes
DEF CONTROL NOZZLE-MANUAL	Yes	Yes	-	-	Yes
DEF CONTROL NOZZLE-AUTOMATIC	-	-	Yes	Yes	-
BOTTOM ADAPTOR	-	Yes	Yes	Yes	Yes
INLET HOSE	Yes	Yes	Yes	Yes	Yes
DISCHARGE HOSE	Yes	Yes	Yes	Yes	Yes
CONNECTING HARDWARE	Yes	Yes	Yes	Yes	Yes

DRUM MOUNTING KIT PART LIST

	KIT/DRM/DEF/1/EU	KIT/DRM/DEF/2/EU/D	KIT/DRM/DEF/3/EU/D	KIT/DRM/DEF/4/EU/D
	BASIC	BASIC WITH CONNECTING ADAPTORS	ADVANCED	PREMIUM
STAINLESS STEEL DRUM MOUNTING PLATE	Yes	Yes	Yes	Yes
ELECTRIC DEF PUMP	Yes	Yes	Yes	Yes
DEF DIGITAL TURBINE METER	-	-	-	Yes
DEF CONTROL NOZZLE-MANUAL	Yes	Yes	-	-
DEF CONTROL NOZZLE-AUTOMATIC	-	-	Yes	Yes
CONNECTING ADAPTORS	-	Yes	Yes	Yes
INLET HOSE	Yes	Yes	Yes	Yes
DRUM BUNG CONVERTOR	-	Yes	Yes	Yes
DISCHARGE HOSE	Yes	Yes	Yes	Yes
SUCTION HOSE	Yes	-	-	-
CONNECTING HARDWARE	Yes	Yes	Yes	Yes



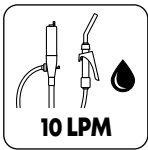

High flow battery operated pump for quick & convenient transfer of diesel, kerosene, light oils & water based media

Ideal for transferring small quantities of media into boats, garages & small shops

Self priming pump with 3V DC motor

Pump is operated by sliding the actuation button located on top

Suitable for use on 20 litres/ 5 gallon pails

Works on 2 "D" size (LR20) Alkaline Batteries (not included with the pump). Approx working life with one set of batteries is 1000 litres (265 gallons)

Complete with 23-1/2" (600 mm) long flexible corrugated discharge hose

Hang Hole provided at top allows pump to be conveniently stored when not in use

Hose holder for convenient storage of hose after use to avoid spillage

WETTED COMPONENTS

Polypropylene, Polyethylene, Acetal, NBR, PVC & PET

RECOMMENDED USE

Diesel, Kerosene, Light Oils, Water, DEF, Antifreeze, Windshield washer water, Mild Detergent, Agriculture chemical

DO NOT USE WITH

Any media not compatible with materials used in the pump construction

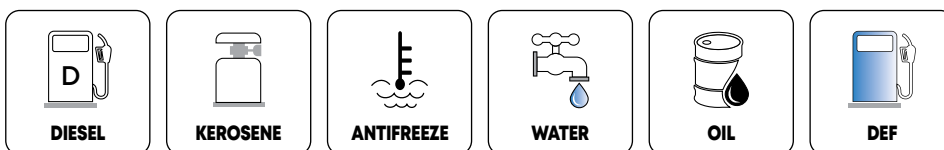
FLUIDS

ORDERING INFORMATION

CAT NR.	TOTAL LENGTH		SUCTION TUBE LENGTH		BOX QTY.
	(INCH)	(MM)	(INCH)	(MM)	
BOP/5A	23	585	15.15	385	40

WARNING

Pump must never be used with hot media at temperatures above 60°C (140°F)

232

Dry Cell DEF Pump

BOP-50

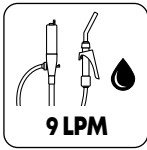

Battery operated pump for quick & convenient transfer of Gasoline, Diesel, DEF, Water & water based media

Self priming pump with 3V DC motor

Convenient to operate trigger for Full control on fluid outflow No spillage even when the electric switch is On

Works on 2 'D' size (LR20) alkaline batteries, not included with the pump

Approximate working life with one set of batteries - 1000 litres (264 gallons)

Duty cycle: 10 min ON/ 10 min OFF

WETTED COMPONENTS

Polypropylene, Polyethylene & Acetal

RECOMMENDED USE

Petrol, Diesel, Kerosene, DEF, Antifreeze, Windshield Fluid, mild detergents, agricultural chemicals, Herbicides Pesticides & Water

DO NOT USE WITH

With Acids, Acetone, Benzene etc



1m (3.3') long flexible corrugated hose



Hook for safe keeping of nozzle when not in use

FLUIDS

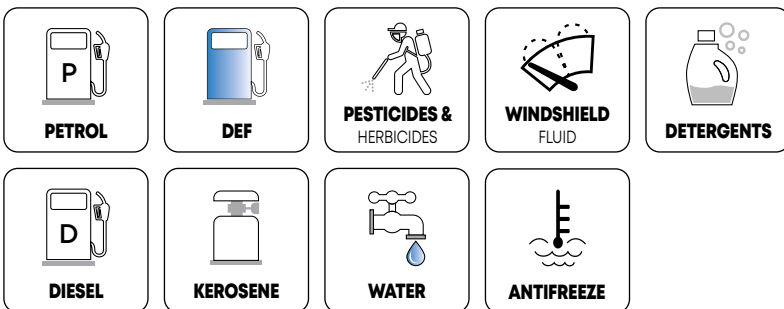

ORDERING INFORMATION

CAT NR.	TOTAL LENGTH		SUCTION TUBE LENGTH		BOX QTY.
	(INCH)	(MM)	(INCH)	(MM)	
BOP/50	26-1/2	674	18-3/8	467	40



WARNING

Pump must never be used with hot media at temperatures above 60°C (140°F)



233

Rechargeable DEF Pump

BOP-60

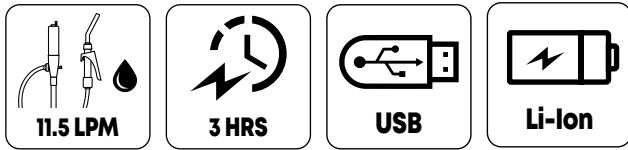

Rechargeable Battery Operated Pump for quick and convenient transfer of wide variety of fluids

Lightweight yet sturdy pump with convenient to operate large ON/OFF switch

Pump complete with

- Control Nozzle** with lever for:
 - Full control on fluid outflow
 - No spillage even when the electric switch is ON
- Telescopic Suction Tube** adjustable 15"-20-1/2" (380-520 mm) suitable for use on 20 to 50 litre drums
- 1.5m (4.9 ft) Flexible Hose** with swivel at end to prevent kinking of hose

Convenient & Safe Storage Hang pump onto the supply tank via the U-shaped hook after use

Power Source

2900mAh Rechargeable Lithium ion battery. Rechargeable via USB 2.0 type B connector (USB cable included)

Battery Capacity

Fully charged battery can discharge upto 300 litres*
*tested using water

WETTED COMPONENTS

Polypropylene, Polyethylene, PVC & Acetal

RECOMMENDED USE

Diesel, Kerosene, Light oils, DEF, Water, Antifreeze, Windshield fluid, Mild detergents, Agricultural chemicals etc

DO NOT USE WITH

Acids, Acetone, Benzene etc

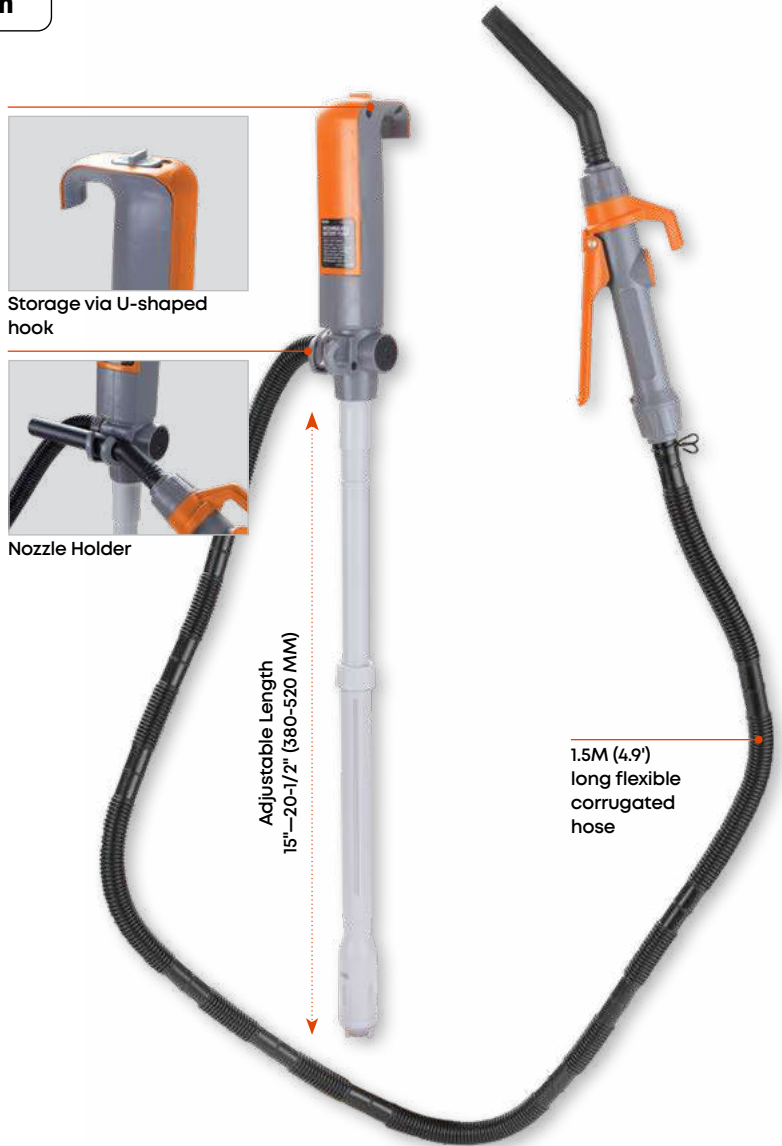

FLUIDS

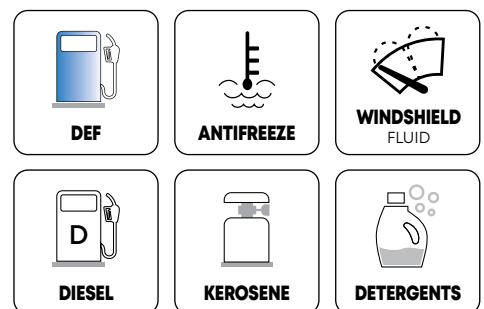

ORDERING INFORMATION

CAT NR.	BOX QTY.
BOP/60	10

WARNING

Pump must never be used with hot media at temperatures above 60°C (140°F)

234

Electric Drum / IBC Pumps

EDR-55

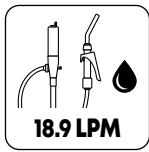

Worlds 1st Rechargeable Battery Operated Pump

Built-in fuse for overload protection

Silenced motor makes almost no noise

Telescopic suction tube extends from 33-1/2" (850 mm) to 49" (1245 mm) for use with 210 litre drums or 1000-1250 litre IBC / Totes

SS filter built into the suction tube inlet prevents contamination

Built-in 2" bung adaptor fits directly on 210 litre metal drums. Bung adapter can be adjusted by 0.6" (15 mm) to adjust to drums with varying heights

Supplied complete with 2m (6.6') hose & manual dispensing nozzle with 3/4" (19 mm) OD Stainless Steel Spout

Duty Cycle

15 minutes ON / 15 Minutes OFF

WETTED COMPONENTS

Viton, POM, Stainless Steel, PE, NBR, PP

DO NOT USE WITH

Petrol, Corrosive chemicals, Lacquer thinners, any material that is not compatible with the pump construction

SPECIFICATIONS

MOTOR TYPE	DC Brush Motor (5 Pole)
DC POWER CABLE	4M long with Crocodile Clips
AC POWER ADAPTER	Input: 100 to 240 V AC, 50 / 60 Hz, Output: 12 V DC Constant Voltage, 3A max
RECHARGEABLE BATTERY	18.5V, 1.3Ah Li-Ion Rechargeable Battery
MAX. VISCOSITY OF MEDIA	100 cst
TEMPERATURE	5°C to 40°C (41°F to 104°F)

ORDERING INFORMATION

CAT NR.	BOX QTY.
EDR/55T/AC/EU	4



3/4" (19 mm) SS spout

Lift handle

Bung with standard 2" threads

Thread converter (With 2.5 x 5 mm Butress threads)

Telescopic suction tube

SS strainer

55.5 mm

On/off switch with LED indicator

Pump outlet with swivel connection

Manual dispensing nozzle

Flexible corrugated hose 2m (6.6') long

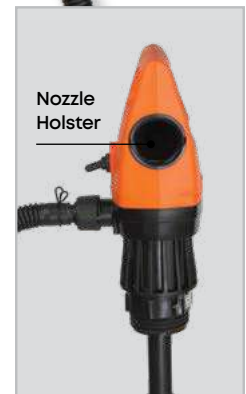

Nozzle Holster



With 100V-240V, 50/60 Hz AC Dual Voltage Power Adaptor

FLUIDS

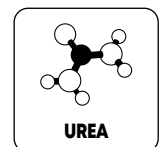
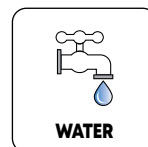
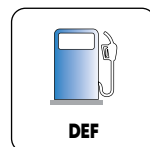
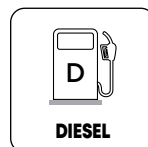

235

Rotary Drum Pump Stainless Steel

GNB-SS



Superior quality stainless steel hand operated rotary drum pump

Choice of construction materials: Stainless steel body with stainless steel bung & suction tube

Rotor with PTFE vanes & seals makes it resistant to corrosion & useful for transferring a wide variety of fluids such as water based media, chemicals, all petroleum products etc.

Superior machining of vanes ensures better draw & smooth delivery

Fits 50 to 205 litres (15 to 55 gallon drums)

Comes complete with

- Pump Body
- 2" Bung Adaptor
- Handle
- Discharge Spout
- 3 pc Suction tube

WETTED COMPONENTS

Stainless Steel 304, PTFE

RECOMMENDED USE

Water based media, antifreeze, acids, chemicals, all petroleum based products, lacquer, thinner, urea, DEF

DO NOT USE WITH

Hydrochloric acid, Sulphuric acid etc.

FLUIDS

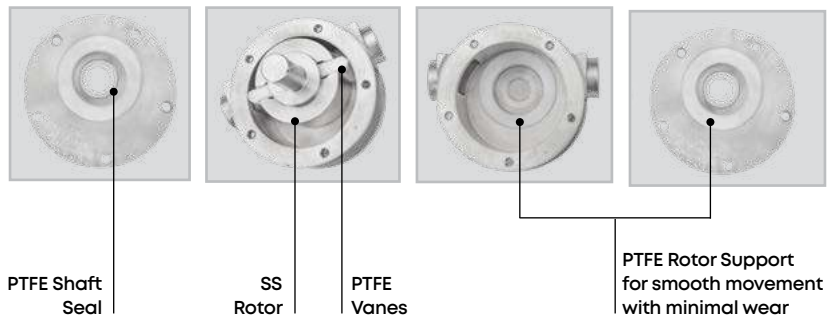
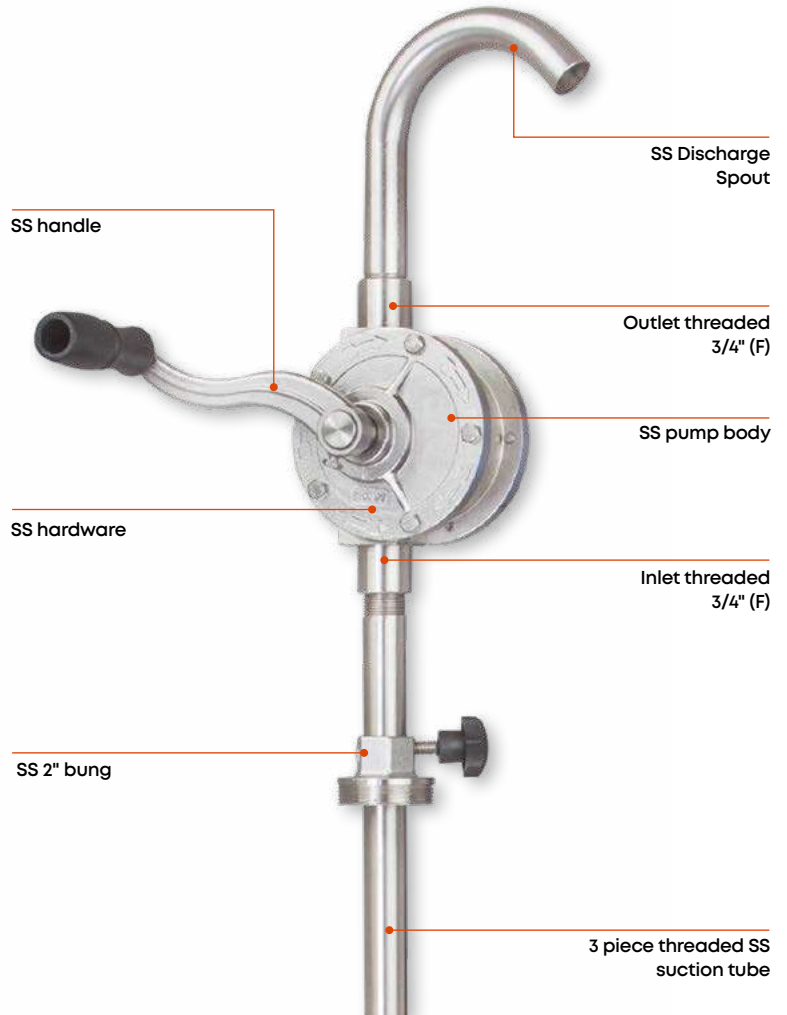
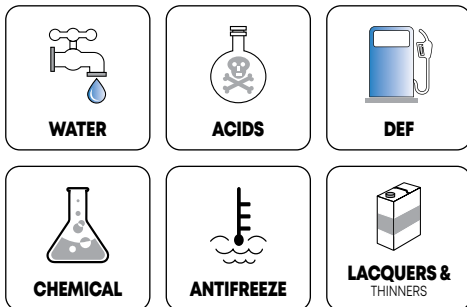

ORDERING INFORMATION

CAT NR.	PUMP INLET/OUTLET	BOX QTY.
GNB/SS/25/3R/SPL	3/4" (F)	4

236

Plastic Lever Pump

PLP-10

NEW!



Lever action piston pump for use with water and water based fluids, DEF, Windshield washer, Antifreeze, Agricultural chemicals, lubricants etc

Ergonomic design for fatigue free use

Double blade piston for higher suction power

2" bung adaptor with a flared design for convenient tightening on the drum

Pump outlet fitted with air vent cap that can be turned counter-clockwise to break the siphoning action and stop flow

Complete with:

- Telescopic suction tube for use with 50-205 litre (15-55 gallon drums)
- 2m x 3/4" (19 mm) flexible hose

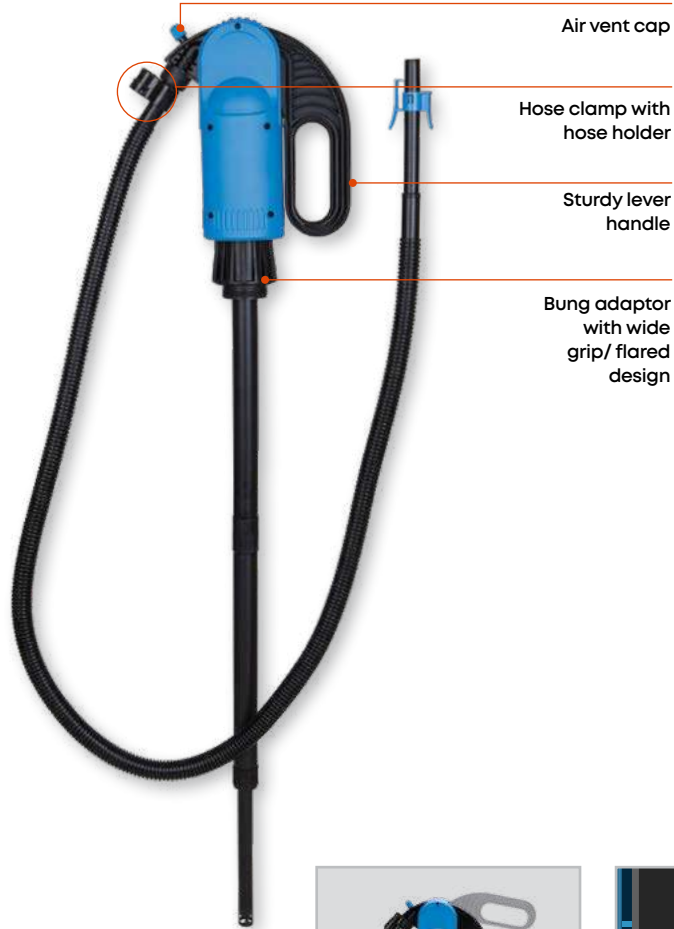

SPECIFICATIONS

FLOW RATE	UPTO 350 ML /STROKE	
WORKING TEMPERATURE	+5°C TO 40°C	41°F TO 104°F

FLUIDS

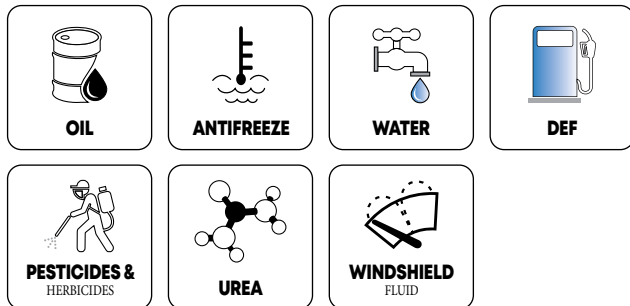

ORDERING INFORMATION

CAT NR.	BOX QTY.
PLP/10	4
PLP/10T	4



Lever Handle Convenient Up-Down Movement

- Sturdy grip with ergonomic design
- Convenient & smooth lever operation with min. force

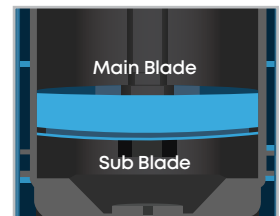

Double Blade Airtight Design

- Quick to Prime
- Pump holds prime longer than other pumps in market



Swivel Bung Adaptor

- Pump swivels freely on the bung adaptor making it convenient to use it at any position
- Large bung is easy to tighten & loosen



Discharge Hose

Superior quality fracture resistant hose will not crack or kink even after repeated use



237

Nylon Chemical Pump

CMP-12

Self priming Vertical Lift pump

Nylon construction with stainless steel plunger rod & PTFE seals

Complete with 2" polypropylene bung adaptor

Suitable for use on 210 litre drums

WETTED COMPONENTS

Nylon, Polypropylene, Stainless Steel & PTFE

RECOMMENDED USE

Lacquer, Thinners, Detergents, Glycerine, Water, Weed Killer, Brake Kleen, Mild Acids & Petroleum Based Media

DO NOT USE WITH

Strong Acids, Bleach & Petrol

FLUIDS

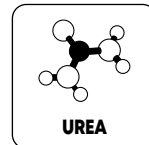
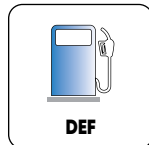
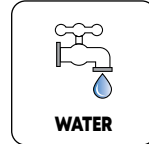

ORDERING INFORMATION

CAT NR.	FLOW RATE UPTO	BOX QTY.
CMP/12	400 ml (14 oz) /stroke	10

238

Plastic Rotary Pump

PRP

Special application pump designed to be used with a wide variety of media that cannot be pumped using a regular cast iron or steel pump

Body made from glass filled polypropylene with ryton vanes

Viton rubber seal & stainless steel hardware

Complete with 3 pc threaded suction tube suitable for use on 50-210 litre drums

WETTED COMPONENTS

Polypropylene, Ryton, Viton & Stainless Steel

RECOMMENDED USE

Water based media, acids, chemicals, detergents, benzene, glycerine etc.

DO NOT USE WITH

Acetone, Lacquer, Mineral Oils, Solvents, Turpentine etc.



ORDERING INFORMATION

CAT NR.	BOX QTY.
PRP/01	6



239

DEF Control Nozzle Manual

FCN-NY



20-90 LPM



72.5 PSI



UPTO 60°C

For use with DEF, urea, windshield fluids & other water based media

Nylon construction with stainless steel internal parts & viton seal

Nozzle spout with notches to avoid the gun from slipping from the tank during delivery

Manual control. Also includes continuous flow switch for unattended dispensing

Designed for minimal back pressure & reduction in flow

WETTED COMPONENTS

Nylon (Nylon 6, 30% glass Filled), Stainless Steel, Viton

FLUIDS



UREA



DEF



WATER

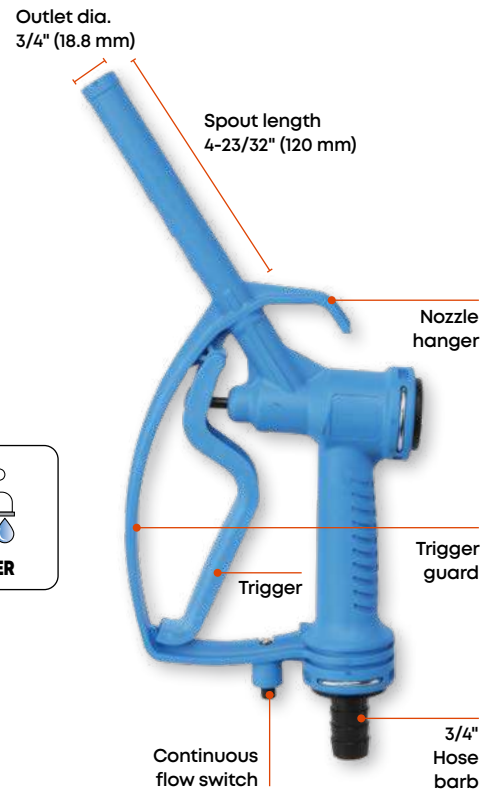

ORDERING INFORMATION

CAT NR.	SPOUT DIA. (OD)		SPOUT DIA. (ID)		BOX QTY.
	(INCH)	(MM)	(INCH)	(MM)	
FCN/NY/HB/3-4	3/4	18.8	9/16	14.6	1

240

DEF Control Nozzle Automatic

FCNA-SS



45 LPM



50 PSI



-10°C TO 50°C

For use with DEF, Urea, Windshield fluids & Other based media

Heavy duty stainless steel cast body with polyamide cover

Sensor built into the discharge spout automatically shuts off the supply once fluid level in the tank reaches that of the outlet discharge spout

Built-In stainless steel swivel for ease of use

WETTED COMPONENTS

SS 304, N41

FLUIDS



E85



UREA



DEF



WATER

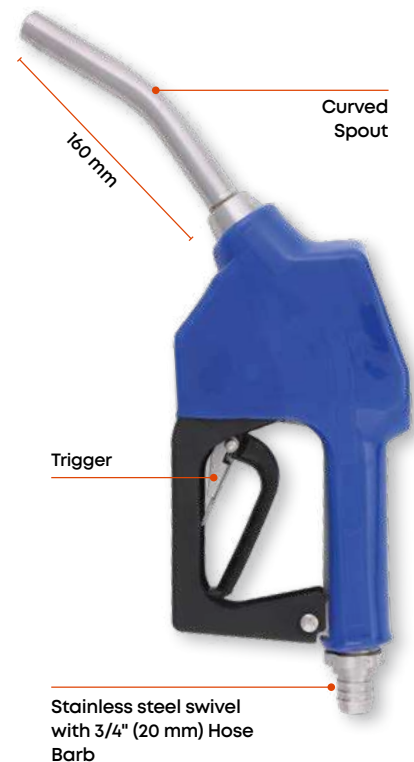

ORDERING INFORMATION

CAT NR.	SPOUT DIA. (ID)		SPOUT DIA. (OD)		BOX QTY.
	(INCH)	(MM)	(INCH)	(MM)	
FCNA/SS/HB/3-4	5/8	16	47/64	18.5	1

241

Plastic Lever Pump Value

PLP-20

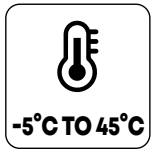

Lever Action Drum Pump suitable for use with fluids of varying viscosities

Construction:

Polypropylene body, handle and outlet spout

Stainless Steel piston rod and Viton seal

Strainer built into suction tube inlet to keep contaminants away

Complete with

- Two piece telescopic suction tube for use with 50-205 litres (15-55 gallons) drums
- Outlet spout

WETTED COMPONENTS

Polypropylene, Viton, Stainless steel

RECOMMENDED USE

Petroleum-based non-corrosive liquids
 Fuels: Diesel, Kerosene, Light oils, Low viscosity lubricants, Acetone, Anti-freeze, Ammonium Hydroxide, Glycerine, Alcohols, Water, Water based chemicals. Weaker acids, Mild solvents and Alkaline solutions.

DO NOT USE WITH

Lubricant or liquids above 100 cst or any media not compatible with materials used in the pump construction

FLUIDS

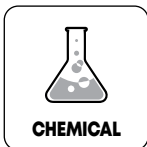
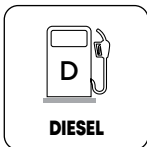
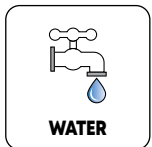

ORDERING INFORMATION

CAT NR.	BOX QTY.
PLP/20	10



VARIABLE HANDLE SETTING

FLOW SETTING	LOW FLOW 1	MEDIUM FLOW 2	HIGH FLOW 3
FLOW RATE*	Upto 270 ml (9 Oz.) /Stroke	Upto 350 ml (12 Oz.) /Stroke	Upto 430 ml (15 Oz.) /Stroke
TYPE OF FLUIDS	Lubricants or liquids under 35 cst	Anti-freeze, Alcohols, Water, Water based chemicals, low viscosity lubricants	Diesel, Kerosene, Petroleum-based non-corrosive liquids upto 100 cst

* Measured at pump outlet. Tested using water

Telescopic Suction Tube
 24-3/8"—35-1/2"
 (620-900 mm)

Strainer

242

Siphon Pumps

SPH

Easy to use, polyethylene pumps siphon liquids to lower levels than the height at which the pump is installed

These are easy to prime & start within 6-7 strokes

Pump requires no further operation & keeps working in auto position.

All pumps are equipped with a vent cap on top. Opening the cap stops discharge

To dispense media at levels higher than the pump, pump below needs to be continuously operated

Supplied complete with flexible corrugated discharge tube

RECOMMENDED USE

Water-based fluids, detergents, waxes, soaps, antifreeze, some mild acids, and other liquids compatible with pump construction materials
Pump should only be used with light weight & non-flammable liquids

DO NOT USE WITH

Any media not compatible with materials used in the pump construction



Vent cap

FLUIDS

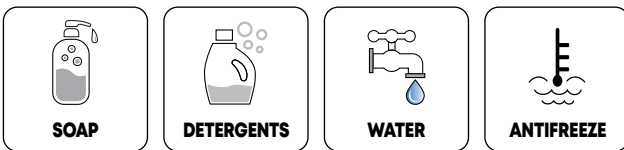

VARIANTS

SPH/1	SPH/2	SPH/3
<p>15-1/4" (387 mm)</p>	<p>33" (839 mm)</p>	<p>32-1/2" (824 mm)</p>
WETTED COMPONENTS Polyethylene	WETTED COMPONENTS Polyethylene & Polypropylene	WETTED COMPONENTS Polyethylene & Polypropylene

WARNING

Pumps must never be used with hot media at temperatures above 60°C (140°F)

These pumps must never be used with concentrated acids, Acetone, Benzene etc.

ORDERING INFORMATION

CAT NR.	FLOW RATE		BUNG	FITS	DISCHARGE HOSE LENGTH		BOX QTY.
	(LPM)	(GPM)			(INCH)	(MM)	
* SPH/1	6.5	2	1-1/2" for use with pails	5-20 litre / 5 gal. pails	21.69	551	25
* SPH/2	17.5	5	2" for use with drums	205 litre / 55 gal. drums	46.45	1180	25
* SPH/3	21	7	2" for use with drums	205 litre / 55 gal. drums	47.70	1212	25



243 Siphon Pump With Back Flow Valve SPH-10

NEW!

Portable & easy to use hand operated pumps for clean, quick, hassle free transferring or evacuating of a wide variety of media including light oils, water based media, Diesel, Kerosene & Gasoline

Easy to use, insert the siphon hose into the liquid, pump the bulb, and gravity does the rest

Back flow valve - Prevents unwanted reverse flow of liquid

Comes complete with 2 x 2.7' (820 mm) long PVC hose attached to a bulb

Suitable for automotive maintenance, professional mechanic shops & garages

WETTED COMPONENTS

Polypropylene, HDPE & PVC

DO NOT USE WITH

Any media not compatible with materials used in pump construction



HOW TO USE



STEP - 1
Ensure that the indicator arrow on the rubber ball is facing down



STEP - 2
Place the fluid suction hose into the source container. Put the discharge hose in the target container

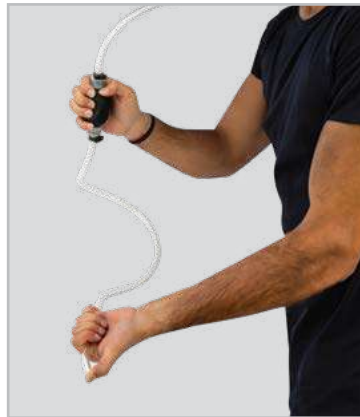

STEP - 3
Place your thumb over the bottom end of the discharge hose and squeeze the rubber pump a few times to start fluid transfer. Gravity does the rest

FLUIDS

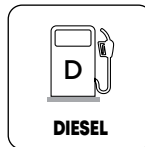
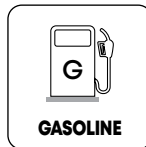
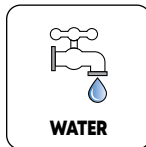

ORDERING INFORMATION

CAT NR.	DESCRIPTION	BOX QTY.
SPH/10NR	With back flow valve	10

244

Two-In-One Transfer Pump

BLG-5Q
NEW!

Polypropylene construction

Portable hand operated pump for clean, quick & hassle free transferring of low viscosity fluids, including water and oil

Small & lightweight, these fit easily in a tool box or trunk of a car

Comes with air hose hence can also be used as an air pump for inflating beach balls, cycle tyres etc.

Suitable for use in garages, homes, cars, boats and can also be used with standard gallon containers

RECOMMENDED USE

Light oils and water based media



QUICK-CONNECT ADAPTOR DESIGN



For quick connect & greater holding power, eliminating mess caused by loose hose



Easily dis-connect hose:
Press the adaptor inwards

2 IN ONE PUMP

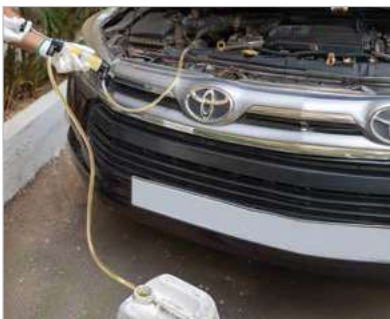

Pump can transfer light viscosity fluids when attached to 2 x 50" long clear hoses



Pump can be used as an air pump by simply attaching air hose & air nozzles for different purposes

ORDERING INFORMATION

CAT NR.	DESCRIPTION	BOX QTY.
BLG/5Q	With Quick Connect Adaptor	10



245 Drum Trolley Low Profile TRL-55

Low Profile Drum Trolley

Drum platform only 1/2" (12 mm) off the floor, facilitating easy loading & unloading

Extra heavy duty construction, from 5 mm (6 gauge) steel sheet, with a loading capacity of 545 kgs (1200 lbs)

Fully powder coated finish

Removable pivoting handle includes drum tipper for easy loading

2 large Phenolic front wheels 5-3/4" dia. (146 mm) × 1-7/8" (47 mm) wide & one back phenolic swivel wheel 3" (75 mm) dia. × 1-3/8" (35 mm) wide

Trolley can accommodate drums up to a dia. of 26" (660 mm)

Unit comes flat packed in semi-knocked down condition for ease of transport

Suitable for 210 litre drums



ORDERING INFORMATION

CAT NR.	BOX QTY.
TRL/55	1

246 Drum Wrench DRW

An easy & convenient tool to open almost all types of drums

Manufactured from cast aluminum (LM25), hardened & tempered for increased strength

Ends of the wrench are designed to fit perfectly onto most 2" & 3/4" drum plugs

Compact design for easy storage



For opening hex plugs

For opening 2" drum plugs

For opening 3/4" drum plugs



ORDERING INFORMATION

CAT NR.	BOX QTY.
DRW/AL-01	10

247

4 Wheel Drum Dolly

BDL-140

Extra heavy duty drum dolly for convenient movement of 180 kg/ 210 litre drums in shop floors & rough workshop environment

Manufactured from solid 3 mm (11 guage) steel sheet

Design incorporates wide steel cross bases for full base support

Premium powder coated finish

Firmly welded solid cast iron 4 wheels (75 mm dia. x 35 mm wide)

Holds drums of dia. 23" (584 mm)

Overall Height
6-1/2" (165 mm)

Loading Capacity
545 kg (max)



ORDERING INFORMATION

CAT NR.	BOX QTY.
BDL/140S	2

248

Drum Cradle

DRC-135

Tilting Drum Cradle
Tips, rotates, moves & stores
400 lbs. / 180kg / 210 litre / 55 gal. drums

Large 2-1/2" (63 mm) non-sparking wheels make it suitable for use in flammable environments

Fully powder coated finish

Equipped with self storing lever bar

Maximum load 600 lbs. / 273 kgs

Unit comes flat packed in semi-knocked down condition for ease of transport



ORDERING INFORMATION

CAT NR.	BOX QTY.
DRC/135	3

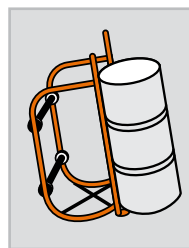

Just Tip

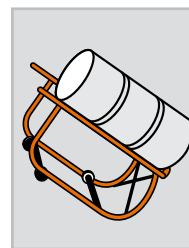

Tilt

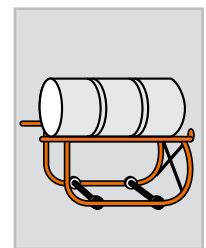

Drain



Rugged build with outstanding features make these trolley ideal for use in workshops & industrial floors for transfer of large drums & buckets

Manufactured from heavy gauge 4 mm thick steel sheet for increased strength & durability

3" (75 mm) ground clearance for smooth movement over uneven surfaces in workshop environment

6" (150 mm) wide polyurethane front wheels with nylon rim for reduced wear & tear

Heavy duty rear castors with toe locks for higher safety & stability

Available in 2 sizes

- a. Trolley for 50 kg / 120 lb. drums
- b. Trolley for 180 kg / 210 litre / 55 gal. drums. Can be used just as a trolley for safe movement of oil drums or a complete dispensing system with hose reel & pneumatic pump



TRL/50	TRL/180H
	
Trolley for 50 kg / 120 lb. drums	Trolley for 180 kg / 55 gal. / 205 litre drums

TRL-180H
TRL-50

Drum clamping attachment



Clamps for holding pump when not in use

Plate for mounting a hose reel

Cup for secure holding of pump inlet & collecting dripping oil

Heavy Duty 4 mm thick steel sheet

6" (150 mm) polyurethane wheels with nylon rim



Control gun holder

Removable handle used for moving the trolley



Removable handle used as a drum loader



Removable handle used as a drum wrench



Lock position



Un-lock position



Heavy Duty castors with toe lock

ORDERING INFORMATION

CAT NR.	SUITABLE FOR	BOX QTY.
TRL/50	50 kg / 120 lb. drums	1
TRL/180H	180 kg / 55 gal. / 205 litre drums	1



Trolley being used as a dispensing system with Ratio Pump & Hose Reel installed



250

Drum Cart Heavy Duty

CART

Tough built carts for convenient movement of drums in workshops and industrial environments

Manufactured from heavy gauge thick steel sheet in premium powder coated finish

Upto 3" (75 mm) ground clearance for smooth movement over uneven surfaces, a common feature in workshop environments

10" dia front wheels.

5" nylon rear castors with toe lock for high safety & stability

Heavy duty, adjustable metallic chain secures drum to the cart and prevents any accidental tipping off during movement

Unit comes flat packed in knocked down condition for ease of transport



SPECIFICATION

SUITABLE FOR	FOR 180 KG / 205 LITRE / 55 GAL. / 400 LB. DRUMS
STEEL SHEET THICKNESS	1/2" (12 MM)
GROUND CLEARANCE	2" (50 MM)
MAX LOAD CAPACITY	350 KG (770 LBS)
HOLD DRUMS	DIA. UPTO 25-5/8" (650 MM)

ORDERING INFORMATION

CAT NR.	CAT NR.	BOX QTY.
PNEUMATIC WHEELS	PHENOLIC WHEELS	
CART/400P	CART/400	1





CART/400P
Cart for safe movement of drums or complete dispensing systems with hose reel & pneumatic pump (Sold as cart only)

251 Air Blow Guns Standard

ABG-3
ABG-1

50-235 PSI



-10°C TO 70°C

FACTORY TESTED

OSHA STD 1-13.1 FOR SAFETY
Max. Working Pressure 6 Bar (90 PSI)

OSHA STD 1910-95(b) FOR NOISE
Max. Working Pressure 6 Bar (90 PSI)

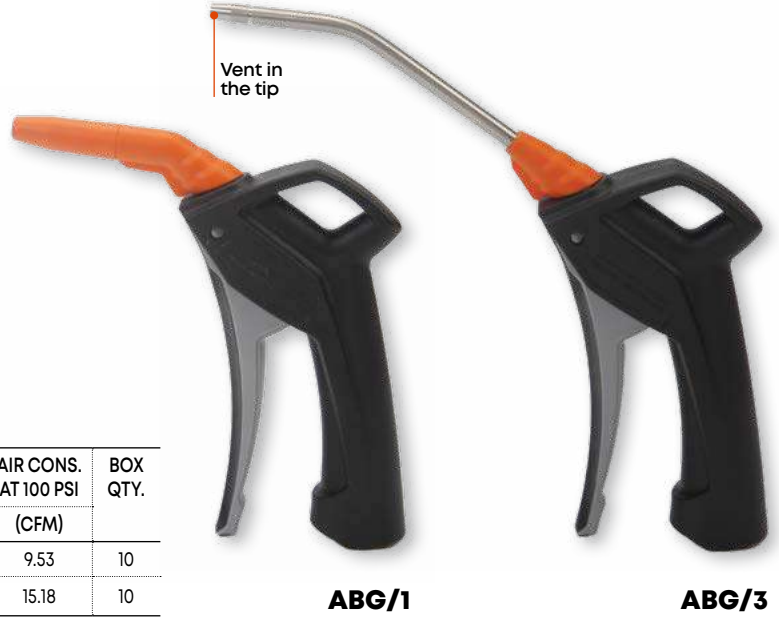
- Designed for rugged everyday usage
- Impact resistant nylon body with stainless steel nozzle
- Variable speed trigger allows complete control on the volume of air dispensed
- Threaded brass insert at the air inlet
- Ergonomic soft rubber grip on handle



ORDERING INFORMATION

CAT NR.	TIP	NOISE	BLOWING FORCE AT 100 PSI	AIR CONS. AT 100 PSI	BOX QTY.
		(DB)	(KG)	(CFM)	
ABG/1/1-4F/BSP	Plastic	77	0.26	9.53	10
ABG/3/1-4F/BSP	4-1/2" SS nozzle	80	0.35	15.18	10

252 Air Blow Gun Professional

ABG-10

FACTORY TESTED

50-150 PSI



-10°C TO 70°C

OSHA STD 1-13.1 FOR SAFETY
Max. Working Pressure 6 Bar (90 PSI)

OSHA STD 1910-95(b) FOR NOISE
Max. Working Pressure 6 Bar (90 PSI)

- Lightweight Air Blow Gun manufactured from glass filled polypropylene
- Impact & weather resistant construction
- Brass threaded air inlet ensures that threads do not shear with repeated use
- Extended trigger for variable speed control
- Rust-proof stainless steel nozzle

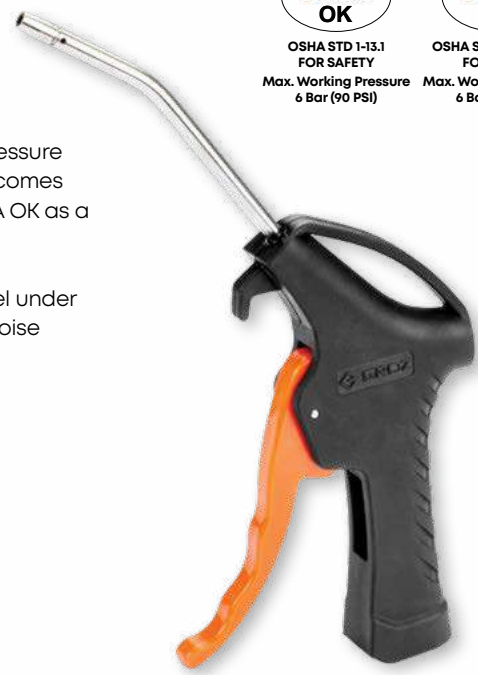
- Vent in the gun tip prevents pressure from exceeding 30 PSI if tip becomes blocked, making the gun OSHA OK as a safety blow gun
- Silent operation with noise level under 80db, the gun is OSHA OK for noise
- Comes with 4-1/2" steel tip



ORDERING INFORMATION

CAT NR.	BOX QTY.
ABG/10/1-4F/BSP	10

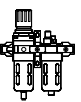

253

Filter Regulator Combination

FRC



Compact combination unit for removing contaminants & moisture from compressed air in addition to regulating air pressure

Regulator has a non raising "Press to Lock" adjusting knob for locking at any set pressure

Filter is designed with a separator & shield for efficient moisture separation

Supplied complete with pressure gauge & wall mounting bracket



ORDERING INFORMATION

CAT NR.	DESCRIPTION	INLET/ OUTLET PORT SIZE	PRESSURE GAUGE PORT SIZE	MAX. FLOW RATE	BOX QTY.
FRC136134-S/GB	Miniature	1/4" BSP	1/8" BSP	550 LPM (20 CFM)	1
FRC156334-S/GB	Standard	1/2" BSP	1/8" BSP	3,000 LPM (106 CFM)	1

SPECIFICATIONS

PRESSURE ADJUSTMENT RANGE	7 - 145 PSI (0.5 to 10 BAR)
FILTERING ELEMENT	Sintered Bronze (40 micron)
DRAIN TYPE	Semi Automatic

254

Filter Regulator & Lubricator 2 Piece

FRCLM



Space saving 2 pc modular filter-regulator combination & lubricator

Filter removes contaminants & moisture from compressed air

Regulator has a non raising "Press to Lock" adjusting knob for locking at any set pressure

Lubricator feeds lubricants to air operated equipment maintaining a constant oil-to-air density over a wide range of flow

Supplied complete with pressure gauge & wall mounting bracket

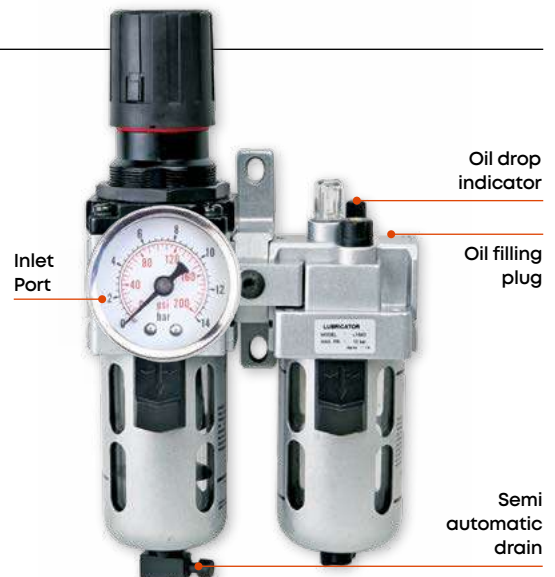

ORDERING INFORMATION

CAT NR.	CAT NR.	DESCRIPTION	INLET/ OUTLET PORT SIZE	PRESSURE GAUGE PORT SIZE	MAX. FLOW RATE	BOX QTY.
WITH GAUGE	WITHOUT GAUGE					
FRCLM136134-S/WG	FRCLM136134-S/G	Miniature	1/4" BSP	1/8" BSP	500 LPM (18 CFM)	1
FRCLM156334-S/WG	FRCLM156334-S/G	Standard	1/2" BSP	1/8" BSP	2,800 LPM (99 CFM)	1

SPECIFICATIONS

PRESSURE ADJUSTMENT RANGE	7 to 145 PSI (0.5 to 10 BAR)
FILTERING ELEMENT	Sintered Bronze (40 micron)
DRAIN TYPE	Semi Automatic

255

Digital Air Pressure Gauge

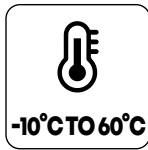
DPG

CE
IP65

Used with air regulators for setting air output pressure

Digital read out displays air pressure in a choice of 4 units: PSI, BAR, MPa & kg/cm²

Digital gauges offer higher accuracy and can also withstand vibrations due to pressure variations

Square body has die cast aluminum centre back

Single button operated with auto turn off after 120 seconds that extends battery life



SPECIFICATION

ACCURACY	± 2% of Full Scale
MEASURING RANGE	- 15 to 145 PSI
LEAST COUNT	0.1 PSI (0.01 BAR)
WORKING TEMPERATURE	- 10°C to +60°C
WORKING HUMIDITY	35 ~ 85% RH
BATTERY	CR 2032 lithium (included)
BATTERY LIFE (APPROX.)	1 year (usage 5 times a day)

ORDERING INFORMATION

CAT. NR.	THREADS	BOX QTY.
DPG/L/1-8/B	1/8" BSPT(M)	10
DPG/L/1-4/B	1/4" BSPT (M)	10



Reliable and sturdy, the 3 in 1 GROZ tyre gauge is designed to:

1. Measure Tyre Pressure
2. Inflate Tyres
3. Deflate Tyres

Tyre deflation is via the deflation valve on the gun body. A simple press of the valve will activate it and reduce pressure.

Aluminium die cast gun with flexible hose & straight chuck suitable for cars & other light vehicles

SPECIFICATION

GAUGE TYPE	DIGITAL
GAUGE DIAMETER	2-1/2" (63 mm)
BACKLIGHT	Yes
AVAILABLE UNIT SELECTION	PSI, BAR, Mpa, Kg/cm ²
MAX. PRESSURE	Upto 300 PSI (21 BAR)
ACCURACY	± 1% of Full scale
RESOLUTION	0.1 PSI
POWER SUPPLY	Lithium Battery

ORDERING INFORMATION

CAT NR.	DESCRIPTION	BOX QTY.
TIG/D/12/BSP	12" (300 mm) flexible hose with straight chuck; Digital Gauge	10

257

Tyre Inflator Gauge for Trucks

TIG-24

Reliable and sturdy, the 3 in 1 GROZ tyre gauge, the 3 in 1 GROZ tyre gauge is designed to:

1. Measure Tyre Pressure
2. Inflate Tyres
3. Deflate Tyres

Tyre deflation is via the deflation valve on the gun body. Simple press of the valve activates it and reduces pressure

Aluminium die cast gun with flexible hose, rigid extension & dual chuck suitable for attachment on valves of large tyres



SPECIFICATION

GAUGE TYPE	Digital
GAUGE DIAMETER	2-1/2" (63 mm)
BACKLIGHT	YES
AVAILABLE UNIT SELECTION	AR PSI, BAR, Mpa, Kg/cm ²
MAX. PRESSURE	upto 300 PSI (21 BAR)
ACCURACY	± 1% of Full scale
RESOLUTION	0.1 PSI
POWER SUPPLY	Lithium Battery

ORDERING INFORMATION

CAT NR.	DESCRIPTION	BOX QTY.
TIG/D/24D/BSP	24" (600 mm) flexible hose with dual chuck; Digital Gauge	10

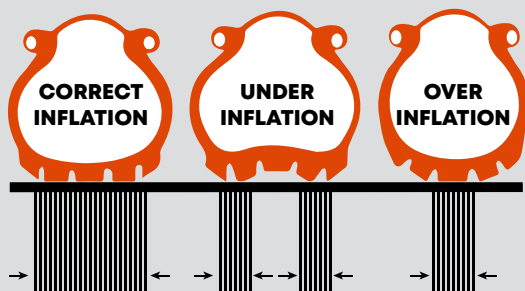

MAINTAINING CORRECT TYRE PRESSURE

Under-inflated tyres heats up more quickly than correctly inflated tyres, and in extreme cases can lead to tyre failure

Driving on under-inflated tyres also places excess stress on the tyre shoulders, causing uneven wear of the tread

Over-inflation causes high wear at the centre of the tread

Correct tyre pressure ensures safety, optimum handling and longer life of the tyre



258 Tyre Pressure Gauge Pen Type

TYG

NEW!

Compact Pen type Tyre Pressure Gauge, designed to measure wheel pressure of trucks, SUVs, RVs, ATVs etc.

Ideal for dual wheels & other difficult to reach valves

Steel body with black zinc die cast chuck

Dual Chuck Design

30° Reverse chuck is designed for inner wheels or difficult to reach valves & straight chuck is used for outer wheels

4 sided chrome plated steel read out scale with easy to read graduations

SPECIFICATIONS

PRESSURE RANGE	10-150 PSI	1-11 BAR
ACCURACY	±3 PSI	±0.2 BAR
GRADUATED IN UNITS	PSI, BAR, kPa & kg/cm2	
LEAST COUNT	2 PSI, 0.25 BAR, 20 kPa, 0.25 kg/cm2	



ORDERING INFORMATION

CAT NR.	OVERALL LENGTH		BOX QTY.
	(INCH)	(MM)	
TYG/10-150/D	12	300	10

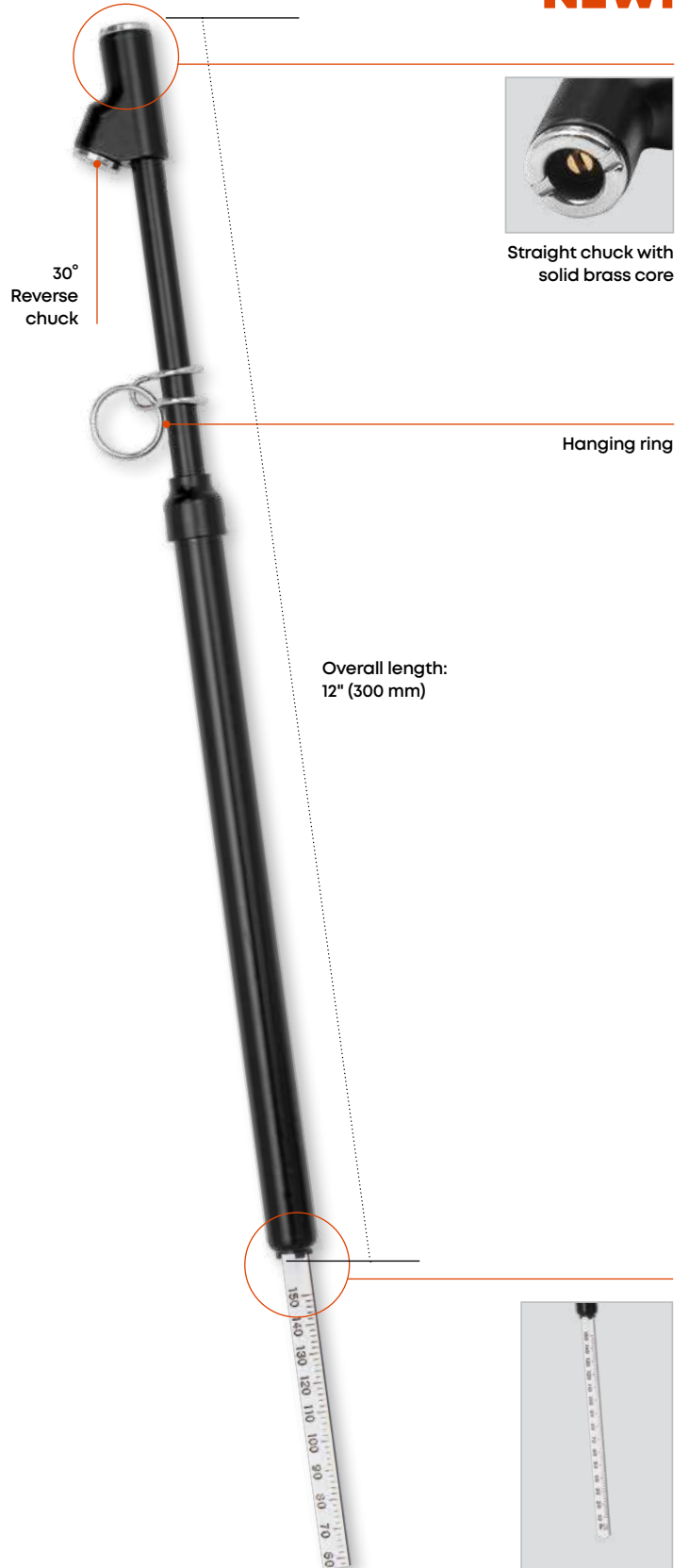

ALPHABETIC INDEX

A		
Axe - Fibreglass Handle		26
Automotive Tool Kit - 83 Piece		42
Aluminium Torque Wrenches		57
Adjustable Wrenches		76
Air Operated Grease Gun		159
Air Operated Grease Ratio Pump 50:1		178
Air Blow Gun	Standard	271
	Professional	271
Air Operated		198
Double Diaphragm Pumps		
Air / Water Hose Reel		215
Air / Water Hose Reels - E Series		214
Air Operated Transfer Pump		190
Air Operated Oil Ratio Pump		192
Air Operated Oil Ratio Pump - 6.5:1		191
Air Operated		194
Stainless Steel Pump - 3:1		
Anti-shock Ball Pein Hammer		18
Anti-shock Drilling Hammer		18
Automotive		62
Maintenance Tool Kit - 13 Pc		
B		
Brass Head Sledge Hammers		15
Indestructible Handle		
Ball Pein Hammers		16
Indestructible Handle		
Ball Pein Hammers		21
Fibreglass Handle		
Blacksmith's Hammers		24
Fibreglass Handle		
Blacksmith's Hammers		17
Indestructible Handle		
Bench/ Mechanic's Vices		80
Button Head Couplers		167
Bucket Greaser		172
With Quick Lock Coupler		
Bucket Grease Pumps	With Quick Lock Coupler	172
	Grease Pump - Heavy Duty	173
	Portable Greasing System	177
	Bucket Greasers	174
	Foot Operated	176
Battery Transfer Pump		254
Bucket Oil Pumps		189
Bucket Oil Pump With Meter		189
Battery Powered Grease Gun		160
C		
Club Hammers		11
Indestructible Handle		
Copper Head Sledge Hammers		14
Indestructible Handle		
Cross Pein Hammers		17
Indestructible Handle		
Claw Hammer		17
Indestructible Handle		
Cross Pein Hammers		24
Fibreglass Handle		
Claw Hammer - Fibreglass Handle		25
Cantilever Tool Box with Tools		48
Cushion Grip Torque Wrenches		55
Classic Torque Wrenches		56
Circlip Pliers		75
Couplers	Quick Lock Grease Coupler	164
	Quick - Disconnect	165
	Grease Coupler	
	Hydraulic Coupler Standard	166
	Hydraulic Coupler Professional	166

	Hydraulic Couplers Heavy Duty	167
	Button Head Couplers	167
Continuous Duty	Regular Flow	226
Electric Diesel Pump		
	High Flow	227
Cordless Sitalamp - 3 Head Design		102
D		
Drilling Hammers Fibreglass Handle		22
Double Face Plastic Mallet		29
Double Open End Spanners		74
Digital Air Pressure Gauge		273
Drum Trolley Low Profile		266
Drum Wrench		266
Drum Dolly - 4 Wheel		267
Drum Cradle		267
Drum Trolleys - Heavy Duty		268
Drum Cart - Heavy Duty		270
DEF Pumps	Electric	248
	DEF Dispenser	249
	Battery Transfer Pump	254
	Dry Cell DEF Pump	255
	Rechargeable DEF Pump	256
	Electric Drum/ IBC Pumps	257
	Rotary Drum Pump	258
	Stainless Steel	
	DEF Transfer Systems	252
	Electric DEF Transfer Pumps	250
DEF Control Nozzle	Automatic	260
	Manual	260
Digital Oval Gear Fuel Meter		239
Digital Fuel Meter In-line		240
Digital Fuel Meter - Professional		241
Diesel Refilling System Mini Browser		229
Dual Plane Fuel Nozzle Swivels		244
Drain Pans		222
Dead Blow Hammers		27
Fibreglass Handle		
Digital Fuel Meter In-line		240
E		
Engineer's Hammer		23
Fibreglass Handle		
Ezee Lube Kit		169
Electric Drum/ IBC Pumps		257
Electric Fuel Pump		227
Continuous Duty High Flow		
Electric Diesel Pumps		232
Electric Diesel Pump - Heavy Duty		233
Electric Waste Oil Pump		216
Ezee Flow Pump		187
Electric Diesel Pumps - V Series		231
Electric DEF Transfer Pumps		250
F		
Flashlight	Spotlight - Waterproof	128
	Pen Light - UV & Laser	129
	Penlight	130
	Penlight - Pivoting Head	131
	Pick-Up Light Telescopic	132
	Flashlight - Slim Pocket Size	133
	Neck Light - Rechargeable	134
	Flashlight - Superbright	135
	Worklight - Slim Line	136
	Worklight - Multiple Functions	137
Floodlights	12W	141
	15W	142
	15W Compact	143
	15W Super Cool	144

	18W Super Cool	145
	27W	146
	30W	147
	45W	148
	48W	149
	Foot Operated Bucket Grease Pump	176
	Filter Regulator Combination	272
	Filter Regulator & Lubricator - 2 Piece	272
Fuel Pumps	Heavy Duty High Flow Electric Fuel Pumps - Explosion Proof	223
	Heavy Duty Electric Fuel Pumps Explosion Proof	224
	Continuous Duty Electric Diesel Pump	226
	Electric Fuel Pump Continuous Duty - High Flow	227
	Fuel Dispenser	228
	Diesel Refilling System Mini Browser	229
	Open Bowser AC Diesel Refilling System	230
	Electric Diesel Pumps - V Series	231
	Electric Diesel Pumps	232
	Electric Diesel Pump Heavy Duty	233
	Industrial Rotary Drum Pumps	234
	Rotary Booster Pump 3:1	235
Fuel Meters	Mechanical Diesel Meter	236
	Mechanical Fuel Meter Oval Gear	237
	Mechanical Fuel Meter In-line	238
	Digital Oval Gear Fuel Meter	239
	Digital Fuel Meter In-line	240
	Digital Fuel Meter - Professional	241
Fuel Control Nozzles	Fuel Control Nozzles - Manual	242
	Fuel Control Nozzles Automatic	242
	Fuel Control Nozzles Automatic E Series	243
	Fuel Control Nozzle Metered	243
	Fuel Nozzle Swivels Dual Plane	244
	Fuel Dispensing Kits	244
	Filter Wrench	245
	Fuel Filter	246
	Fuel Filter - Portable	245
	Fuel Filter Spin-On Cartridge Style	247
Funnels	Smart	208
	Fuel & Oil	209
	Conical	209
	Plastic Funnel Set - 4 Pieces	210
	Flexible	211
	Flexible Spout Measures	208
	Foldable Worklight - AC Powered	106
	Flexible Funnels	211
	Fuel Dispenser	228
	Fuel Control Nozzles Automatic E Series	243
G		
Gear Pullers	Ratcheting	65
	Regular	64
	G Clamps - General Purpose	80
Grease Guns	The Ultimate Lever Grease Gun	154
	Lever Grease Gun Heavy Duty	154
	Lever Grease Gun - Dual Piston	155
	Lever Grease Guns Heavy Duty 'V' Series	156
	Lever Grease Gun 'V' Series	156
	Lever Grease Gun - Super Value	157
	Mini Lever Grease Gun	157
	Pistol Grip Grease Gun	158
	Mini Pistol Grease Gun - Deluxe	158
	Mini Grease Gun Push Type	159

	Air Operated Grease Gun	159
	Battery Powered Grease Gun	160
	USB Rechargeable	162
	Battery Grease Gun	162
	Grease Gun Hoses	168
	Grease Gun Steel Extensions	168
	Grease Cartridges	169
	Grease Fittings	170
	Grease Feeders	171
	Grease Pump - Heavy Duty	173
Grease Pumps	Bucket Greaser With Quick Lock Coupler	172
	Grease Pump - Heavy Duty	173
	Bucket Greasers	174
	Grease Pump - Foot Operated	176
	Portable Greasing System	177
	Air Operated Grease Ratio Pump - 50:1	178
	Grease Ratio Pump High Volume	184
Grease Pump Kits	With HD Trolley	180
	With Drum Cart	183
Grease Control Valve	Professional	185
	Booster	185
	Metered	186
	Grease Gun Holder - Magnetic	163
H		
Hammers: Indestructible Handle	Ball Pein	16
	Brass Head Sledge	15
	Claw	17
	Club	11
	Cross Pein	17
	Copper Head Sledge	14
	Sledge	12
Hammers: Fibreglass Handle	Ball Pein	21
	Blacksmith's/ Cross Pein	24
	Claw	25
	Drilling	22
	Engineer's	23
	Sledge	20
	Dead Blow	27
Hammers: Steel Handle	Ball Pein	18
	Drilling	18
Hydraulic Jacks	Bottle	66
	Floor	67
	Hexagon Key Sets	68
Hacksaw	Super-cut Hi-tension	79
	Professional	79
	Handyman's	78
Handyman's Hacksaw		78
Hand Sockets		82
Headlamps	Rechargeable With Hand Sensor	138
	Dual Mode & Hand Sensor	139
	High Powered Strip Light	140
Hydraulic Couplers	Standard	166
	Professional	166
	Heavy Duty	167
	Heavy Duty High Flow Electric Fuel Pumps - Explosion Proof	223
	Heavy Duty Electric Fuel Pumps Explosion Proof	224
Hose Reels	Metal	212
	Air / Water - E Series	214
	Air / Water	215
Hydraulic Oil Hoses		206
I		
Impact Wrench		32
Insulation Pliers		75

Impact Sockets Hex		86
L		
Light Bars	36W	150
	72W	151
	120W	152
Lever Grease Gun	Ultimate	154
	Heavy Duty	154
	Dual Piston	155
	Heavy Duty - 'V' Series	156
	'V' Series	156
	Super Value	157
	Mini	157
Low Profile Truck Drain		220
Lever Action Barrel Pump		187
M		
Mallets	Rubber	28
	Double Face - Plastic	29
Magnetic Tool Holder - Heavy Duty		53
Multi Purpose Vice		81
Mechanic's/ Bench Vices		80
Mini Lever Grease Gun		157
Mini Grease Gun Push Type		159
Mini Pistol Grease Gun - Deluxe		158
Metal Hose Reels		212
Magnetic Drain Plug Remover Tool		63
Magnetic Power Tool Holder		51
Magnetic Can Holder		51
Magnetic Hook		51
Magnetic Pads		52
Measuring Jugs - Stackable		207
Mechanical Fuel Meter Oval Gear		237
Mechanical Fuel Meter In-line		238
Mini Tool Box		46
N		
Nylon Tool Bags		44
Nylon Chemical Pumps		261
Nail Punches Cushion Grip		30
Neck Light - Rechargeable		134
O		
Oil Pumps	Lever Action Barrel Pump	187
	Ezee Flow Pump	187
	Rotary Barrel Pump	188
	Rotary Barrel Pump - V Series	188
	Bucket Oil Pumps	189
	Bucket Oil Pump With Meter	189
	Air Operated Transfer Pump	190
	Air Operated Oil Ratio Pump	191
	Air Operated Oil Ratio Pump - 6.5:1	192
	Air Operated Stainless Steel Pump - 3:1	194
	Air Operated Double Diaphragm Pumps	198
	Electric Oil Pumps	197
	Oil Pump Kits With HD Trolley	195
	Oil Pump Kits With Drum Cart	196
Oil Management System		200
Oil Meter	Mechanical	202
Oil Control Gun	Mechanical	203
	Electronic Preset	204
	Regular	205
Oil Cans V Series		206
Open Bowser		230
AC Diesel Refilling System		230
P		
Pliers	Insulation	75
	Circlip	76
Professional Hacksaw Frame		79

Pear Head Ratchet Handle		95
Penlight	Regular	130
	Penlight Pivoting Head	131
Pistol Grip Grease Gun		158
Portable Greasing System		177
Portable Fuel Filter		245
Plastic Lever Pump		259
Plastic Rotary Pump		261
Plastic Lever Pump - Valve		262
Pocket Pry Bars		61
Plastic Truck Drain		221
Q		
Quick Change		65
Ratcheting Gear Pullers		164
Quick Lock Grease Coupler		165
Quick - Disconnect Grease Coupler		165
R		
Rolling Tool Cabinet - 27"		34
Rolling Tool Cabinet - 27"		36
Rolling Tool Cabinet - 27"		38
Rubber Mallets		28
Ratcheting Torque Wrenches		54
Reversible Ratcheting Spanners		72
Ring Spanners		73
Ratchet Handle	Slim Line	94
	Round Head	95
	Pear Head	95
Rechargeable Battery Grease Gun		162
Rechargeable DEF Pump		256
Rotary Drum Pump - Stainless Steel		258
Rotary Barrel Pump		188
Rotary Barrel Pump - 'V' Series		188
S		
Sledge Hammers	Brass Head	15
	Indestructible Handle	
	Copper Head	14
	Indestructible Handle	
	Sledge, Fibreglass Handle	20
	Sledge, Indestructible Handle	12
Screwdriver Set	7 Pc, Insulation	71
Spanners	Reversible Ratcheting	72
	Ring	73
	Double Open End	74
Super Cut Hi-Tension Hacksaw Frame		79
Sockets	Hand Sockets	82
	Impact Sockets Hex	86
	Accessories	88
	Socket Sets in blow moulded cases	90
	Socket Sets on rails	92
	Socket Sets in metal cases	93
Slim Line Ratchet Handle		94
Scoop & Swipe Set		175
Siphon Pumps		263
Siphon Pump With Back Flow Valve		264
T		
Tool Holder - Magnetic - Heavy duty		53
Tool Storage	27 Inch Rolling Tool Cabinet	34
	27 Inch Rolling Tool Cabinet	36
	27 Inch Rolling Tool Cabinet	38
	Universal Tool Kit - 149 Piece	40
	Automotive Tools Kit - 83 Piece	42
	Nylon Tool Bags	44
	Work Bench - Heavy Duty	45
	Mini Tool Box with Lid	46
	Cantilever Tool Box With Tools	48
	5 Tray Cantilever Tool Box	50
	Tool Cart Accessories	51
	Magnetic	

	Magnetic Pads	52
	Magnetic Tool Holders Heavy Duty	53
Torque Tools	Ratcheting Torque Wrenches	54
	Torque Wrenches Cushion Grip	55
	Classic Torque Wrenches	56
	Aluminium Torque Wrenches	57
	Torque Multipliers	58
	Torque Extension Bars 10 Pc Kit	59
Torque Wrenches	Ratcheting	54
	Cushion Grip	55
	Classic	56
	Aluminium	57
Torque Multipliers		58
Tyre Levers		60
Telescopic Wheel Wrench		77
Tap & Reamer Wrenches		78
Tyre Inflator Gauge	For Cars	274
	For Trucks	275
Truck Drain	Low Profile	220
	Plastic	221
Torque Extension Bars - 10 Pc Kit		59
Two-In-One Transfer Pump		264
Tyre Pressure Gauge - Pen Style		276
The Ultimate Lever Grease Gun		154
U		
Universal Tool Kit - 149 Piece		40
Underhood Light	Magnetic Ends	125
	High Intensity & Glare Free	126
V		
Vice	Multi Purpose	81
	Mechanic's/ Bench	80
W		
Wrenches	Strap Wrenches	60
	Telescopic	77
	Adjustable	76
	Tap & Reamer Wrenches	78
Worklight	Cable Reel	97
	Impact Resistant	98
	Dual Power	100
	Cordless Sitelamp 3 Head Design	102
	Site Lamp - AC Powered	104
	Site Lamp With Tripod AC Powered	105
	Foldable Worklight AC Powered	106
	Glare Free - Pocket Sized	107
	270° Swivelling With Magnetic Base	108
	360° Rotating Hook	109
	Folding	110
	Intensity Control	112
	Intensity Control & Battery Display	114
	UV & Dual Charging	116
	Folding Worklight Intensity Control	118
	3-in-1 Quick Connect Worklight	120
	Inspection Light Flexible	122
	360° Swivel	123
	Inspection Lamp Unbreakable	124
	Underhood Light Magnetic Ends	125
	Underhood Light High Intensity - Glare Free	126
Waste Oil Drain Pressurized		218

Waste Oil Drain	219
Work Bench Heavy Duty	45

GET IN TOUCH WITH US!

GROZ has an extensive sales team across India, to help you out with any query related to product, application or installation.

AREA	EMAIL ADDRESS
NORTH	
Bhiwadi	grozgurgaon6@groz-tools.com
Chandigarh	grozchandigarh@groz-tools.com
Delhi	grozdelhi@groz-tools.com
Faridabad	grozgurgaon1@groz-tools.com
Ghaziabad	grozghaziabad@groz-tools.com
Gurugram	grozgurgaon3@groz-tools.com
Lucknow	grozlucknow@groz-tools.com
Ludhiana	grozludhiana@groz-tools.com
Rudrapur	grozrudrapur@groz-tools.com
EAST	
Bhubaneshwar	grozorissa@groz-tools.com
Durgapur	grozdurgapur@groz-tools.com
Guwahati	grozguwahati@groz-tools.com
Jamshedpur	grozjamshedpur@groz-tools.com
Kolkata	grozkolkata@groz-tools.com
Patna	grozpatna@groz-tools.com
Rourkela	grozrourkela@groz-tools.com
WEST	
Ahmedabad	grozahmedabad@groz-tools.com
Indore	grozindore@groz-tools.com
Jaipur	grozjaipur@groz-tools.com
Mumbai	grozmumbai@groz-tools.com
Nagpur	groznagpur@groz-tools.com
Pune	grozpune1@groz-tools.com
Raipur	grozraipur@groz-tools.com
Rajkot	grozrajkot@groz-tools.com
Satna	grozsatna@groz-tools.com
Udaipur	grozudaipur@groz-tools.com
Vadodara	grozvadodara@groz-tools.com
SOUTH	
Bengaluru	grozbengaluru@groz-tools.com
Chennai	grozchennai@groz-tools.com
Coimbatore	grozcoimbatore@groz-tools.com
Hubli	grozhubli@groz-tools.com
Hyderabad	grozhyderabad@groz-tools.com
Kerala	grozkerala@groz-tools.com
Vizag	grozvizag@groz-tools.com
Vijayawada	grozvijayawada@groz-tools.com

All spare parts and kits are available. For any service and spare parts related queries, write to us at care.dom@groz-tools.com



CONNECT WITH US!



CI-37 | AUGUST 2025



GROZ ENGINEERING TOOLS PVT. LTD.
GROZ NET INDUSTRIES
Village Kherki Daula, National Highway-8,
Gurugram-122004, Haryana, India

Tel +91.124.282.7700
Email (India) india@groz-tools.com
URL www.groz-tools.com

For circulation in INDIA & SAARC Nations

The GROZ name, GROZ logo and the  mark are trademarks of Groz Engineering Tools Pvt. Ltd., India